

Interface Converter

## Instruction Manual

LAN ↔ RS-422/485

SI-65

SI-65A

SI-65A-L

SI-65FA

SI-65FA-L

The CD-ROM attached to a product contains the newest English and Japanese instruction manuals in a PDF format. Please also refer to them.

## Introduction

Thank you for your purchase of SI series. To use it correctly, you are advised to read and understand this instruction manual thoroughly. Keep this together with the warranty.

### ■ ■ Notice ■ ■

- Under the copyright laws, it is prohibited to reprint or duplicate any part or the whole of this instruction manual without priority from LINEEYE CO., LTD. ("LINEEYE")
- All company and product names in this manual are trademarks or registered trademarks of their respective companies.
- The contents of this manual and specifications of the products are subject to change without notice.
- This manual has been designed and edited with great care to give you all information. If you have any questions, feel free to direct your inquiries to LINEEYE.
- LINEEYE makes no warranty or guarantee, either expressed or implied with respect to its quality, performance, merchantability, or fitness for a particular purpose. LINEEYE shall not be liable for direct, in-direct, special, incidental, or consequential damages resulting from any defect in the product. The warranty and remedies set forth above are exclusive and in lieu of all others.

Copyright © 2016-2019 LINEEYE CO.,LTD. All rights reserved.

## Safety Information

Be sure to read the following

LINEEYE has developed and manufactured this product for purpose of using with electrical devices such as a computer, a personal device, a measurement device, semiconductor manufacturing equipment, a vending machine, a sequencer, display equipment and so on. LINEEYE does not manufacture this product under the purpose of using with equipment which may cause malfunction to do harm to the human body: control equipment for nuclear, aircraft equipment, life maintenance equipment, traffic signals, etc. Therefore, LINEEYE makes no guarantee with the mentioned-above use. If you use this product for the purposes mentioned above, please contact LINEEYE considering safety like Fail Safe under your responsibilities.

### Danger Level



Should the device be used without following these symbols, there is a possibility of accidents, such as a death or a serious injury, occurring.



Should the device be used without following these symbols, there is a possibility of accidents, such as an injury and material damage, occurring.

\*"Injury" indicates injury, burn, an electric shock, or the like which does not require hospitalization or the extended hospital visit. "Material damage" indicates damage related to a house, a building, furniture, apparatus, livestock or a pet.



- Do not disassemble or modify the converter and AC adapter.  
This may cause overheating, a fire, an electric shock, injury or unit malfunction.
- Stop using the converter immediately when smoke, smells, or unusual sound emanates from itself.  
Continuous use may cause a burn, fire, or electric shock.
- Keep the products dry. Keep them away from water.  
Failure to do so may cause overheating, an electric shock, or unit malfunction.
- Do not insert the metal scrap or the rubbish such as lead wires into the opening.  
Doing so may cause overheating, an electric shock, or unit malfunction.
- Never touch the converter and AC adapter with wet hands.  
Doing so may cause an electric shock.
- Remove the dust on the AC adapter periodically to prevent the heat and ignition.

- Never use the converter in the place where an inflammable gas leaks.  
Doing so may cause ignition.
- Do not conduct the installation or wiring work when power is applied.  
Doing so may cause an electric shock or unit malfunction.
- Do not use the damaged cables.  
Doing so may cause fire by overheating.
- Use the included AC adapter or ones specified by LINEEYE.  
Failure to do so may cause overheating, fire, an electric shock, or injury.
- Never touch the converters and cables while thunderbolts are occurring.
- Do not connect the power cord to an outlet that has an illegal number of connections.  
Doing so may cause fire by overheating.



Caution

- Do not install the converter in the unstable or vibrating place.  
Doing so may cause unit malfunction or injury.
- Do not install the converter in any temperature and humid places, or any places which has the extreme temperature change.  
Doing so may cause unit malfunction.
- Do not install the converter in any places exposed to direct sunlight.  
Doing so may cause a burn or unit malfunction by overheating.
- Be sure not to short-circuit the pins on the connector.  
Doing so may cause unit malfunction or injury.
- Use the included AC adapter with the converter only.  
Failure to do so may cause fire or injury by overheating.
- Be sure to hold the converter when you disconnect the AC adapter from it.  
Failure to do so may cause fire or an electric shock by damaging a cord.
- Please do not damage the power cable by pulling, stamping, or tearing.  
This may result in a injury, an electric shock, fire, explosion and or a breakdown due to overheating.
- Do not place the cord of the AC adapter near heating equipment.  
Doing so may cause fire or an electric shock by melting the cord's cover.

## ■■ Contents ■■

Chapter 1 Before Using The Product 5	Chapter 6 COM Port Redirector ..... 30
1-1. Unpacking and Product Composition.....5	6-1. About Virtual COM Port .....30
1-2. How to read this instruction manual .....5	6-2. Basic Setting.....30
1-3. Overview .....6	6-3. Install COM Port Redirector....30
1-4. Specifications .....6	6-3. Install COM Port Redirector....31
Chapter 2 SI-65(A/FA) Usage..... 7	6-4. COM Port Redirector .....31
2-1. SI-65(A/FA) Overview and Features.....7	Chapter 7 Documents.....32
2-2. SI-65 Panel Explanation .....8	7-1. Option.....32
2-3. SI-65A Panel Explanation.....9	7-2. Ordering information .....32
2-4. SI-65FA Panel Explanation..... 11	7-3. LAN Connector Specification 33
2-5. SI-65(A/FA) Hardware Setup..13	7-4. General-purpose I/O pins.....33
2-6. SI-65(A/FA) Cable Connection ..... 15	7-5. Factory setting.....34
2-7. SI-65(A) Power Source.....16	7-6. How to apply the factory setting .....35
2-8. SI-65FA Power Source.....17	7-7. Installation Method .....37
Chapter 3 Basic Configuration..... 18	7-8. Transmission distance of RS-422/485 ....39
3-1. Connect to the LAN network...18	Chapter 8 Warranty and After-Sales Service.... 40
3-2. Basic configuration .....18	8-1. Troubleshooting .....40
3-3. Default IP address .....19	8-2. Warranty and Repair .....42
3-4. Usage of DeviceInstaller.....19	8-3. After-Sales Service.....42
3-5. Confirm IP address.....20	
3-6. Assign IP address .....21	
Chapter 4 Configuration Using Web Manager .22	
4-1. Web Manager Usage .....22	
4-2. Communication conditions of serial port.24	
4-3. Set up LAN connection mode..24	
4-4. Other Setting .....25	
Chapter 5 Setup Example..... 26	
5-1. Server mode usage .....26	
5-2. Client Mode Usage .....27	
5-3. Using two units of converter....28	

# Chapter 1 Before Using The Product

---

## 1-1. Unpacking and Product Composition

---

Make sure of the following when unpacking the product.

Please let your LINEEYE distributor or LINEEYE know if you find any damage to the product caused by transportation, or if there are accessories lacking.

<input type="checkbox"/> Converter	: 1
<input type="checkbox"/> AC Adapter	: 1 *1*3
<input type="checkbox"/> Utility CD-ROM	: 1 *2*3
<input type="checkbox"/> Instruction Manual	: 1*3
<input type="checkbox"/> Warranty	: 1

- \*1 This option is not included in SI-65FA package. The domestic model of SI-65/SI-65A (for Japan) includes AC adapter of 100V (VFN-650B) while the model for abroad includes AC adapter of 100V - 240V (6A-181WP09).
- \*2 This CD-ROM includes manuals and tools for setup. Please read the README.txt for further details.
- \*3 -NS models do not have these items.

## 1-2. How to read this instruction manual

---

First, please read instruction about power supply and how to connect the device at the chapter of the model. Then read chapter 3, chapter 4, and chapter 6 for the details of the configuration and IP address setting. In this article, "SI-65(A)" means SI65 and SI-65A. "SI-65(A/FA)" means SI-65, SI-65A, and SI-65FA.

### ● Description of I/O pins on the XPort

The description of I/O pins of XPort at configuration differs depending on the version of the WEB manager. And the version of the WEB manager also differs depending on the version of the XPort. Please refer to the following information to apprehend the meaning of the description at configuration.

Web Manager Ver1.8.0.1 or before : CP0, CP1, CP2

Web Manager Ver1.9.0.1 or later : CP1, CP2, CP3. (Examples in this manual use this description)

### ● About SI-65A-L and SI-65FA-L

SI-65A and SI-65FA have two models for each: SI-65A / SI-65A-L and SI-65FA / SI-65FA-L (-L models are wall-hanging model).

SI-65A and SI-65A-L have same function. SI-65FA and SI-65FA-L have same function. When this manual refers to "SI-65A", it refers to both SI-65A and SI-65A-L while when the manual refers to "SI-65FA" it refers to both SI-65FA and SI-65FA-L.

Note: SI-65A-L and SI-65FA-L do not support L bracket and DIN rail mounting plate.

### 1-3. Overview

SI-65, SI-65A, and SI-65FA are communication converters which convert asynchronous communication on RS-422/485 into TCP/IP or UDP/IP communication on Ethernet. These converters have built-in Lantronix XPort at the LAN interface part and the RS-422/485 interface supports 4-wire full duplex and 2-wire half duplex. Thus It can be applied to various systems which requires liability. You can control the device which has a serial port from a PC on the network by socket communication. By using COM port redirector, which is included in the CD-ROM, you can use it like com port communication. It is also possible to extend the serial line without PC by connecting the two devices by LAN.

### 1-4. Specifications

	SI-65	SI-65A	SI-65A-L	SI-65FA	SI-65FA-L <sup>5</sup>
Serial	RS-422/485				
	Interface		6 poles terminal block, 5.08mm pitch		
			5 poles terminal block, 5.08mm pitch		
			Able to set the terminator.		
	Synchronous Method		Asynchronous		
	Baud Rate (bps)		300/600/1200/2400/4800/9600/19200/38400/57600/115200/230400/ 460800 <sup>*1</sup> /921600 <sup>*1</sup>		
	Data Frame Structure		Data (7 or 8) + Parity (Even, Odd or None) + Stop (1 or 2)		
	Flow Control		Xon/off, Line Monitoring		
LED Display		SD,SD/RD, DRIVER ACTIVE			
Isolation		-		Photo coupler (Signal part) Isolation transformer (Power source part)	
Surge Protection		15KV ESD			
LAN	Interface		Ethernet IEEE802.3 RJ-45 connector 10BASE-T/100BASE-TX		
	Protocol		ARP,TCP/IP,UDP/IP,ICMP,SNMP,TFTP,Telnet,DHCP,BOOTP,HTTP,AutoIP		
	LED Display		10BASE-T、100BASE-TX、Activity、Link、Full/Half duplex		
	Transformer Insulation		1500V		
Management		Web manager, Telnet connection			
Power Supply		DC5 ~ 12V	DC5 ~ 30V	AC85 ~ 264V (50/60Hz)	
Power Consumption		3.6W / 4.9VA <sup>*2</sup>	2.9W / 3.8VA <sup>*2</sup>	2.7W (at AC240V)	
Operating Temperature, Humidity		-10 ~ +50°C <sup>*3</sup> , 10 ~ 95%RH	-25 ~ +75°C, 10 ~ 95%RH	-20 ~ +60°C, 10 ~ 95%RH	
Storage Temperature, Humidity		-20 ~ +80°C, 10 ~ 95%RH	-25 ~ +85°C, 10 ~ 95%RH	-25 ~ +75°C, 10 ~ 95%RH	
Compatible standards		-	CE (Class A) EMC(EN61326-1:2013)	-	
External Dimension (W x D x H)		65×90×24mm		89×90×24mm <sup>*5</sup>	90×100×22mm   114×100×22mm <sup>*5</sup>
Weight		195g		200g	280g
Accessories		AC adapter <sup>*4</sup> , Utility CD-ROM, Instruction manual, Warranty			

\*1 You need to change the performance setting of the XPort when you use at 460.8kbps or 921.6kbps.

\*2 In the case of using the attached AC adapter (AC100V).

\*3 When the power supply voltage, which is supplied from the terminal block, is DC10V or higher the operating temperature is limited up to +40 degree.

\*4 Not included in SI-65FA.

\*5 Includes attaching portion to a wall.

## Chapter 2 SI-65(A/FA) Usage

### 2-1. SI-65(A/FA) Overview and Features

SI-65 is a DC powered model. SI-65A is a DC powered model which is adaptive to cold district. SI-65FA has a built-in AC power supply and has a insulator between the interfaces (Ethernet and the RS-422/485). These three models have the same function as to the conversion function. You can set an IP address to the converter and the converter communicates with the Ethernet device by TCP/IP or UDP/IP. When it receives data from serial side, it transmits the data by putting it on the data part of the TCP/IP or UDP/IP packet. When it receives data from the Ethernet side, it extracts the data part of the TCP/IP or UDP/IP packet and transmits it to the serial part.

#### ■ SI-65(A) Block chart

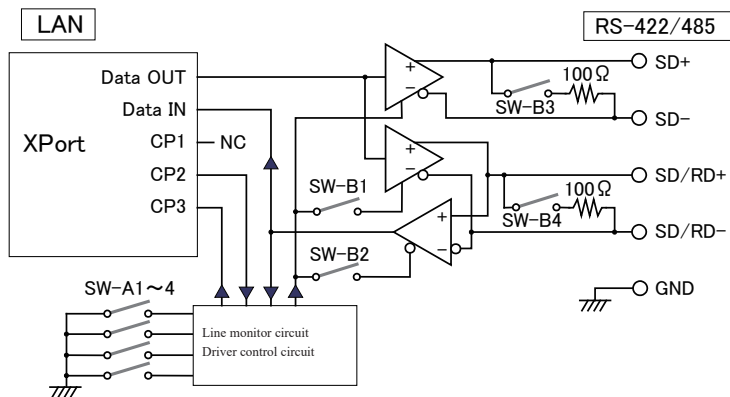

#### ■ SI-65FA Block chart

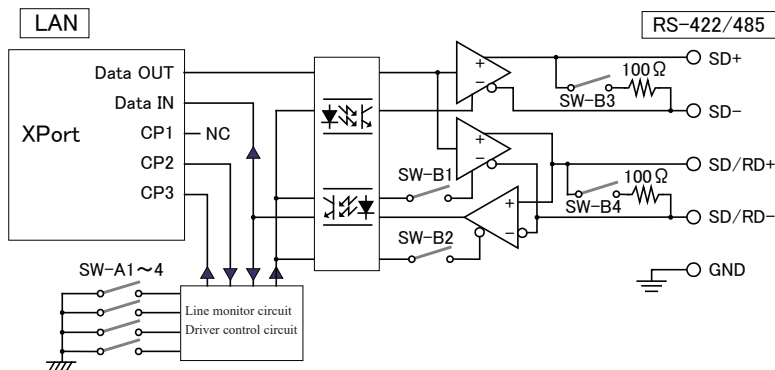

## ■ SI-65(A/FA) Line Monitoring Function

RS-485 communications of two-wire half duplex is required to send data after confirming that any devices have not sent data into the RS-485 line. The line monitoring function allows to detect that any devices have not sent data into the RS-485 line, and to conduct the flow control. To use this function, the flow control of built-in XPort is required to set to CTS/RTS (Hardware).

RS-485 Line Condition	Flow Control Condition
The period of time from when to detect a space bit of the data in the RS-485 line sent by another device, to when not to get to continuously detect a space bit over internal timer time of the converter, while the RS-485 driver of the converter is not active.	Prohibits sending data from the converter to the RS-485 circuit.
The period of time when not to detect a space bit in the RS-485 line which another device continuously sends over internal timer time of the converter, or when the RS-485 driver of the converter is active.	Permits to send data from the converter to the RS-485 circuit.

\* This function allows the flow control to operate in a direction of sending only. The flow control in a direction of receiving does not operate.

## 2-2. SI-65 Panel Explanation

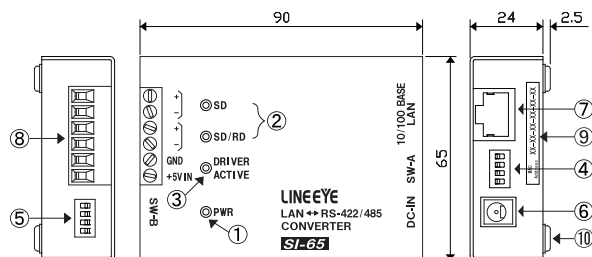

No.	Name	Explanation	Note
1	Power Supply LED	It lights when the SI-65 is powered.	
2	Data Status LED	“SD” lights when a data is transmitted from LAN to RS-422/485 “SD/RD” lights when a data is transmitted from RS-422/485 to LAN.	
3	Driver Status LED	It lights when the driver for RS-485 is active.	
4	Dip Switch A	To configure line monitoring function and driver control.	→ [ 2-5. ]
5	Dip Switch B	To configure communication method, terminal resistance, etc.	→ [ 2-5. ]
6	AC Adapter Jack	A socket to connect to an AC adapter. (Non-polar)	→ [ 2-7. ]
7	Ethernet Connector	Ethernet IEEE802.3 RJ-45 connector 10Base-T/100Base-TX auto-detection available.	→ [ 7-3. ]
8	RS-422/485 Terminal Block*1	5.08mm pitch 6pole terminal block (Press-to-screw type) Standard Torque:0.25Nm/M3.	→ [ 2-6. ]
9	MAC address seal	The hardware address (MAC address) of the unit.	
10	Rubber foot	Rubber foot to place the unit horizontally.	→ [ 7-7. ]

\*1 Pin assignment of RS-422/485 terminal block

Terminal No.	Name	Full Duplex Mode <sup>*1</sup>		Half Duplex Mode <sup>*1</sup>	
		I/O Direction <sup>*2</sup>	Description	I/O Direction <sup>*2</sup>	Description
1	SD+	Out	Transmission Data+	-	Cannot use <sup>*3</sup>
2	SD-	Out	Transmission Data-	-	Cannot use <sup>*3</sup>
3	SD/RD+	In	Reception Data +	I/O	Transmission/Reception Data +
4	SD/RD-	In	Reception Data -	I/O	Transmission/Reception Data -
5	GND	-	Signal Grand <sup>*4</sup>	-	Signal Grand <sup>*4</sup>
6	+5V IN	-	External Power Input <sup>*5</sup>	-	External Power Input <sup>*5</sup>

\*1 Can switch by the dip switch.

\*2 "Out" means a direction to output signals from the converter. "In" means a direction to input signals to the converter. "I/O" means both directions to input and output.

\*3 Do not connect anything when using the half duplex mode.

\*4 Connect to GND (SG) of the target device → [2-6. SI-65(A/FA) Cable Connection]

\*5 About external power supply → [2-7. SI-65(A) Power Source]

## 2-3. SI-65A Panel Explanation

SI-65A

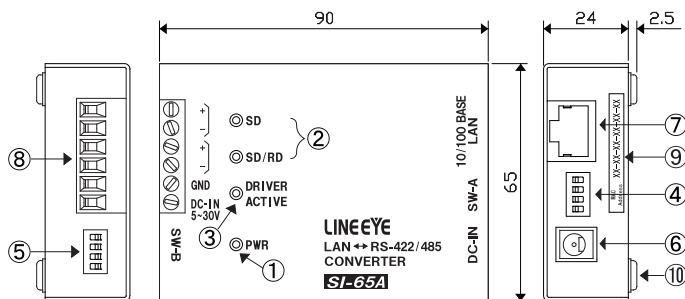

SI-65A-L (Wall hanging model)

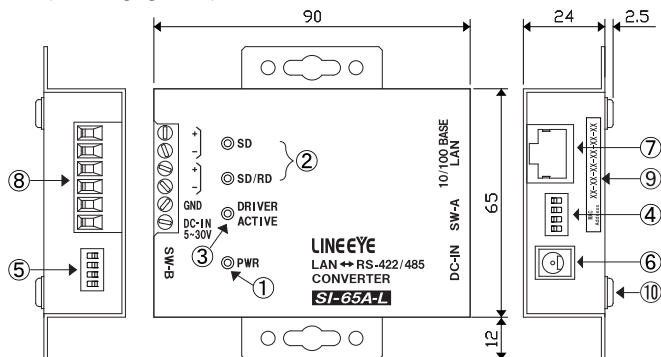

No.	Name	Explanation	Note
1	Power Supply LED	It lights when the SI-65A is powered.	
2	Data Status LED	The LED of "SD" lights when a data is transmitted from LAN to RS-422/485. The LED of "SD/RD" lights when a data is transmitted from RS-422/485 to LAN.	
3	Driver Status LED	It lights when the driver for RS-485 is active.	
4	Dip Switch A	Switches for configuration of the line monitoring function and driver control.	➔ [ 2-5. ]
5	Dip Switch B	Switches for configuration of the communication method, terminating resistance, etc.	➔ [ 2-5. ]
6	AC Adapter Jack	A socket to connect to an AC adapter. (Non-polar)	➔ [ 2-7. ]
7	Ethernet Connector	Ethernet IEEE802.3 RJ-45 connector 10Base-T/100Base-TX auto-detection available.	➔ [ 7-3. ]
8	RS-422/485 Terminal Block*1	5.08mm pitch 6pole terminal block (Press-to-screw type) Standard Torque:0.25Nm/M3.	➔ [ 2-6. ]
9	MAC address seal	The hardware address (MAC address) of the unit.	
10	Rubber foot	Rubber foot to place the unit horizontally.	➔ [ 7-7. ]

\*1 Pin assignment of RS-422/485 terminal block

Terminal No.	Name	Full Duplex Mode*1		Half Duplex Mode*1	
		I/O Direction*2	Description	I/O Direction*2	Description
1	SD+	Out	Transmission Data+	-	Cannot use*3
2	SD-	Out	Transmission Data-	-	Cannot use*3
3	SD/RD+	In	Reception Data +	I/O	Transmission/Reception Data +
4	SD/RD-	In	Reception Data -	I/O	Transmission/Reception Data -
5	GND	-	Signal Grand*4	-	Signal Grand*4
6	DC-IN 5 ~ 30V	-	External Power Input*5	-	External Power Input*5

\*1 Can switch by the dip switch.

\*2 "Out" means a direction to output signals from the converter. "In" means a direction to input signals to the converter. "I/O" means both directions to input and output.

\*3 Do not connect anything when using the half duplex mode.

\*4 Connect to GND (SG) of the target device ➔ [2-6. SI-65(A/FA) Cable Connection]

\*5 About external power supply ➔ [2-7. SI-65(A) Power Source]

## 2-4. SI-65FA Panel Explanation

SI-65FA standard model (Model number: SI-65FA)

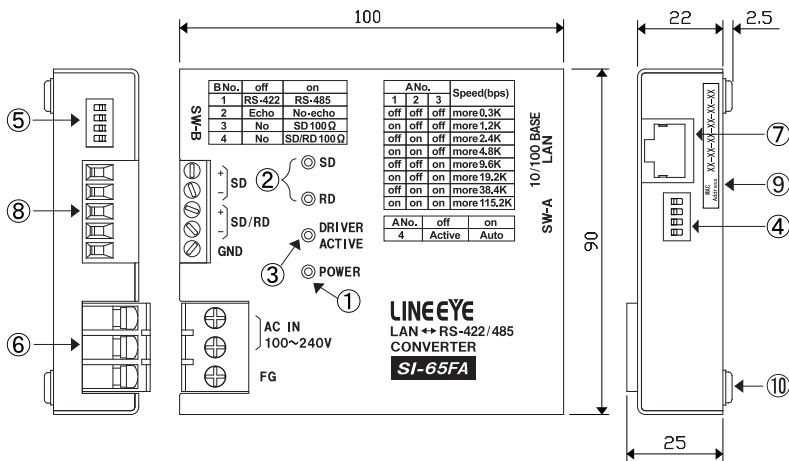

SI-65FA wall-hanging model (Model number: SI-65FA-L)

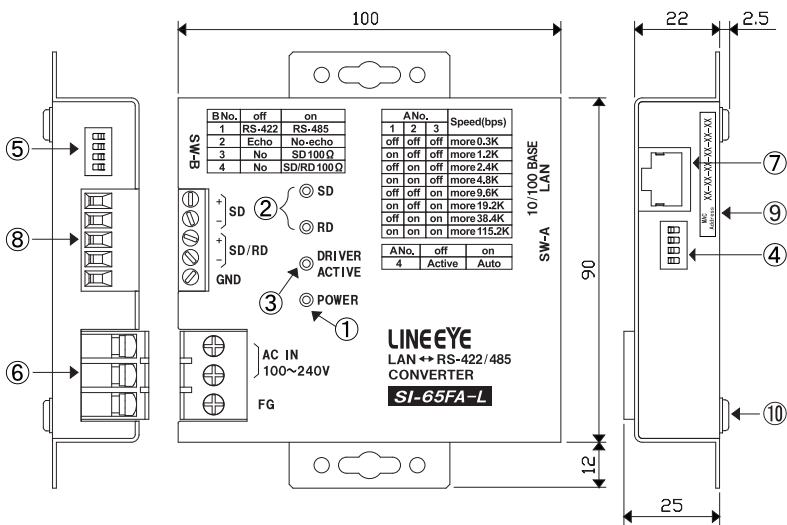

SI-65FA and SI-65FA-L have same function. About the detail of the shape of SI-65FA-L, please refer to “Attach on the wall (For SI-65FA-L)” at “7-8. Installation Method”.

No.	Name	Explanation	Note
1	Power Supply LED	It lights in green when the unit is powered.	
2	Data Status LED	The LED of "SD" lights when a data is transmitted from LAN to RS-422/485. The LED of "RD" lights when a data is transmitted from RS-422/485 to LAN.	
3	Driver Status LED	It lights when the driver for RS-485 is active.	
4	Dip Switch A	Switches for line monitoring function and driver control.	➔ [ 2-5. ]
5	Dip Switch B	Switches for communication method, terminating resistance, etc.	➔ [ 2-5. ]
6	Power Terminal Block*1	3 poles, 7.62mm pitch, M3 terminal screws (with cover) Standard Torque: 0.5Nm	➔ [ 2-8. ]
7	Ethernet Connector	10Base-T/100Base-TX, RJ-45 connector	➔ [ 7-3. ]
8	RS-422/485 Terminal Block*1	5 poles, 5.08mm pitch terminal block (Press-to-screw type) Standard Torque: 0.25Nm, Screw size: M3	➔ [ 2-6. ]
9	MAC address seal	The hardware address (MAC address) of the unit.	
10	Rubber foot	Rubber foot to place the unit horizontally.	➔ [ 7-7. ]

\*1 Power terminal block

Terminal Name	Description
AC IN	Power terminal (AC85 - 264V, 50/60Hz)
FG	Terminal for frame ground

\*2 Pin assignment of RS-422/485 terminal block

Terminal No.	Name	Full Duplex Mode *1		Half Duplex Mode *1	
		I/O Direction*2	Description	I/O Direction*2	Description
1	SD+	Out	Transmission Data+	-	Cannot use *3
2	SD-	Out	Transmission Data-	-	Cannot use *3
3	SD/RD+	In	Reception Data +	I/O	Transmission/Reception Data +
4	SD/RD-	In	Reception Data -	I/O	Transmission/Reception Data -
5	GND	-	Signal Grand *4	-	Signal Grand *4

\*1 Can switch by the dip switch B.

\*2 "Out" means a direction to output signals from the converter. "In" means a direction to input signals to the converter. "I/O" means both directions to input and output.

\*3 Do not connect anything when using the half duplex mode.

\*4 Connect to GND (SG) of the target device ➔ [2-6. SI-65(A/FA) Cable Connection]

## 2-5. SI-65(A/FA) Hardware Setup

The two 4-position dip switches on the converter allows you to conduct the following setups: the line monitoring function, the driver control method, terminator enable/disable, and echo back enable/disable.

### SW-A No.1-3 (Baud Rate Setup)

Following communication speed (baud rate) you wish to use, this setup is to set the internal timer used for the non-communication monitoring circuit and driver control circuit. Using this timer conducts to monitoring non-communication condition more than 16 bits in RS-485 line and to control the RS-485 driver.

\* Speed → [4-2. Communication conditions of serial port]

Speed (bps) [ ] indicates a representative example.	SW-A No.1	SW-A No.2	SW-A No.3	Internal Timer *1(ms)
Over300 [300, 600]	OFF	OFF	OFF	57
Over 1200 [1200]	ON	OFF	OFF	14.3
Over 2400 [2400]	OFF	ON	OFF	7.1
Over 4800 [4800]	ON	ON	OFF	3.6
Over 9600 [9600]	OFF	OFF	ON	1.8
Over 19200 [19200]	ON	OFF	ON	0.9
Over 38400 [38400, 57600]	OFF	ON	ON	0.45
Over 115.2k [115.2k to 920k]	ON	ON	ON	0.11

\*1 The internal timer is accurate at +10 to -10%.

### SW-A No.4 (Driver Control)

Selects two kinds of control methods in the RS-422/485 driver control line of the converter: active and auto.

SW-A	Meaning	OFF	ON
No.4	RS-422/485 transmission driver control	Active	Auto

#### ● OFF (Active) Setting

To keep the driver active, set the CP2 of the XPort I/O pin "L"(active). ("H" is for non-active.) The default setting of CP2 is a low level. → [7-4. General-purpose I/O pins]

#### ● ON (Auto) Setting

This setting detects the first space bit (start bit) in the string which you wish to send from the converter to the RS-422/485 line, and automatically makes the driver active. The active status of the driver keeps from the last space bit in the string being sent until the internal timer time being set. After that, the driver automatically becomes non-active.

<eg.>9600bps Data 31H SW-A No.1-3 OFF/OFF/ON (1.8ms)

The following chart shows the driver control of the converter.

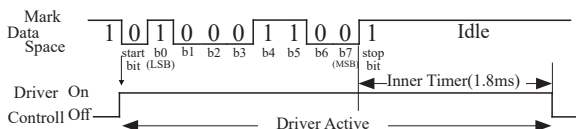

The device is kept active for 1.8ms (internal timer time) after the last space bit. Please do not let the other device respond within 1.8ms.

SW-B	Meaning	OFF	ON
No.1	Select a line mode	RS-422 (full duplex)	RS-485 (half duplex)
No.2	Echo reception of transmission data	With echo back	Without echo back
No.3	Terminal control between SD+ and SD-	Without terminal control	With terminal control(100 ohm)
No.4	Terminal control between SD/RD+ and SD/RD-	Without terminal control	With terminal control(100 ohm)

#### SW-B No1 (Line Mode)

Selects the RS-422/485 line specification which is connected to the converter.

- OFF (Full Duplex) Setting

This setting makes the converter operate in the full duplex RS-422 mode. Communicated data is sent from SD+ and SD- terminals, and is received to SD/RD+ and SD/RD- terminals.

- ON (Half Duplex) Setting

This setting makes the converter operate in the half duplex RS-485 mode. Communicated data is sent and received through SD/RD+ and SD/RD- terminals.

#### SW-B No.2 (Echo Back Setup)

Selects the echo back specification for the half duplex RS-485 mode.

- OFF(Echo Back)

Echo back the data which is sent from the converter to the RS-485 line. The full duplex RS-422 mode does not echo back data even when this switch is in the OFF setting.

- ON(No Echo Back)

When you communicate in the half duplex RS-485 mode, setting this switch to ON prohibits the data, which is sent from the converter to the RS-485 line, is echoed back to the LAN host. Therefore, while the driver is active, the ON setting makes the receiver non-active.

\* Be sure to set this switch to OFF in the full duplex RS-422 mode.

#### SW-B No.3 (Terminal End Between SD+ and SD-)

Setting this switch to ON inserts the terminator 100 ohm between SD+ and SD- (terminal block 1, 2) in a direction of parallel.

#### SW-B No.4 (Terminal End Between SD/RD+ and SD/RD-)

Setting this switch to ON inserts the terminator 100 ohm between SD/RD+ and SD/RD- (terminal block 3, 4) in a direction of parallel.

\*1 Press down the DIP switch to switch on and press up to switch off.

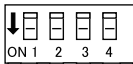

## 2-6. SI-65(A/FA) Cable Connection

### LAN

Connect to the LAN connector of SI-65(A/FA) with a LAN cable of category 5 or more.

→ [3-1. Connect to the LAN network]

### RS-422/485

Connect RS-422/485 terminal block of SI-65(A/FA) and RS-422/485 signal line of the target device by using a twisted pair cable.

#### ● Proper RS-422/485 cable

Size : AWG24-14 / single wire 0.2 - 2.5mm<sup>2</sup> / twisted cable 0.12 - 1.5mm<sup>2</sup>

Wire strip length: 6mm. Please do not make branch wire when using twisted cable.

If using the ferrule terminal, ferrule diameter should be 1.5mm or less.

Following are the recommendation.

Phoenix Contact Inc. "AI0.25-8YE AWG24"

JST Mfg. Co., Ltd. "TUB-05 AWG26-22"

#### RS-422 (full duplex) Setting

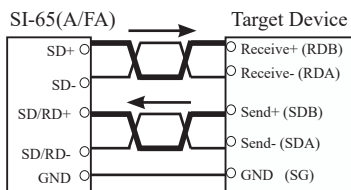

#### RS-485(half duplex) Setting

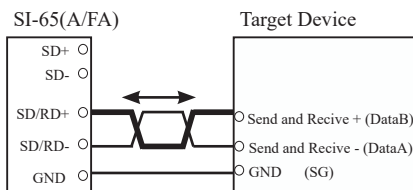

\* ( ) are the examples of RS-422/485 differential signals.

Usually, differential signal [+] uses [B] and differential signal [-] uses [A].

\* Connect the GND(SG) between devices to protect higher voltage runs into the other device.

The following chart shows a connection example to connect the converter to more than two devices in the half duplex mode by N to N.

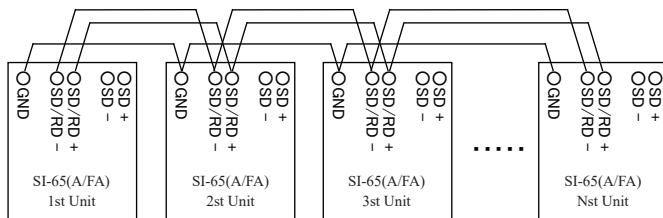

\* This multidrop system can connect up to 128 units.

\* The first unit and the "N" unit need a termination resistor.

## 2-7. SI-65(A) Power Source

There are two ways to supply power to SI-65/SI-65A.

### ■ Supply by AC

1. Connect the plug of the AC adapter to the DC jack (DC-IN) of SI-65/SI-65A.
2. Plug the AC adapter to an AC outlet to supply power.

Please use appropriate AC adapter which complies with the power specification and safety standards of the country in which you use SI-65/SI-65A.

Model	Power specification	Operation Temperature	Safety standards
VFN-650B	AC 100V , 50/60 Hz	-10 ~ 50°C	PSE
6A-181WP09	AC 100 - 240 V, 50/60 Hz	0 ~ 40°C	PSE/UL/CUL/FCC/ CCC/CE

Note: When using VFN-650B (AC adapter), power consumption of AC is about 4.9VA for SI-65 and about 3.8VA for SI-65A.

Input range of AC power is rated voltage  $\pm 10\%$

To supply power from external power supply into the DC-IN connector, use the optional power plug cable (SIH-2PG). For SI-65A, use the external power supply with output voltage of DC 5 to 30V (2W or more) , and for SI-65A, use 5 to 9V (4W or more).

### ■ Supply by terminal block

#### (In the case of SI-65)

1. Prepare DC source of 5 - 12V (DC 5 - 9V is recommended), 4W or more.
  - \* Current consumption of SI-65 is up to 300mA regardless of supply voltage. External source of lower voltage is recommended. Because the more voltage is, the more power consumption and heat tend to be.
2. Connect the 6th pin of the terminal connector with the plus pole of the external source and connect the 5th pin with the minus pole (GND) of the source.
  - \* Please use a cable of AWG22 - 14. Bare the end of the cable for 6mm, which is to be connected to the terminal block. Please do not make offset when you use twisted wire.

#### (In the case of SI-65A)

1. Prepare DC source of 5 - 30V, 2W or more.
  - \* Current consumption of SI-65A is up to 330mA when DC is 5V, 130mA when DC is 12V and 60mA when DC is 30V.
2. Connect the 6th pin of the terminal connector with the plus pole of the external source and connect the 5th pin with the minus pole (GND) of the source.
  - \* Please use a cable of AWG22 - 14. Bare the end of the cable for 6mm, which is to be connected to the terminal block. Please do not make offset when you use twisted wire.

## 2-8. SI-65FA Power Source

---

1. Prepare a power source of AC 85 - 264 V (50/60Hz).
  - \* Current consumption of SI-65FA is up to 40mA when AC is 100V and 24mA when AC is 240V.
2. Please confirm that there is no power supply on the cable, then open the cover of terminal block and connect the cables.
3. Connect the external AC power source to the AC IN of the terminal and the grounding wire to the FG terminal.

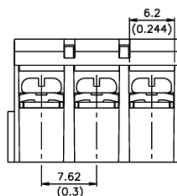

- \* Please use a cable of AWG22 - 14. Width of the screw part of the terminal is 6.2mm. Please do not make offset when you use twisted wire.
- \* Please connect to ground to prevent electric shock and to protect from external surge.

## Chapter 3 Basic Configuration

### 3-1. Connect to the LAN network

Connect LAN connector of converter to the HAB/PC using LAN cable.

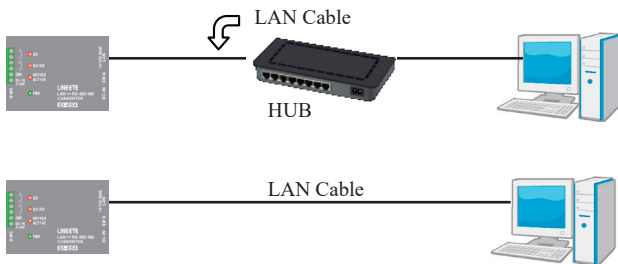

- \* The LAN port on this unit does not have the AutoMDI/MDI-X function. When directly connecting to a device that does not have the AutoMDI/MDI-X function, use a crossover LAN cable.
- \* Try to use a short LAN cable when concerning the noise.

### 3-2. Basic configuration

Configuration can be set from following procedure.

- Set through network using Web browser  
Input the IP address in the Web browser of the PC, and set from the Web manager.  
→ Refer to "Chapter 4".
- Use set-up mode  
Connect the converter by Telnet connection, and then open the set-up mode.  
(For serial connection, input the special command after turning on the power to enter into the set-up mode.  
→ Refer to [Xport User Guide (XPort\_UG.pdf)] in the CD-ROM.

If entering the incorrect IP address, it may affect the whole network. To use it properly, consult with your network manager. Please write down the important configuration in case of resetting.

- IP Address ..... [ . . . ]
- Subnet Mask..... [ . . . ]
- Default Gateway..... [ . . . ]

Above information and password are necessary to reset the device.  
If losing those, the device may need to be repaired.

### 3-3. Default IP address

---

As a factory setting, DHCP client mode and AutoIP function automatically set IP address.

- \* When the IP address is 0.0.0.0 (factory setting), those functions are valid. When IP address is 0.0.1.0, only DHCP client function is valid.

#### When having DHCP server in the network

IP address is automatically set from the DHCP server when turning on the power of device.

#### When not having DHCP server in the network

One of the IP addresses of "169.254.01" to "169.254.255.1" is automatically set by the AutoIP function when turning on the power of device.

➔ Refer to "Chapter 3-4."

### 3-4. Usage of DeviceInstaller

---

Install the DeviceInstaller of Lantronix for setting the IP address.

Preparation: Log to the PC as administrator. If you had already installed the previous version of DeviceInstaller, uninstall it.

- \* If you would like to use the converter with XPort firmware Ver.1.8, used the previous version of DeviceInstaller. The latest XPort firmware is displayed as "Unknown:x5" or "Unknown:x9".

1 Double click on "setup\_di\_x86x64cd\_4.4.0.0.exe" in the "/lantronix/DeviceInstaller/ver4.4.x.x" folder. If you find the latest version in the CD-ROM, use the latest version.

2 Install it following the wizard.

- \* OS for DeviceInstaller(v4.4.x.x): Windows x86: XP/ 2003 Server/ Vista/ 7/ 8/ 2008 Server  
Windows x64: vista/ 7/ 8/ 2008 Server

- \* We have confirmed that both DeviceInstaller (v4.4.0.4) and (v4.4.0.7) work with Windows 11, but Lantronix has not released a note for support for Windows 11 (No official guarantee by Lantronix).

- \* If the PC is connected to the Internet, ".NET Framework" is automatically installed. Refer to the "Release.txt" file in the CD-ROM for information of ".NET Framework" version.

3. Click [No] if following dialog is appeared.

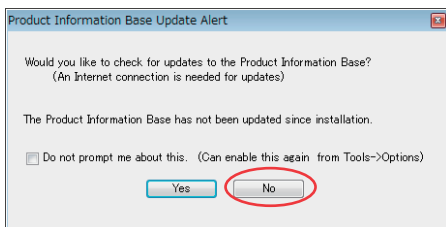

### 3-5. Confirm IP address

---

1. Connect the converter to the network and turn on the power.
2. Open the DeviceInstaller from Start menu.
3. Device embedded with XPort is displayed on the main window.

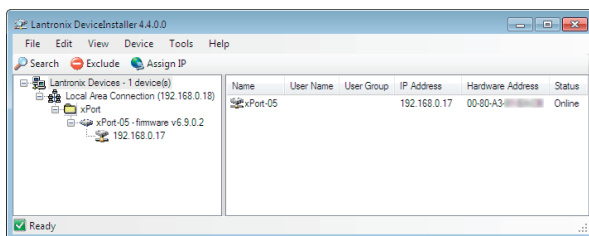

4. Select the one matched with the hardware (MAC) address and confirm the IP address. Hardware (MAC) address is written on the backside of label of the converter.

## 3-6. Assign IP address

1. Click on IP assignment.
2. Select the method and then click [Next].

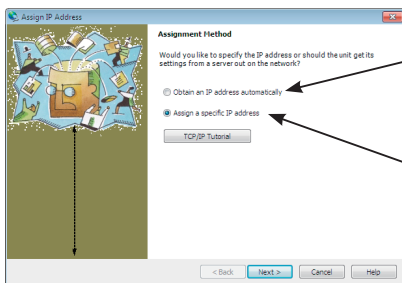

When selecting  
[ Assign a specific IP address ]

3. Input the IP address in the [IP Settings]. Then click [Next].

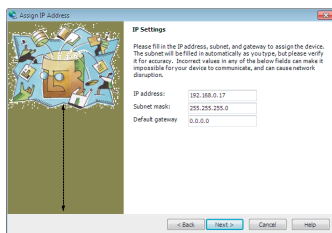

- \* Consult with your network manager.
- \* Recommend not invalidating the [Auto-IP] function.

When selecting  
[ Obtain an IP address automatically ]

3. Select the function to validate in the [IP discover setting] and then click [Next].

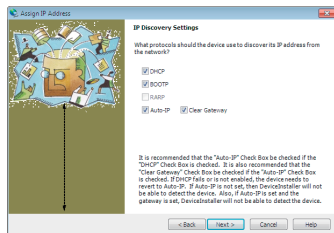

4. Click [Assign] to validate the configuration.

### Note

Do not turn off the power of converter until completing the restart after clicking [Assign]. Writing the wrong configuration on the XPort and cause the malfunction.  
\*Refer to the online help of DeviceInstaller for appropriate use of DeviceInstaller.

IP address can be set using the set-up mode.

➔ Refer to [Xport User Guide (XPort\_UG.pdf)] in the CD-ROM.

IP address can be set using the configuration tool "SILANIOinit".

➔ Refer to [SILANIOinit.txt (instruction)] in the CD-ROM.

# Chapter 4 Configuration Using Web Manager

## 4-1. Web Manager Usage

The configuration can be changed from a Web manager.

➔ For more details refer to [Xport User Guide (XPort\_UG.pdf)] in the CD-ROM.

- Accessing from the deviceinstaller

Select the device being set. Select [Web Configuration] tab and click [  ] icon. Enter the user name and the password, as you will be required. If you have not set your user name and password, enter nothing and click [OK].

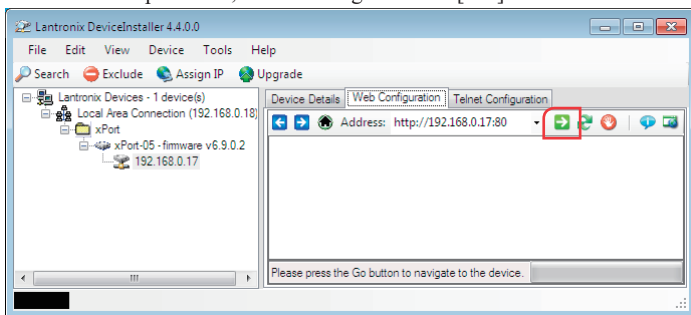

- Accessing from the web browser

Open your web browser and enter the IP address. Then you will be required to enter the user name and the password. If you have not set your user name and password, enter nothing and click [OK].



Input the IP address  
of the device

**Note**

If you cannot change the setting, for Internet Explorer, please check the “Every time I visit the webpage” at “[ Tools ] - [ Internet options ] - [ General ] - [ Browsing history ] - [ Settings ] - [ Temporary Internet Files ] - [ Check for newer versions of stored pages: ]”. If it does not display correctly, please validate “Compatibility View”.

## ● Web Manager Usage

Server setting such as CPU Performance

Serial Communication Conditions setting

LAN Connection setting.

Product Information	
Firmware Version:	V6.9.0.2
Build Date:	07-Feb-2013

Network Settings	
MAC Address:	00-80-A3-...
Network Mode:	Wired
DHCP HostName:	< None >
IP Address:	192.168.0.60
Default Gateway:	0.0.0.0
DNS Server:	0.0.0.0
MTU:	1400

Line settings	
Line 1:	RS232, 230400, 8, None, 1, Hardware.

WebManager Version: 2.0.0.2

Copyright © Lantronix, Inc. 2007-2013. All rights reserved.

After setting the various settings such as [Serial Settings], [Connection] etc., click "OK" button. Then "Done!" will be displayed and the setup contents hold by Web Manager temporarily.

To save and apply the configuration changes to the device server, click the Apply Settings button. (The Apply Settings button makes the changes permanent and reboots the XPort.)

- \* If you change the IP address on the Webmanager and set it by [Apply Setting], state of progress of configuration process will appear repeatedly, because the connection between this device and the PC for configuration cannot be sustained.

In this case, please close the Web manager. Then run the Web manager again with the changed IP address.

### Note

- If the Web Manager settings do not change after clicking "Apply Settings," try clearing the cache of your web browser or changing its settings to clear it. For example, in Microsoft Edge, try holding down "ctrl" and pressing "F5" on your keyboard.
- When using a web browser other than Internet Explorer, if the display layout is distorted or the login screen is not displayed correctly, please enable the "IE compatibility mode" of each web browser.

For detailed setting procedures, please check the operating instructions for your web browser.

## 4-2. Communication conditions of serial port

---

1. When using with baud rate 460800 or above, select "Server" and set High to "CPU Performance Mode". If baud rate is less than 460800, do not need to set it.
2. Select [Serial Settings].  
Set "Protocol" to be "RS-232C" in serial side. Set Baud Rate, Data Bits, Parity, Stop Bits and Flow Control to be same as the target device.

### Note

Set "Protocol" to be "RS-232C".  
Settings other than "RS232" do not support echo back and line monitoring function.  
To use the device for RS-485 (2-lines), set "Flow Control" to be "CTS/RTS (Hardware)".

3. Click [ OK ] and then click [ Apply Settings ].

## 4-3. Set up LAN connection mode

---

### ■ LAN protocol

Select [ Connection ]. Then select TCP or UDP.

You can setup either one of them.

\* If you select UDP protocol, set [ Datagram Type ] to [ 01 ].  
Change [ Remote Host ] and [ Remote Port ] if necessary.

### ■ Server Mode

If you select TCP protocol set [ Accept Incoming ].

Select Yes to accept incoming connections. (Server mode)

### ■ Client Mode

If you select TCP protocol set [ Active Connect ].

Set client mode to send a request of TCP connection to other device.

## 4-4. Other Setting

---

You can set various settings according to your usage.

➔ For more details refer to [ XPort User Guide (XPort\_UG.pdf) ] in the CD-ROM.

### ■ Pack Control

The packing algorithms define how and when packets are sent to the network.

Select [ Channel 1 ] --> [ Serial Settings ] and check [ Pack Control ]--> [ Enable Packing ] to control the received data as you define.

e.g.)

Packets are sent to the network, when no serial data is received for 12 msec or received 2bytes of CRC data after received 0x03

Idle Gap Time	: 12msec
Match 2 Byte Sequence	: No
Match Bytes	: 0x03,0x00
Send Frame Immediate	: No
Send Trailing Bytes	: Two

If the packet size reaches to the Maximum Transmission Unit (MTU) (default 1400 bytes), a transmission might occur even if the packets are not satisfy the condition.

### ■ Disconnect TCP

Select [ Channel 1 ] --> [ Connection ] and set [ Disconnect Mode ] to setup the condition of disconnect TCP by the serial non-communication time.

e.g.)

Disconnect TCP when more than 30 sec of non-communication time.

On Mdm_Ctrl_InDrop	: No
Check EOT(Ctrl-D)	: No
Hard Disconnect	: Yes
Inactivity Timeout	: 0:30(mins:secs)

### ■ TCP Keepalive

Select [ Server ]. Set [ TCP Keepalive (secs) ] 1 to 65(sec).

No TCP keepalive packet will be send, if you set 0.

Check the connection status by sending the TCP packet for checking.

### ■ Restore default XPort settings

Select [ Apply Defaults ] of Main menu to initial (factory default) all setup, except network address (such as IP address etc.) and I/O pin.

➔ [7-5. Factory setting]

# Chapter 5 Setup Example

## 5-1. Server mode usage

To use Device A (connected with the serial port of converter) through network connection by TCP connection request from a device on the network such as PC to the converter, please refer following setting.

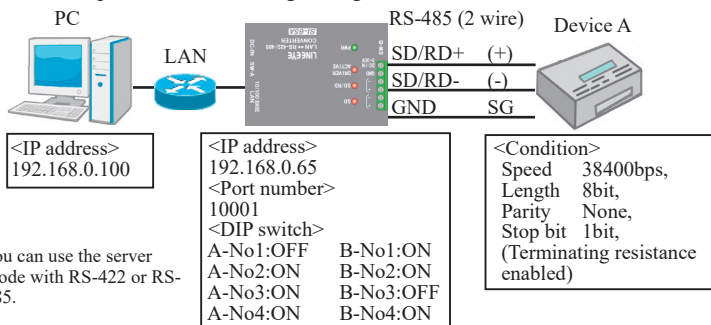

### Example of DeviceInstaller Setting

IP Address:	192.168.0.65
Subnet Mask:	255.255.255.0
Default Gateway:	0.0.0.0

Set a specific IP address.

\* Assign by the proper method, concerning the usage and environments, and consulting with your network manager.

### Example of Web Manager Setting

#### Serial port Condition

Select Serial Settings at the menu and set the communication condition.  
Press OK after setting the values.

<b>Port Settings</b>	
Protocol: RS232	Flow Control: None
Baud Rate: 38400	Data Bits: 8
Parity: None	Stop Bits: 1

#### LAN connection mode (Server mode: valid, Client mode: invalid)

Select Connection at the menu and set "YES" at Accept Incoming.  
Press OK after setting the value.

<b>Connect Mode</b>	
<b>Passive Connection:</b>	<b>Active Connection:</b>
Accept Incoming: Yes	Active Connect: None

Press "Apply Settings" at the menu after setting all the values which you want to set.

## 5-2. Client Mode Usage

To use the serial port of the Device B through network connection by TCP connection request from the converter to a server on the network when the converter has received a serial data of Device B, please refer following setting.

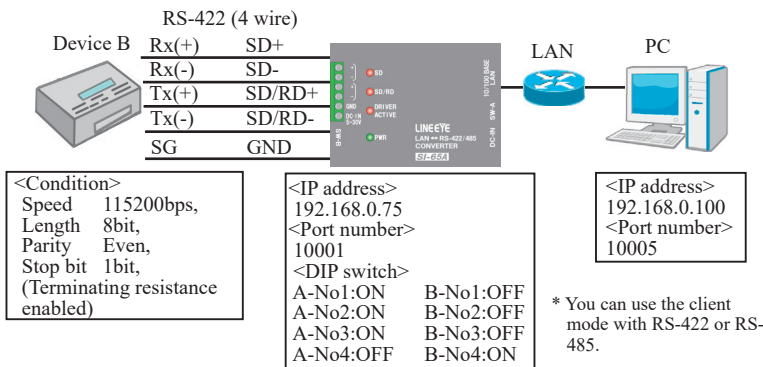

### Example of DeviceInstaller Setting

IP Address:	192.168.0.75
Subnet Mask:	255.255.255.0
Default Gateway:	0.0.0.0

Set a specific IP address.

\* Assign by the proper method, concerning the usage and environments, and consulting with your network manager.

### Example of Web Manager Setting

#### CPU performance settings

Select "Server" at the menu and then select "High" when you use at 460.8Kbps of communication speed or faster. Press OK after setting the value.

CPU Performance Mode:  Low  Regular  High

#### Serial port Condition

Select Serial Settings at the menu and set the communication condition. Press OK after setting the values.

<b>Port Settings</b>	
Protocol: RS232	Flow Control: None
Baud Rate: 115200	Data Bits: 8
Parity: Even	Stop Bits: 1

#### LAN connection mode (Server mode: invalid, Client mode: valid)

Select "Connection" at the menu and select "With Any Character" at Active Connect. Then set the IP address of the PC to "Remote Host" and Port number of the PC to "Remote Port". Press OK after setting the values.

<b>Passive Connection:</b>		<b>Active Connection:</b>	
Accept Incoming: No		Active Connect: With Any Character	
<b>Endpoint Configuration:</b>			
Local Port: 10001		<input type="checkbox"/> Auto increment for active connect	
Remote Port: 10005		Remote Host: 192.168.0.100	

Press "Apply Settings" at the menu after setting all the values which you want to set.

## 5-3. Using two units of converter

To extend serial communication between Device A and Device B through network by using two units of converters, please refer following setting.

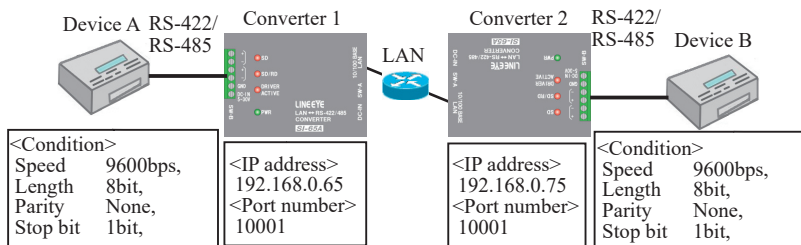

\* Set the dip switches depending on the RS-485/RS-422 specification of the devices which connect to Converter 1 and 2. (2-5. SI-65(A/FA) hardware setup)

### Example of DeviceInstaller Setting

Set a specific IP address to the converter 1.

#### Converter 1

IP Address:	192.168.0.65
Subnet Mask:	255.255.255.0
Default Gateway:	0.0.0.0

\* Assign by the proper method, concerning the usage and environments, and consulting with your network manager.

Set a specific IP address to the converter 2.

#### Converter 2

IP Address:	192.168.0.75
Subnet Mask:	255.255.255.0
Default Gateway:	0.0.0.0

\* Assign by the proper method, concerning the usage and environments, and consulting with your network manager.

### Example of Web Manager Setting

#### SerialPort Condition

On Converter 1, select “Serial Settings” at the menu and set the communication condition. Press OK after setting the values.

#### Converter 1

Port Settings					
Protocol:	RS232	Flow Control:	None		
Baud Rate:	9600	Data Bits:	8	Parity:	None
				Stop Bits:	1

On Converter 1, select “Serial Settings” at the menu and set the communication condition. Press OK after setting the values.

#### Converter 2

Port Settings					
Protocol:	RS232	Flow Control:	None		
Baud Rate:	9600	Data Bits:	8	Parity:	None
				Stop Bits:	1

## LAN Connection Mode (Server Mode: Enable, Client Mode: Enable)

On converter 1, select “Connection” at the menu and select “With Any Character” at Active Connect. Then set the IP address of the converter 2 to “Remote Host” and port number of the converter 2 to “Remote Port”. Press OK after setting the values.

### Converter 1

<b>Connect Mode</b>	
<b>Passive Connection:</b>	<b>Active Connection:</b>
Accept Incoming: Yes	Active Connect: With Any Character
<b>Endpoint Configuration:</b>	
Local Port: 10001	<input type="checkbox"/> Auto increment for active connect
Remote Port: 10001	Remote Host: 192.168.0.75

On converter 2, select “Connection” at the menu and select “With Any Character” at Active Connect. Then set the IP address of the converter 1 to “Remote Host” and port number of the converter 1 to “Remote Port”. Press OK after setting the values.

### Converter 2

<b>Connect Mode</b>	
<b>Passive Connection:</b>	<b>Active Connection:</b>
Accept Incoming: Yes	Active Connect: With Any Character
<b>Endpoint Configuration:</b>	
Local Port: 10001	<input type="checkbox"/> Auto increment for active connect
Remote Port: 10001	Remote Host: 192.168.0.65

Press Apply Settings at the menu after finishing all the settings of converter 1 and 2.

Because "Active Connect" of both converter 1 and converter 2 are configured as "With Any Character", when a serial port of converter 1 or 2 receives data, the device which received the data will connect with the other device by TCP and send the data through the network.

# Chapter 6 COM Port Redirector

---

## 6-1. About Virtual COM Port

---

The COM Port Redirector is the utility software to get the serial communication application not supporting the network connection to be able to use on the network. The redirector creates the virtual COM ports in Windows. Communications for these virtual COM ports are transferred to the serial port on the converter through the network.

### Note

- The COM Port Redirector works at most of the application software. However, some applications, which have a limit to receive/transmit data, may not work well. In this case, change the timeout of communication longer or change the setting to support socket communications.
- The operating environment for CRR Ver. 4.3.x.x published by Lantronix is Windows 7/8 and Server 2008. It can also be run on Windows 11, but an error occurs when adding two or more COM ports, and special measures are required. For solutions, please refer to the FAQ on our website.
- The COM Port Redirector cannot be used with other software, which creates the virtual COM port. Be sure not to install the COM Port Redirector to PCs, which have already installed such software.

## 6-2. Basic Setting

---

Depending on the target devices, setup of the serial port and virtual COM port condition is required to change.

➔ [4-2. Communication conditions of serial port]

Assign a specific IP Address. (recomendation)

➔ [Chapter 3 Basic Configuration]

## 6-3. Install COM Port Redirector

---

Install ComPortRedirector (CPR) to your PC.

\* If you already have previous version of COM Port Redirector, please uninstall it.

Login to the PC as administrator.

1. Execute the setup file [Ver4.3.x.x] in the ComPortRedirector. Select the folder which matches your version.
2. To install, follow the installation wizard instructions.
3. Restart the PC.

NOTE Environment for the usage of supported OS differs depending on the version of the ComPortRedirector attached to the product. For further detail, please refer Release.txt in the folder of the name of the version (\lantronix\ComPortRedirector) in the CD-ROM.

## 6-3. Install COM Port Redirector

---

Install ComPortRedirector (CPR) to your PC.

\* If you already have previous version of COM Port Redirector, please uninstall it.

Login to the PC as administrator.

1. Execute the setup file [Ver4.3.x.x] in the ComPortRedirector. Select the folder which matches your version.
2. To install, follow the installation wizard instructions.
3. Restart the PC.

**NOTE** Environment for the usage of supported OS differs depending on the version of the ComPortRedirector attached to the product. For further detail, please refer Release.txt in the folder of the name of the version (\lantronix\ComPortRedirector) in the CD-ROM.

## 6-4. COM Port Redirector

---

Connect the converter to the network.

Login to the PC as administrator.

1. From start menu, go to "Lantronix" -> "CPR 4.x" -> "CPR Manager. "CPR Manager" window will be displayed.

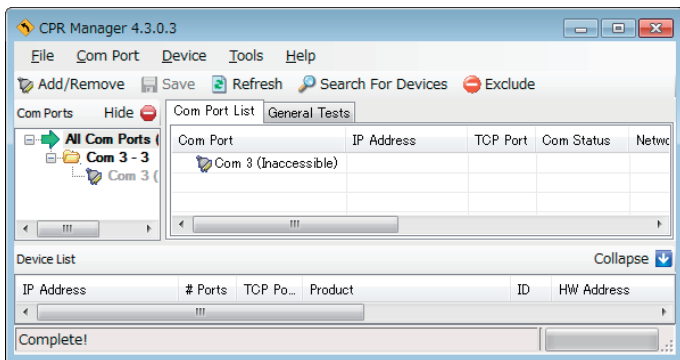

2. Click [Com Port]-[Add and Remove] of toolbar to open the dialog to register/delete the virtual COM port. Select the COM number and click [OK].
  3. In the dialog box, check the COM port you wish to use as the virtual COM port.
  4. In the [ Settings ] tab, there is a host list table. Set the IP address and port number at [ Host ] and [ TCP Port ] in the [ Service1 ]. Click [ Search For Devices ] icon and double clicking the XPort product on the "Device list" to reflect it in the host list table.
  5. Click "Save" icon or go to [Com Port] -> [Save Settings] to save the configurations. If your computer shows a dialog of hardware installation, ignore it and click [Next].
- ➔ For more details refer to [Xport User Guide (XPort\_UG.pdf)] in the CD-ROM.

# Chapter 7 Documents

## 7-1. Option

Name	Model	Remarks
Wide input AC adapter	3A-183WP09	For SI-65/SI-65A Input AC100 to 240V, 50/60Hz
Power plug cable	SIH-2PG	For DC-IN of SI-65/SI-65A
RS-422 cable	SI-C422-TT5-5	Rod-like terminal, 4 cores + 1, 5m
RS-485 cable	SI-C485-VT3-5	Rod-like terminal - Ring terminal, 2 cores + 1, 5m
LAN cable	SI-C5EL-S3	Category 5e, 3m
Wall bracket	SI-WM1	For SI-65/SI-65A
L bracket	SI-ML1	For SI-65FA
DIN plate	SI-DIN70	For SI-65/SI-65A For installation to 35mm DIN rail
DIN plate	SI-DIN10	For SI-65FA For installation to 35mm DIN rail
DIN vertical plate	SI-DIN30S	For SI-65 / SI-65A For vertical installation to 35mm DIN rail
Magnet	SI-MG70	For SI-65/SI-65A

For more details about optional goods, please contact LINEEYE distributors or LINEEYE.

## 7-2. Ordering information

Name	Model	Description
Interface Converter SI-65	SI-65	Japanese model <sup>*1</sup>
	SI-65-E	Overseas model <sup>*2</sup>
	SI-65-NS	Converter and warranty only <sup>*3</sup>
Interface Converter SI-65A	SI-65A	Japanese model <sup>*1</sup>
	SI-65A-L	Wall-mount model
	SI-65A-E	Overseas model <sup>*2</sup>
	SI-65A-NS	Converter and warranty only <sup>*3</sup>
Interface Converter SI-65FA	SI-65FA	Standard model
	SI-65FA-L	Wall-mount model

\*1: The Japanese model is provided with utility CD, manual, warranty, and AC adapter (VFN-650B) with an input of 100VAC.

\*2: The overseas model is provided with utility CD, manual, warranty, and AC adapter (3A-183WP09) with an input range of 100 to 240VAC. English manual is in utility CD as PDF format.

\*3: This model is for customers who purchase several units. Utility CD, manual and AC adapter are not provided. Configuration tools stored in the utility CD are available from web page.

## 7-3. LAN Connector Specification

---

### LAN Connector Pin Assignment

Pin No.	Name	I/O Direction *1	Description
1	TX+	Out	Transmission Data +
2	TX-	Out	Transmission Data -
3	RX+	In	Reception Data +
4	-	-	Not Used
5	-	-	Not Used
6	RX-	In	Reception Data -
7	-	-	Not Used
8	-	-	Not Used

\*1 "Out" means a direction to output signals from the converter. "In" means a direction to input signals to the converter.

### LAN Connector LED Display

Left LED	Right LED	Meaning
OFF		Does not connect Ethernet.
Solid Amber		Connected 10 BASE-T.
Solid Green		Connected 100 BASE-TX.
	OFF	Idle
	Blinking Amber	Communicating in the half-duplex mode. (Lights only when communicating.)
	Blinking Green	Communicating in the full-duplex mode. (Lights only when communicating.)

## 7-4. General-purpose I/O pins

---

To read the input status of CP2 on the general purpos I/O pin, send TCP/IP or UDP/IP command to the port number 30704.

### CP2 (RS-422/485 driver) control command of SI-65(A/FA)

"xxh" in the sixth byte of command specifies the output status. "xxh" in the second byte of response shows the result.

Command : 1Bh 02h 00h 00h 00h xxh 00h 00h 00h 00h (9byte)

Response : 1Bh xxh 00h 00h 00h (5byte)

\* "xxh" bit 1 = 0 : Specify RS-422/485 driver is active as factory setting.

\* "xxh" bit 1 = 1 : Specify RS-422/485 driver is non active.

## 7-5. Factory setting

---

### RS-232C Condition

Protocol: RS-232 (Do not change)

Speed: 9600bps, 8bit, Parity: None, Stop 1bit, Flow Control: None

### LAN Action Mode

Accept Incoming: Yes (Server Mode: Enable)

Active Connect: None (Client Mode: Disable)

Local port (Port number): 10001

IP Address 0.0.0.0 (DHCP Client Function and AutoIP Function: Enable)

### Telnet password:

(Password: Disable)

Configuration pins (general purpose IO pin) ➔ [Chapter 1-2.]

Pin	Definition	Active Level
CP1	HW Flow Control Out	High
CP2	General Purpose I/O Input	High
CP3	HW Flow Control In	High

\*Do not change the setting of CP2 and Active Level.

Other initial settings are same on the factory default of XPort. For more details, refer to [Xport User Guide (XPort\_UG.pdf)] in the CD-ROM.

## 7-6. How to apply the factory setting

To apply the factory setting, download the configuration file from the utility CD ([ /LINEEYE/SetupRecord ]). Apply the downloaded file when selecting the setup record file.

SI-65/SI-65A/SI-65A-L/SI-65FA/SI-65FA-L
SI_65_V6902_XXXXX.rec

Use deviceInstaller or [ SILANIOinit ] (configuration tool) to apply the factory settings into the converter.

\* Depending on the versions of XPort or DeviceInstaller, the Configurable Pins or the IP address may not change. This method cannot reset the password.

### Operation of [ SILANIOinit ](configuration tool)

1. Copy "SILANIOinit.exe" from the "/LINEEYE/SILANIOinit" folder in the utility CD to the appropriate folder (For example, "c:/data/").
2. Set your device in the same network segment as your PC.
3. To execute the program, double click on "SILANIOinit" and click "search" to display all XPort embedded

Select your target device.

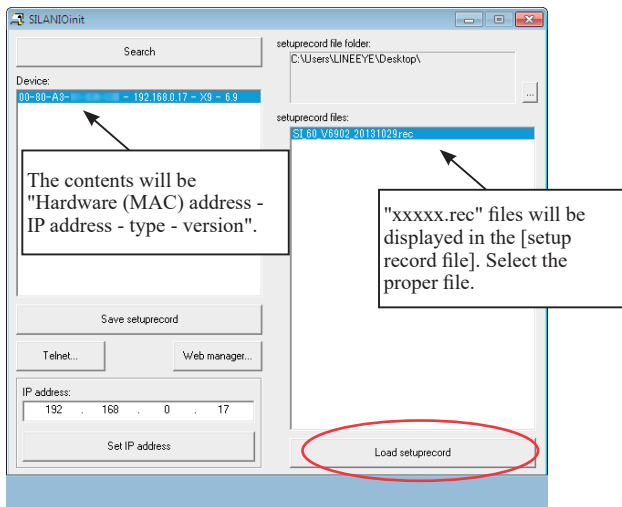

4. Click [save setup record] and the configuration will be saved.  
➔ To use this application, refer to the "SILANIOinit.txt" in the CD-ROM.

### Operation of DeviceInstaller

1. Install DeviceInstaller to your PC and download the configuration file from the utility CD to the appropriate folder (For example, "c:/setup/").  
➔ [3-4. Usage of DeviceInstaller]
2. Set your device in the same network segment as your PC.(If your devices are not in the same network segment, you may not be able to set.)
3. Start DeviceInstaller and click [Search] to display all XPort embedded devices. Select your target device.
4. Click upgrade icon or go to [Device] ➔[Upgrade].
5. [Device upgrade wizard –step 1/5] will appear. Select [Custom install] and click [Next].
6. [Device upgrade wizard –step 2/5] will appear. Click [Next].
7. [Device upgrade wizard –step 3/5] will appear. Select [Install setup records from a file] and click [Browse].
8. Open the configuration file in the appropriate folder (For example, "c:/setup/") . Click [Next].
9. [Device upgrade wizard –step 4/5] will appear. Click [Next]. Start the writing of configuration files to the target device.
10. [Device upgrade wizard –step 5/5] will appear. "installation has finished" will be displayed. Close the window.  
➔ For more details refer to [ DeviceInstaller User's Guide (\lantronix\Docs\DeviceInstaller\_UG.pdf) ] in the CD-ROM.

\* Network address such as IP Address etc. would not be changed if you use DeviceInstaller to set Setup Record.

#### Note

Please note that if you write inappropriate configuration file (e.g. configuration file for different models or different versions of the firmware), the XPort may not run correctly and will need to be repaired.

## 7-7. Installation Method

### ■ Set in the stable place

Rubber feet are put on the bottom of the device. Please set it on a flat and stable place.

- \* Please place it as far away from high voltage equipments or power equipments as possible.

### ■ Using screws

There are four M3 screw holes on the back of converter.

#### Note

Use M3 screw, which can be inserted into the converter less than 7mm depth from the top of the case. If the depth is deeper than that, it will damage the main circuit.

Screw holes on backside (SI-65/SI-65A)

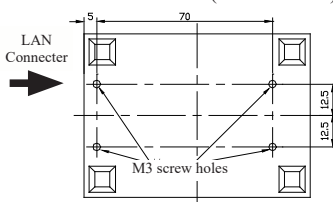

L bracket (SI-ML1)

For SI-65FA, it is possible to screw from the front of the device after inserting the L bracket on the side. (Does not support SI-65FA-L)

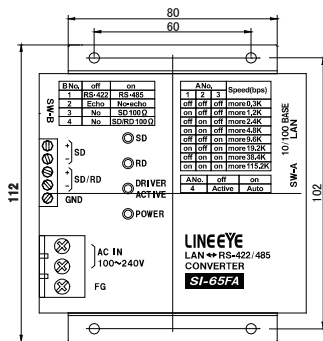

Optional L bracket (SI-ML1) fitting condition

### ■ DIN rail

You can attach it to a 35mm DIN rail by using SI-DIN70 (optional) for SI-65/SI-65A or SI-DIN10 (optional) for SI-65FA. (SI-65FA-L does not support attachment to din rail.)

1. For SI-65/SI-65A, screw DIN rail mounting plate (SI-DIN70) to M3 screw halls on the bottom of the product.  
For SI-65FA, screw DIN rail mounting plate (SI-DIN10) to M3 screw halls on the side of the product.
2. Insert it by pushing it into the DIN rail from the front side of the rail.
3. To remove the plate from the DIN rail, pull up the knob using the screwdriver etc.

DIN rail mounting plate (SI-DIN70)

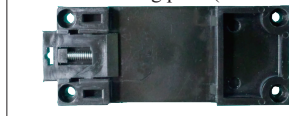

■ Usage of Wall bracket (SI-WM1) (For SI-65/SI-65A)

With a wall bracket (SI-WM1, optional), you can fix the converter to a wall by screwing from the upper side of the bracket or hooking it to screws or nails hammered into the wall.

Wall bracket (SI-WM1)

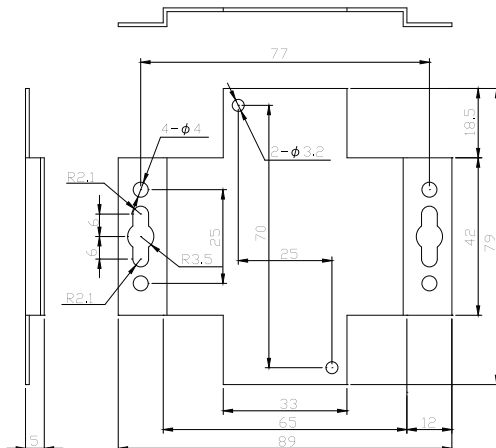

\* Two  $\phi 3.2$  holes are for attaching this bracket on the backside of the converter, other holes on each side of the bracket are for attaching on the wall.

■ To attach to the wall (SI-65A-L)

SI-65A-L can be hung on the wall by screwing from upper side.  
SI-65A-L does not support L Bracket nor DIN plate.

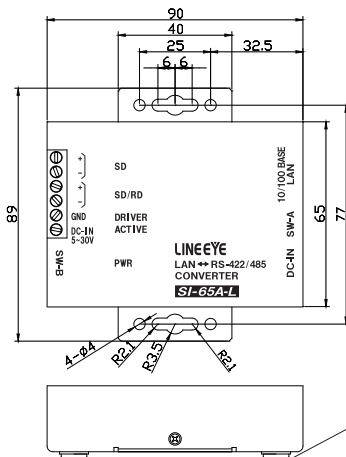

Rubbers can be removed.

■ Attach on the wall (For SI-65FA-L)

SI-65FA-L can be hung on a wall by screwing from the top side.

Note: SI-65FA-L does not support L bracket and DIN rail mounting plate.

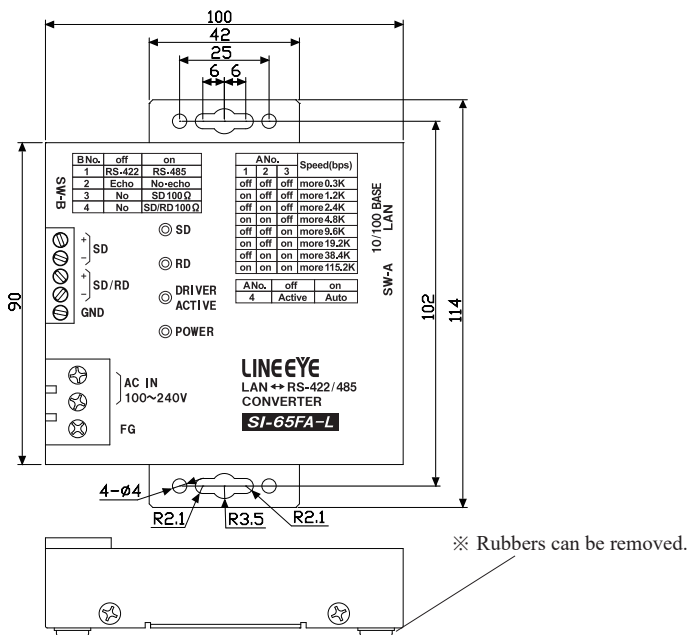

## 7-8. Transmission distance of RS-422/485

### <Transfer Distance>

The faster communication speed is, the shorter the transfer distance for RS-422/485 is. See the right table and set communication speed following the actual distance.

Also, the maximum of the actual communication speed changes depending on conditions: environments like noise, cable features used, etc. For actual use, be sure to conduct a communication test to check.

Distance (m)	Speed (bps)
100	to 920k
200	to 230.4k
600	to 115.2k
1200	to 57.6k
2400	to 9,600

## Chapter 8 Warranty and After-Sales Service

---

### 8-1. Troubleshooting

---

The "PWR" LED does not light.

< When using the AC adapter > Is the AC adapter connected correctly?	Check that you plug the AC adapter into the AC adapter plug or wall outlet correctly. Check the voltage of AC adapter.
< When powering from terminal block > Is the terminal block connected correctly?	Check that you connect the terminal block correctly. Check the voltage of DC power.

Neither the left and right LEDs for the LAN connector do not light or blink.

Is the LAN cable connected correctly?	Check that the connector is connected correctly, or that the cable breaks, etc.
Is the link LED on the switching hub lighting?	Try to connect with other port of hub.
Connect two units or to a PC using LAN cable?	Use the cross-over LAN cable

Cannot find in the Deviceinstaller

Is the converter connected to the same network segment with PC?	Can not search, if the converter connected to the different network segment.
Is IP address of the converter duplicated with other equipment ?	If the IP address of the converter duplicated with other equipment, take off the LAN cable immediately and change the IP address. ➔ For more details refer to [Xport User Guide (XPort_UG.pdf)] in the CD-ROM.
Does the security software on the PC interrupt communications?	Check the settings in your OS or security software.

Accessing from the Web browser cannot start the Web manager.

Do you correctly assign IP Address?	Check the IP address on the converter.
Do routers, firewall or others on the network interrupt communications?	Contact your network administrator to check.

Set from the web browser but cannot reflect when opening it again.

Check the setting of IE.	➔ Refer the Note of [4-1. Web Manager Usage]
--------------------------	--

Cannot connect the converter from the network.

Is the IP address and port number set correctly?	Search the device by using the device installer and check the network address again.
Is the converter connected to the other network segment beyond the router?	Assign IP Address of router to default gateway of the converter. Also condition of router firewall may need to be changed, contact your network administrator to check.
Are you using COMPortRedirector?	Please confirm if the COMPort No. which is set on the COMPortRedirector is used on the side of the application software.
Is the connection mode set to Server Mode?	Check the condition of converter.

Cannot communicate on the RS-422/RS-485 port side

Are SD/RD LEDs blinking?	It is working correctly if the LEDs are blinking when the data was transmitted on the RS-422/485 line. Note: This can be difficult to distinguish when the transmitted data is too small.
Is the terminal block connected correctly?	Check that the terminal block is connected correctly, that the cables are disconnected, that the cables connected to the wrong connectors, and so on.
Is the DIP switch set correctly?	Set the DIP switch correctly following the connection method, communication conditions, etc.
Are the GND terminal on the converter and the signal grand on the target device, connected?	Connect the GND terminal on the converter to the signal grand on the target device.
Is the communication condition set correctly?	Set to the same values the communication speed, data bits, parity, stop bits, flow control, etc. on both the converter and target device.

## 8-2. Warranty and Repair

---

### Warranty

Within a period of 12 months from the date of shipment, LINEEYE warrants that your purchased products (excepting consumable parts such as the batteries and software) are free of charge from any defects in material and workmanship, only when the products are operated in accordance with procedures described in the documents supplied by LINEEYE. If the defects exist during the Warranty period, please send back the products to LINEEYE distributors or LINEEYE office. LINEEYE will repair or exchange them at no charge. In this case, the shipping charge will be at your own expense.

- The foregoing warranties are the sole warranties given by LINEEYE. Above warranties shall not be applied to the products that have been modified, repaired or altered (excepting by LINEEYE employees) or that have been subjected to unusual physical or electrical stress, misuses, abuse, negligence or accidents.  
LINEEYE disclaims all other warranties including the warranties of merchantability, fitness for some particular purposes and noninfringement of third party right. LINEEYE cannot promise that the software is error-free or will operate without any interruption. When you have some errors while operating the software, please refer to the contents and modified programs shown on our web page (<http://www.lineeye.com>). Please download it from there.

### Repair

LINEEYE will repair the products at your own expense.

For malfunction, please contact the LINEEYE distributors where you purchased at. Or, contact us directly.

If your product needs to be repaired, please read details about a repair on our web page and ask for a repair.

## 8-3. After-Sales Service

---

Our web site contains information about this product.

User registration is required to receive appropriate after-sales support.

Please register as a user using the user registration form on our website.

<https://www.lineeye.co.jp/html/support.html>

There is a registration page on our web site.  
( <https://www.lineeye.com> )  
Please register your product for further support. We  
will provide you the firmware update information  
and sales information etc.

# LINEEYE CO., LTD.

4F., Marufuku Bldg., 39-1, Karahasi, Nishihiragaki-cho, Minami-ku, Kyoto, 601-8468, Japan  
TEL: 075-693-0161 FAX: 075-693-0163

URL: <https://www.lineeye.com>  
Email: [info@lineeye.co.jp](mailto:info@lineeye.co.jp)

Printed in Japan

M-D565AFAE/SI