

LE-3500XR(V2)

LE-2500XR(V2)

Quick Start Guide

Thank you for your purchase of LE-series.

This booklet tells you only the basic operation. For more detailed information, please refer to the instruction manual (PDF) in the utility CD attached to the product.

When you unpack the product, confirm following items

- | | |
|---|---|
| <input type="checkbox"/> Protocol Analyzer | 1 |
| <input type="checkbox"/> Interface Sub-board (attached to the analyzer) | 1 |
| <input type="checkbox"/> DSUB 25pin Monitor Cable (Model: LE-25M1) | 1 |
| <input type="checkbox"/> DSUB 9pin Monitor cable (Model: LE-009M2) | 1 |
| <input type="checkbox"/> DSUB 25-9 conversion adapter | 1 |
| <input type="checkbox"/> 5wire TTL probe (Model: LE-5LS) | 1 |
| <input type="checkbox"/> USB 2.0 Cable(Type A-C) | 1 |
| <input type="checkbox"/> Carrying Bag (Model: LEB-01) | 1 |
| <input type="checkbox"/> USB Battery Charger (Model: LE-P2USB) | 1 |
| <input type="checkbox"/> Utility CD | 1 |
| <input type="checkbox"/> Quick Start Guide (this booklet) | 1 |
| <input type="checkbox"/> Warranty | 1 |

Please let us know if you find any damage to the product or accessories lacking.

USER LIMITATION

This product has been developed for the purpose of using as an analyzer only.

This product has not been developed for the use that needs exclusively high reliability and safety:

aerospace apparatus, trunk communication apparatus, nuclear control apparatus, medical apparatus related with life maintenance etc. Therefore, do not use for those purposes.

This product has Wi-Fi function (IEEE 802.11b/g/n) and emits radio wave. Please do not use near a medical device, microwave, high-level electronics, TV, radio, wireless station for mobile communications, or specified low power radio station.

Where an administrator limits the use of radio devices, follow the instruction of the administrator.

Note : The Wi-Fi module used for this product conforms to SRRC(China), FCC(USA), CE(EU), TELEC(Japan), KCC(Korea), ISED(Canada), NCC(Republic of China), however, this product with Wi-Fi function is allowed to use in Japan, USA, Canada, and EU nations (RE directive, 2014/53/EU).

The Wi-Fi function of this product is set to be invalid depending on the country where it is shipped. Please contact the sales department for details.

Representation of the Operating Procedure

- Key operation is described in [].
- Continuous key operation is described as follows.
ex) Press [MENU] and then [0] → [MENU],[0].
- Screen display is described in “ ”.
- Reference page is displayed in (Pxxx).
- LE-3500XR(V2) and LE-2500(V2) are written as LE-3500XR and LE-2500XR.

It is prohibited to reprint or duplicate any part of this manual without prior permission of LINEEYE.

The content of this manual and specification of the product is subject to change without any notice.

Safety Information

Please do not use the analyzer in the following conditions.

[Description of the symbol and mark]



There is a possibility of getting hurt, such as a death or a serious injury.



There is a possibility of getting injured or damaging the product.

Warning

- * Do not disassemble, modify or repair the analyzer.
This may result in an injury, electric shock, and ignition.
- * Turn off the power and unplug the analyzer immediately when emanating smoke or odor.
Continuous use may result in an electric shock, burn and ignition..
- * Do not use the analyzer if there is inflammable gas.
This may result in ignition and explosion.
- * Turn off the power and unplug the analyzer immediately when liquid or foreign substance gets into the analyzer.
Continuous use may result in ignition, electric shock and malfunction.
- * Do not touch the analyzer with wet hand.
This may result in an electric shock and malfunction.
- * Do not use the batteries other than the Lithium-Ion batteries specified by LINEEYE.

Do not short the electrode of battery, disassemble or modify.
This may result in generation of explosion and ignition.

Caution

- * Do not give a strong impact to the analyzer.
- * Do not place the analyzer in following conditions.
 - Not flat or vibrated place.
 - Temperature or humidity is above the specification.
 - Change the temperature rapidly. • Have a direct sun or near the fire.
 - Magnetic field. Have static electricity.
- * Do not use the analyzer near the following devices.
 - Medical device, such as a heart pacemaker.
 - Automatic control devices easily affected by radio waves.
 - Devices controlled by the radio waves.

Panel Description

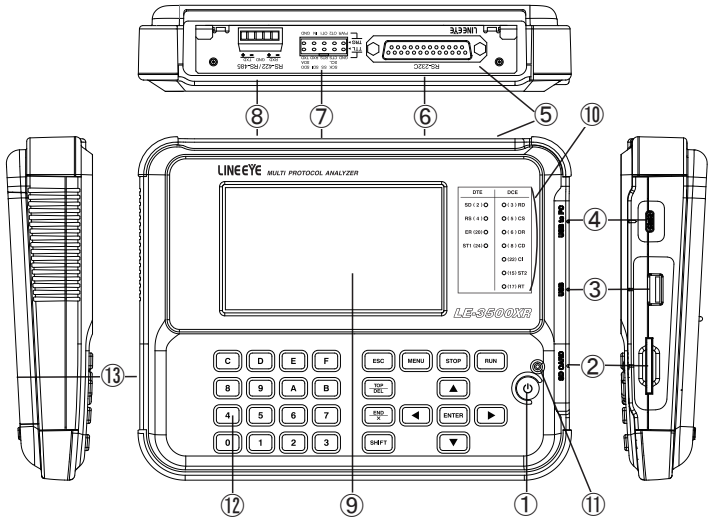

Name		Description
①	Power Switch	Turning the power on/off.
②	SD Card Slot	The inlet for a SD/SDHC card.
③	USB Host Port	Connection port for a USB flash drive.
④	USB Device Port	USB Type-C connector connected to a PC or battery charger.
⑤	Interface Sub-Board	An exchangeable interface sub-board.
⑥	RS-232C Port	A measurement port for RS-232C (V.24).
⑦	TTL, External Signal I/O port	Measurement port for TTL. An I/O port for external signal. It can also be used as a connection port for an optional analog pod.
⑧	RS-422/485 Port	Measurement port for RS-422/485.
⑨	4.3 Inch Color Display	Capacitive touch panel.
⑩	Line State LED	Indicating the logical status of signal lines on the target interface.
⑪	Power LED	Lighting in green when using. Blinking in red when charging battery.
⑫	Keypad	Entering commands and other operation.
⑬	Battery Cover	Open/close when replacing the battery.

Power Supply and Battery

This analyzer drives by the battery or bus power from a USB port.

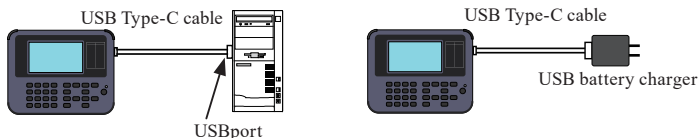

■ Charge the Battery

Lithium ion battery is charged while running it by the USB bus power.

Charging time

When turning off the power: Take about 5 hours for full charge.

When turning on the power: Take several hours for full charge.

→ Change the charging type from the system menu.

- Charge the battery under the condition of 5 °C to 40 °C. If the temperature is below 5, it cannot charge the battery.
- Charge the battery full if you are not going to use it for a long term.

■ Replace the Battery

If the analyzer can no longer drive by the battery, or the service time after charging becomes extremely short, replace the battery.

Remove the battery cover and replace the battery.

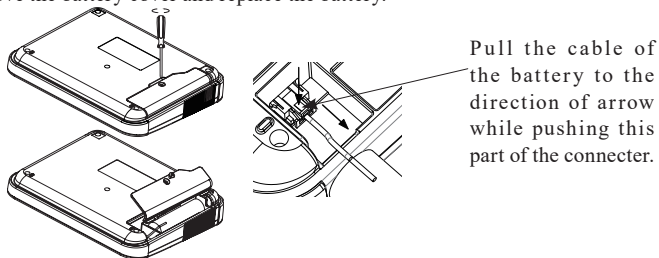

- Battery is necessary for saving data in the storage (USB flash drive etc) when having the power shortage. Insert the battery all the time.

⚠ Warning < Notice for battery >

- * Do not short the terminal of the battery.
- * Use the battery and battery charger specified by LINEEYE.
- * Do not disassemble or modify the battery.
- * Do not use the analyzer near the heater or leave it in the place with high temperature.

It can cause heat, fire, explosion, electric shock, liquid spill and malfunction.

Touch Panel and Keys

Touch panels enable to select settings by soft touch or to scroll displays by swipe.

■ Keys

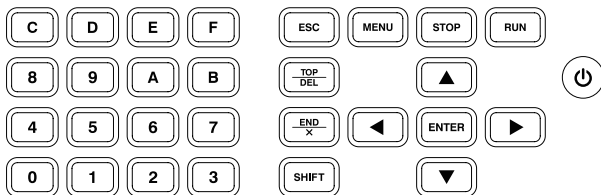

Operations	Function
[]	Turn ON/OFF the power. Press it longer to turn off the power.
[RUN]	Start monitoring, measuring or testing operation.
[STOP]	Stop monitoring, measuring or testing operation.
[MENU]	Return to the top menu.
[ESC]	Return to the previous display. Stop renewing data display while measuring.
[,]	Scroll one data line. Move the cursor on the condition setting.
[,]	Scroll one character of data. Change the setting on the condition setting.
[ENTER]	Apply selected settings.
[0] ~ [F]	Enter numerical values. Select the data send table number.
[TOP/DEL]	Jump to the top of data. Delete the entry indicated by the cursor.
[END/X]	Jump to the end of the screen. Enter the data of "Don't Care".
[SHIFT]	Press to use the expanded alternate function of each key.
[SHIFT]+[MENU]	Displays the operation menu while displaying measurement data
[SHIFT]+[ESC]	Save a screenshot or print it by a printer ^{*1}
[SHIFT]+[RUN]	Brighter the LCD back light.
[SHIFT]+[STOP]	Darker the LCD back light.
[SHIFT]+[1]+	Switch to analog measurement firmware ^{*2}
[SHIFT]+[3]+	Switch to high-speed communication measurement firmware ^{*2}
[SHIFT]+[0]+	Switch to normal communication measurement firmware
[ENTER]+[TOP/DEL]+	Initialize settings. Clear all.
[SHIFT]+[STOP]+	Start the firmware loader.

*This booklet uses [+] mark, when two keys need to be pressed at the same time.

* 1: Specify at the "Screen shot destination" in the Display/Print tab of the system settings.

* 2: Requires an option sold separately.

Initial Settings

Press  to turn on the power. Select language and set data & time.

*The top screen displays the model name.



Press [MENU] to set the initial settings. Swipe the screen to set all settings.

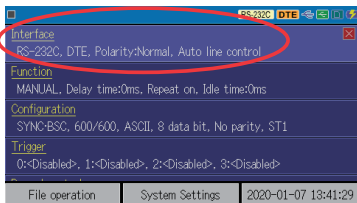

Touch the setting item or press [ENTER] key after selecting the item by [\blacktriangle] [\blacktriangledown] keys.

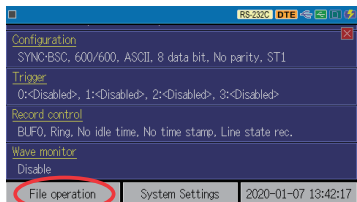



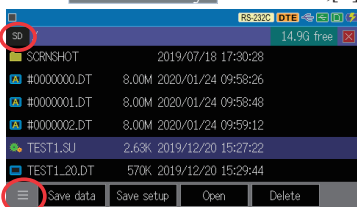

Touch “File operation” to save the settings or measured data.

Shortcut key [MENU] ,[C]

The left top of the screen indicates the storage device.



-  The filename extension “.DT” represents measured data file and “.SU” represents settings file.
-  Touch  to change the storage device (SD or USB) to filer saved files, or to filer the display by selecting the file type.
-  Double tap on the folder to check the files in the folder.

Interface Select a measurement port of analyzer.

Shortcut key [MENU] ,[1]

For Simulation, select DTE or DCE mode and polarity.

For Monitoring, polarity has to be set as well.

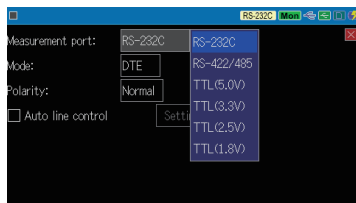

Function Select a function.

Shortcut key [MENU] ,[7]

- [Monitor Function] (P 15)
- [Simulation Function] (P 18)
- [BERT Functon] (P 21)

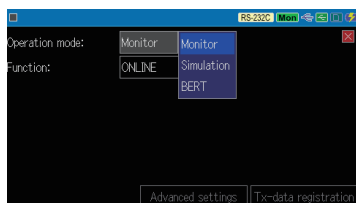

Select a mode for each function.

Select “ONLINE” for normal use of monitoring.

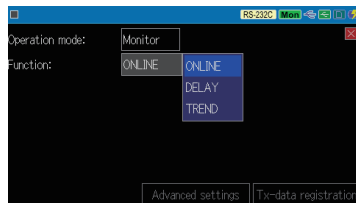

Depending on the function, touch “Advanced settings” or press [ENTER] to configure the operational condition.

LE-2500XR does not support TREND mode or function, BUFFER mode and PROGRAM mode of the simulation function.

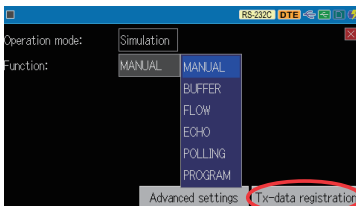

Touch “Tx-data registration” to register the data to be used in the simulation function.

Configuration Select basic communication conditions.

Shortcut key [MENU] ,[0]

Protocol :

Select Asynchronous (ASYNC), Character synchronous (SYNC, BSC), Bit synchronous (HDLC, SDLC), I2C or SPI.

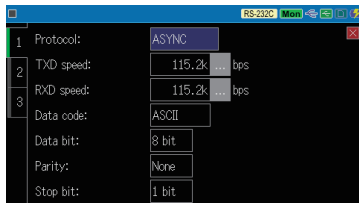

Speed :

Touch [] and select the communication speed. It is possible to type any speed (4 digits) by numerical key. ([C] represents “decimal point”. [D] represents “kilo”. [E] represents “mega”.

Other settings such as data code, data bit, parity, stop bit need to be set for some protocols.

BCC :

Select BCC type, begin code and end code etc. If selecting transparent mode, select DLE (Data Link Escape) code.

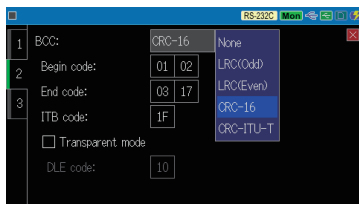

Bit sequence :

Select “LSB first” for normal use.

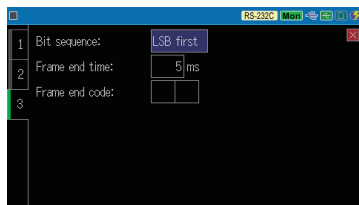

Frame end time :

Set the time of non-communication state which is recognized as a frame end.

Frame end code:

Frame end code can be set up to 2 characters.

- Frame end code is necessary to record time stamp.
- Necessary settings are different in each protocol.
- Auto configuration is available (P26).

Record control Set recording conditions of measured data.

Shortcut key [MENU] ,[3]

Touch the tab or press, [SHIFT]+[◀] or [SHIFT] + [▶].

■ Additional info.

Idle time :

Select ON/OFF of idle time (non-communication time) and time resolution.

Time stamp :

Select ON/OFF of time stamp and time resolution.

Line state :

Mark on the check box, then status of RTS, CTS, DCD, DTR, DSR, RI and TRG(trigger input) are recorded along with data.

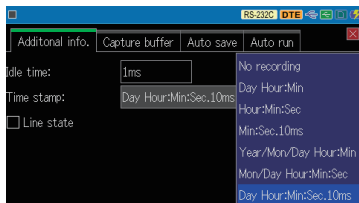

■ Capture buffer :

Recording area :

“BUF0” means full buffer. “BUF1/BUF2” means capture buffer is divided into two and use half of them for recording.

Protected :

Prevent data stored in the buffer memory from being inadvertently overwritten.

Write control :

Select Ring buffer (endless recording) or Full stop when the capture buffer is full.

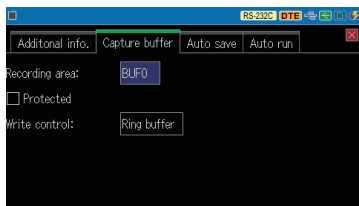

■ Auto save

Set conditions of auto save function to record data in the storage device.

→[Auto Save Function] (P 25)

→[Auto Backup Function] (P 26)

■ Auto run

Start measuring automatically at the specific period of time.

→[Auto Run/Stop Function] (P 26)

Trigger Set the trigger conditions.

→[Trigger Function] (P 22)

Wave monitor Set the conditions of logic analyzer function.

→[Timing Waveform Measurement Function] (P 24)

System Setting and Version

Press [MENU] and then touch “System Settings”.

Shortcut key [MENU], [D]

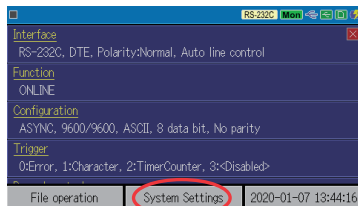

Touch the tab or press, [SHIFT]+[▶] or [SHIFT]+[◀].

■ Display / Print

It is able to adjust the brightness of LCD back light, set the power saving mode,

- Press [SHIFT]+[ESC] to save or print the screen images.

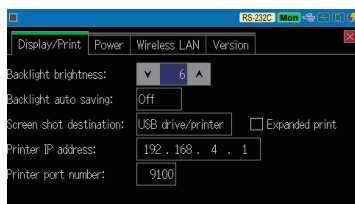

■ Power

Set ON/OFF of Auto Power Off function and select the charging type of Lithium ion battery.

- Auto Power Off function does not work during measurement.

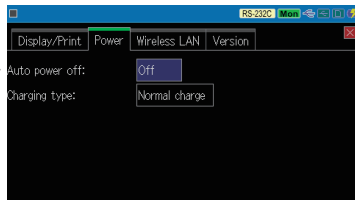

■ Wireless LAN

To enable this function, touch “Setting change” and select “Stations” mode or “Access Point” mode.
(Factory setting of Wireless LAN is Off.)

- Some models without this function do not have this setting.

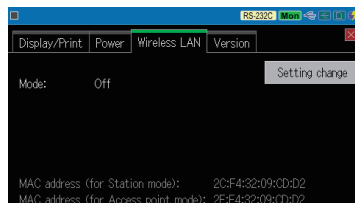

■ Version

Serial number and firmware version are displayed.

Connect to the Target Devices

■ Connect to RS-232C

Connect RS-232C connectors of the target devices to the RS-232C port of analyzer using monitor cable.

□ For monitoring

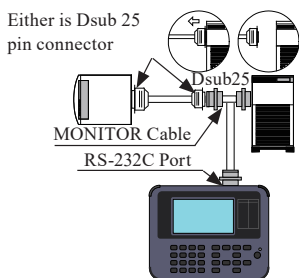

If the connector of either target device is Dsub 25 pin, use attached Dsub 25 pin monitor cable (LE-25M1) to connect to the analyzer.

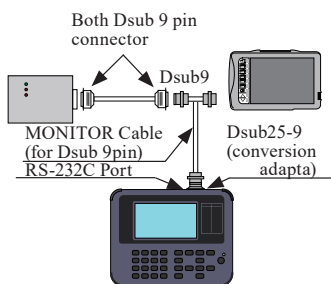

If the connectors of both target devices are Dsub 9 pin, use attached Dsub 9 pin monitor cable (LE-009M2) and Dsub 25-9 conversion adapter to connect to the analyzer.

□ For Simulation

Connect analyzer and target device one by one.

Connect as following, concerning the specification of target device (DTE/DCE) and RS-232C cable.

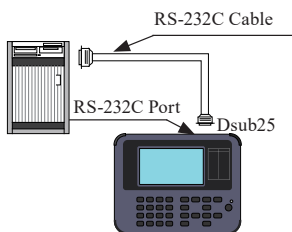

DTE device -----Straight cable -----Analyzer (DCE setting)
DCE device -----Straight cable -----Analyzer (DTE setting)
DTE device ----- Cross cable -----Analyzer (DTE setting)
DCE device -----Cross cable -----Analyzer (DCE setting)

■ Connect to RS-422/485

Connect appropriate signals of target device to the RS-422/485 port.

- Connect TXD+ and TXD-, and RXD+ and RXD- using twisted pair cable.

< RS-422/485 port >

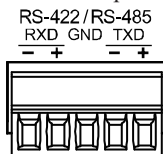

*This is the removable terminal.
Remove it from analyzer first, connect cables and return it to the analyzer.

□ RS-422 Full-duplex

Monitoring between A and B

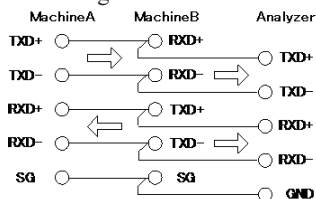

Simulating

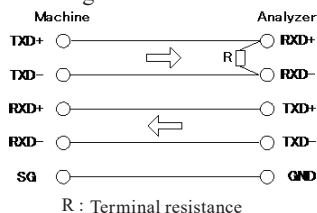

□ RS-485 Half-duplex

Monitoring/Simulating

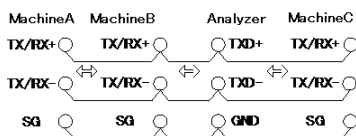

- If the analyzer is located as the terminal of communication line, set the Terminal resistance 120 Ω jumper pin to be "1" on the interface sub board. (JP1: TXD, JP2: RXD)

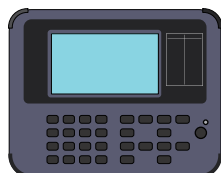
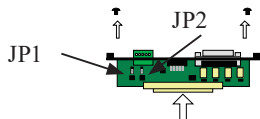
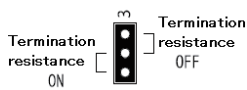

■ Connect to TTL interface

Connect appropriate signals of UART, I2C and SPI to the TTL port of analyzer using attached probe cable.

MIL box type 10pin header ^{*1}			Cable color
Signal Name	Pin	Input/Output	LE-5LS
TXD, SDA of I2C, SDO of SPI	1	I/O ^{*2}	Brown
RXD, SDI of SPI	3	I	Red
RTS, SS(CS) of SPI	5	I/O ^{*2}	Orange
CTS, SCL of I2C, SCK of SPI	7	I/O ^{*2}	Yellow
Signal ground	9	-	Green
Signal ground	2	-	
IN: Trigger input	4	I	
OT1: Trigger output 1	6	O	
OT2: Trigger output 2	8	O	
PWR: Power for external ^{*3}	10	-	

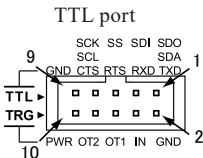

* 1: 2.54mm pitch. Equivalent to “HIF3FC-10PA-2.54DS(71)” of HIROSE Electric.CO.,LTD.

* 2: It is used for output of simulation, except SPI slave simulation (SS and SCK are inputs).

* 3: TTL voltage (max. 30mA) is outputted when simulating.

□ External Trigger Terminal

External trigger input level is LVTTTL (3.3V). External trigger output is open collector output type and pulled up in 5V by 10KΩ in the analyzer.

Attached 5-wire TTL probe can be used for connection of external trigger. To use the TTL probes for both TTL and external trigger, prepare additional one.

→[Trigger Function] (P 22)

5wire TTL probe (LE-5LS)

[Option]

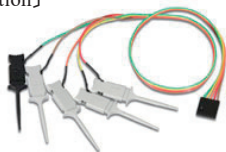

length : 360mm

If the target devices are easily affected by radiation noise from the analyzer, try to use the shielded cable and add the ferrite core on the cable.

■ Connecting and using analog pods (OP-8AH, OP-8AT)

Turn off the power and connect an analog pod (sold separately) to the TTL port.

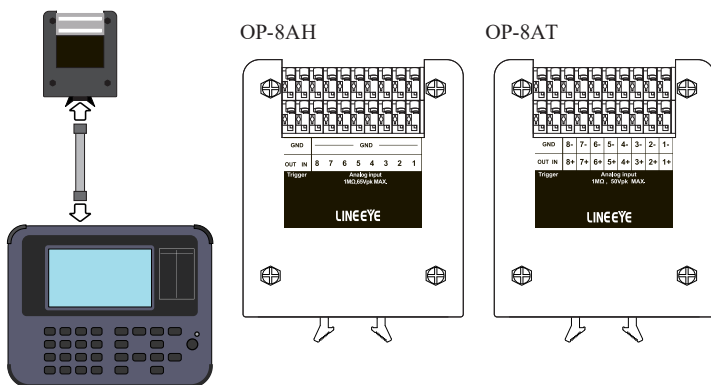

If you turn on the power while holding down [SHIFT] and [1], it will become an analog measuring instrument, and from the next time on, it will start up as an analog measuring instrument just by turning on the power.

*Turn on the power while holding [SHIFT] and [0] to return to the communication analyzer.

Set analog measurement conditions in “Interface/Configuration” in the top menu.

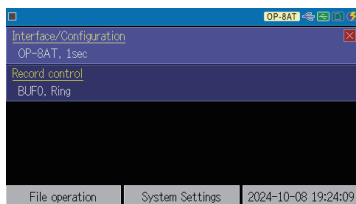

Selecting the model number of the analog pod to be used will change the required setting items.

See the instruction manual for details on setting items.

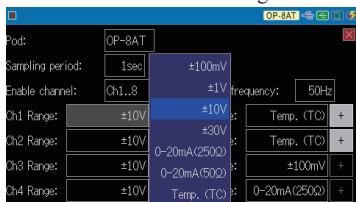

Connect the analog signal to be measured to the terminal block of the analog pod.

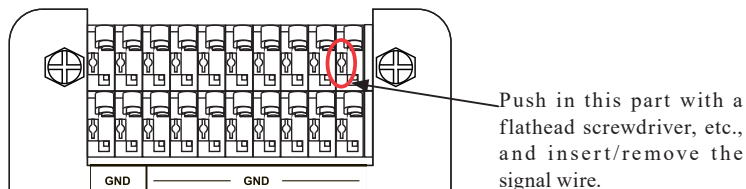

Please use an analog pod that corresponds to the analog signal.

	OP-8AH	OP-8AT
Measurement target	Voltage	Voltage, current, temperature
Input range	$\pm 60\text{V}, \pm 30\text{V}, \pm 16\text{V}, \pm 8\text{V}, \pm 4\text{V}$	$\pm 30\text{V}, \pm 10\text{V}, \pm 1\text{V}, \pm 100\text{mV},$ 0-20mA, Temperature (Thermocouple)
Measuring cycle	62.5 μsec to 4 msec	10 msec to 1 min
Measurement accuracy	60V range: $\pm(0.1\% \text{rdg} + 3\text{mV})$, 4V range : $\pm(0.1\% \text{rdg} + 2\text{mV})$	30V range : $\pm(0.05\% \text{rdg} + 3\text{mV})$, 0-20mA range : $\pm 0.05\% \text{FS}$
Dielectric strength	Non-isolated, common between input channels and analyzer GND	Between input and analyzer: 1500Vdc, Between input channels: 350Vdc

Connection example of OP-8AT:

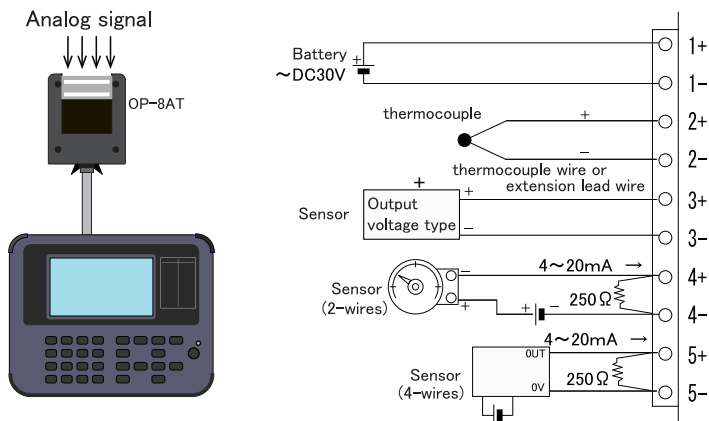

* Input channel 6/7/8 are also available.

Monitor Function

■ Start and Stop measurement



Press [RUN] to start monitoring. Measured data is displayed at real time and recorded in the capture memory. Send (TXD) data and receive (RXD) data are displayed in two lines as a pair. The latest data is displayed on the left side of “**□**” marker. Press [STOP] to finish measuring.

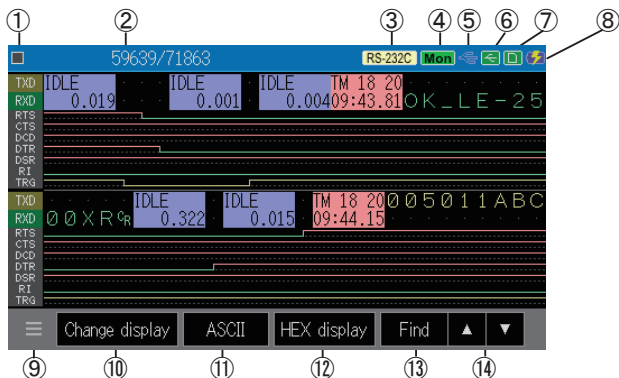

- When TXD and RXD are generated at the same time, they are displayed on the same column.
- Press [ESC] to pause the display.
- It is able to stop measuring automatically by setting the trigger function and record control (full stop setting on capture memory).
- Errors and breaks are displayed in unique characters.

Character	Description
PE	Parity Error (parity bit error).
FE	Framing Error (stop bit is “0”).
PF	Parity & Framing Error .
B	Break (start bit, character bit, (parity bit), stop bit are all “0”).
A	Abort (7bits or more of “1” is continuously detected).
SF	Short Frame (frame length is short).
G	Block check code normal (BCC or FCS is normal).
E	Block check code abnormal (BCC or FCS is abnormal).
7E	HDLC starting flag pattern (7Eh) is detected.
7F	HDLC ending flag pattern (7Eh) is detected.
03	Multi processor bit or acknowledge bit of I2C is “1”. (displayed in blue back).
7F	I2C (re)start sequence is detected.
7F	I2C stop sequence is detected.
OE	Overrun Error.
LD	Overload (Cannot save all data by auto save function).



①	Measuring [], Pause [] .
②	Position of data/ all data. Able to type the position of data. Speed and character framing while measuring (e.g. B8-PO-S1). ^{(*)1}
③	Selected interface.
④	Selected Mode. [Mon]: Monitoring, [DTE/DCE/Sim]:Simulating.
⑤	Status of USB device port (Bright: Connected).
⑥	Status of USB host port (Bright: Connected). ^{(*)2}
⑦	Status of SD card slot (Bright: Connected). ^{(*)2}
⑧	Level of remained battery. [] indicates “USB bus power”.
⑨	Display more setting items.
⑩	Change displayed mode. ├-->Normal-->Line state-->Each frame/ Translated ^{(*)3} --┤ ├-----Logic analyzer-----┤
⑪	Selected data code. Change data code.
⑫	Change display. HEX↔Data code.
⑬	Find specific data and errors.
⑭	Start retrieval.

* 1 : [B: Data length], [P: Parity (E: Even, O: Odd, N: None)], [S: Stop bit]

* 2 : A red dot appears in the mark while the storage device is being accessed.

* 3 : Translated display is difference by selected protocol.

Scroll data by swiping on the screen.

Swipe in upward to look older data.

Swipe in downward to look newer data.

 Press [SHIFT]+[▲] or [SHIFT]+[▼] to go to next/ previous page.

Do not remove the USB flash drive and SD card while measuring and displaying “under cleanup”.

■ Signal Voltage and Delay Time

Press [MENU]->“Function”->“MONITOR”->“DELAY Function” and then touch “Advanced settings”.

Set the start/ stop conditions of delay time for target signals.

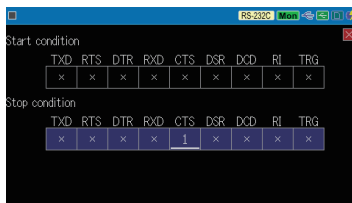

Press [RUN] to display the delay time and voltage (max./ min.).

- Use “Wave monitor” for delay time less than 0.1ms.

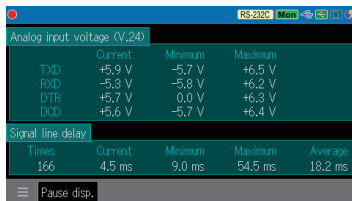

■ Statistic Function (TREND) [LE-3500XR only]

Press [MENU]->“Function”->“MONITOR”->“TREND” and then touch “Advanced settings”.

EVENT :

Select “Data”, “Frame” or “Trigger” to calculate.

Trigger: The number of the events which satisfies the trigger conditions set in factor of “TRIGGER 0” and “TRIGGER 1” are counted.

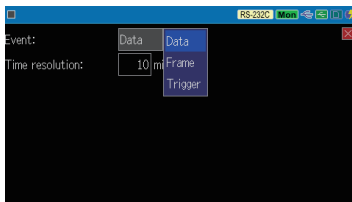

Press [RUN] to start the statistic.

As unit time of statistical processing passes, the results of calculated value will be updated on a bar graph.

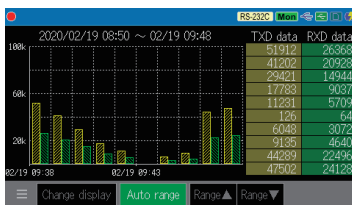

Simulation Function

You can execute a communication test for a device in development by sending/receiving data by the analyzer depending on the selected mode.

Registration of Transmission Data

Select the simulation function at “Operation mode” of [MENU], and then touch “Tx-data registration” to display the transmission data table.

Shortcut key [MENU], [9]

Up to 160 types of data can be registered in the 160 tables of 0 to 9 groups (each group has 16 tables). Touch the table and group to register the data in it.

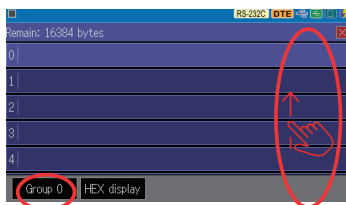

Input the data to be transmitted in HEX by [0] to [F].

Copy and paste of the data are available by [ENTER], [▶], and [◀].

- By touching “PE/MP”, the data on the cursor turns to be parity error or multi-processor bit, and by touching it again it returns to be the original one.

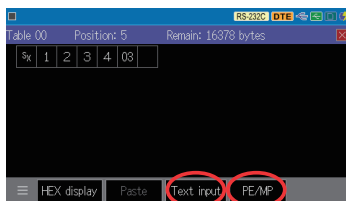

You can input text by touching “Text input”.

Input the text by capital letter or symbol and touch [ENTER] or “OK”, then the input text line is inserted to the cursor position.

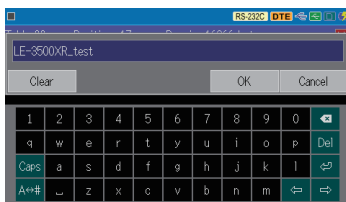

Touch “☰” to display menus such as fill data set, copy table, buffer copy. Touch each item to execute.



■ Start and Stop Measurement

Touch [RUN] to start the specified test function and touch [STOP] to stop it.

- When the analyzer is set to DTE, The TXD line means the data is transmitted from the analyzer. When the analyzer is set to DCE, the RXD line means the data is transmitted from the analyzer.

□ MANUAL Mode

Checking the data from the connected device on the display, you can transmit the preset data which you registered in advance by touching [0] to [F] or [SHIFT]+[0] to [SHIFT]+[D].

- While putting [SHIFT], the control guide for preset data is displayed.
- It can output break signal by [END/X].

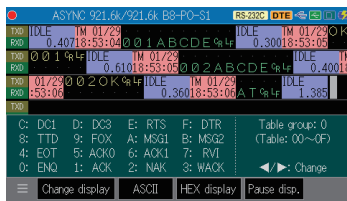
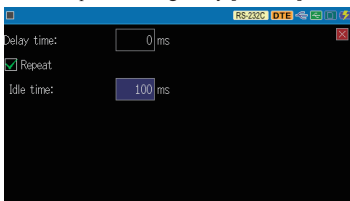

- You can specify the interval of each data, on/off of repeated transmission, and the interval of data frame.

□ FLOW Mode

This unit becomes the transmission side or reception side, and stats the simulation of flow control using X-ON/OFF and control lines.

When “Send test” is set, it can display the data of transmission between the start of transmission and the interruption request for 16 times.

In “Receive test”, you can specify the number of reception data until the transmission interruption request is issued and the time until the restart request of transmission is sent.

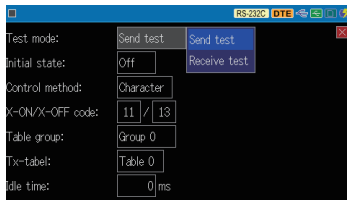

□ ECHO Mode

Received data will be returned inside the analyzer and returned to the sender. This mode is used for testing of devices such as display terminals and communication terminals.

When “Loop back” is set, data can be returned in bit units.

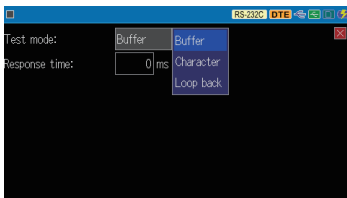

□ POLLING Mode

When the master mode is set, polling messages are sent to 32 types of slave address stations, and the returned data is checked and displayed for each slave station.

When the slave mode is set, the specified data is responded to the polling of the own station address, and the number of times and the presence/absence of an error are checked and displayed.

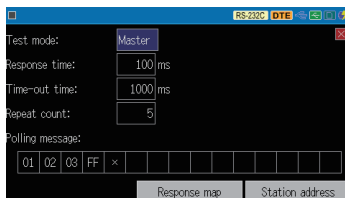

□ BUFFER Mode [LE-3500XR Only]

From the send/receive data stored in the memory by the monitor function, it transmits the data of send or receive line set in advance as it is.

This is effective for a reproduction test using the same data as the communication status monitored on site.

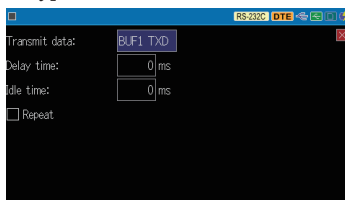

□ PROGRAM Mode [LE-3500XR Only]

You can easily test a communication protocol that involves condition judgment using a test program created using dedicated commands.

You can register four types of test programs A to D in advance by touching "Edit".

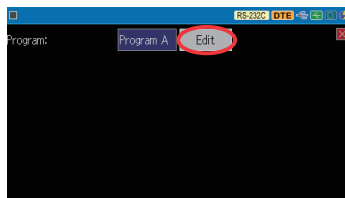

● Contents of setting example

- 000 : Label 000
- 001 : Waits for new received frame
- 002 : Transmits data of table 08
- 003 : Branches to label 000 when receiving N, G, CR, LF
- 004 : Increments the register 0
- 005 : Branches to label 000



BERT (Bit Error Rate Test) Function

■ Measurement Start and Stop

Select the test mode, test pattern, and on/off of RTS-CTS flow control in advance.

By pressing [RUN] it starts transmission of the specified test pattern and compares the received data with the test pattern. Then it measures the bit error rate etc. in compliance with ITU-T G.821 and displays them on the screen. It stops measurement by [STOP].

-  Set the synchronization method (ASYNC or SYNC/BSC) and the communication speed at the “protocol” and “speed” in the configuration. For the other items, only the data bit and stop bit settings are valid for ASYNC, and only the clock settings is valid for SYNC/BSC.

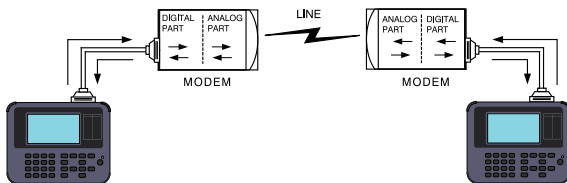
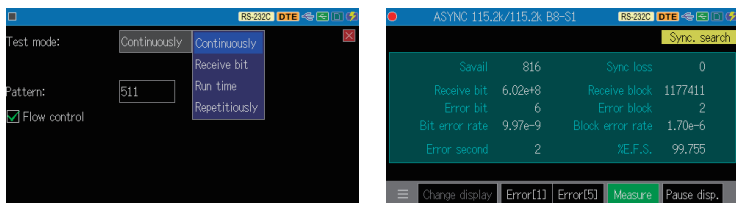

Item	Contents	Range of measurement
Savail	Effective time since the first synchronization was established	0 ~ 9999999(sec)
Receive bit	Number of received bits during synchronization establishment	0 ~ 9999999 ~ 9.99E9
Error bit	Number of bit errors	0 ~ 9999999 ~ 9.99E9
Bit error rate	Bit error rate	0.00E-0 ~ 9.99E-9
Sync loss	Number of loss of synchronization	0 ~ 9999
Receive block	Number of received blocks during synchronization establishment	0 ~ 9999999 ~ 9.99E9
Error block	Number of blocks with bit errors	0 ~ 9999999 ~ 9.99E9
Block error rate	Block error rate	0.00E-0 ~ 9.99E-9
Error second	Time when bit error was detected during Savail	0 ~ 9999
%E.F.S.	Errored second rate (%)	0.000 ~ 100.000(%)

Useful Functions

■ Trigger Function

By this function it executes a special measurement processing (“Action”) triggered by specific conditions (“Factor”) such as the occurrence of a communication error during the measurement or reception of the specified data.

[Factor]

Error	Communication error, break, multiprocessor bit on
Character	Communication data of up to 8 characters
Line state	Logic state of interface signal line and external trigger input
Timer/Counter	Timer/Counter value match
Idle time	Idle time exceeding the specified time

[Action]

Buzzer	Buzzer sound
Stop measurement	Stops the measurement/test (offset to stop can be specified.)
Save data	Save data before and after the trigger to the storage device
Timer control	Start/stop/restart of the timer 0/1 for trigger
Counter control	Count up/clear of the counter 0/1 for trigger
Trigger control	Enables/disables/inverts the state of trigger condition
Transmit data	Transmits the specified character string (in MANUAL simulation)
OT2 pulse output	Outputs an L pulse of about 1 ms to external trigger terminal OT2

Press [MENU] and touch “Trigger” to display the current trigger settings.

Shortcut key [MENU] ,[2]

The trigger number with check mark is valid. If you check more than one, it will be OR condition.

Touch or [SHIFT] + [0] to [3] to turn the check mark on/off.

Touch the factor or action to be changed and configure it.

Touch “Timer/Counter” settings to set the comparison values for timer/counter used in the trigger function.

- These timers and counters are cleared at the start of measurement, and the timer will be stopped state.

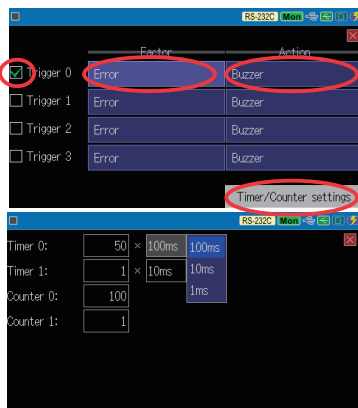

Setting example 1:

When you want to notify an external measuring instrument that a block check error has occurred.

Turn on the check mark of the trigger to be used and touch the trigger factor. Select “Error” on the trigger factor setting and check the BCC error you want to detect.

Press [ESC] to return to the trigger setting screen, then touch the corresponding trigger action and select “OT2 pulse output”. With this setting, when a BCC error is detected, it outputs an L pulse of about 1 ms to the external trigger output terminal OT2. Observe the OT2 signal by connecting measurement device such as an oscilloscope.

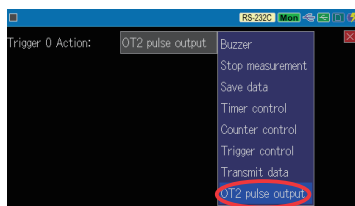
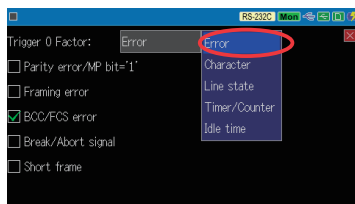

- Regardless of the trigger action setting, it outputs an L pulse of about 1 ms to the external trigger output terminal OT1 when any trigger factor matches.

Setting example 2:

When you want to stop the measurement immediately when receiving the character string of 41h, 42h, 30h or 41h, 42h, 31h on the transmitting side.

On the setting screen of the checked trigger factor configurer as shown on the right. For the third byte of the character string to be detected we use the bit mask W0 to set bit 0 to don't care (X).

Press [ESC] to return to the trigger setting screen and touch the corresponding trigger action. Select “Stop measurement” on the trigger action setting screen.

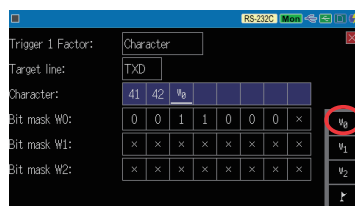

- You can specify whether to stop measurement immediately or stop after receiving data by “Stop”.

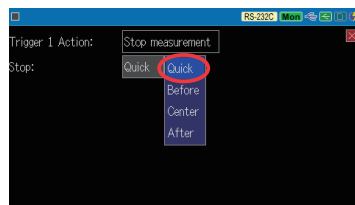

■ Timing Waveform Measurement Function

This function periodically records the logical state of the communication line and displays the timing waveform like a logic analyzer.

Press [MENU] and touch “Wave monitor”.

Shortcut key [MENU] ,[4]

Mark on the box of Enable wave monitor and configure the sampling clock (20ns to 1ms), trigger position, and trigger pattern.

(Trigger position in memory)

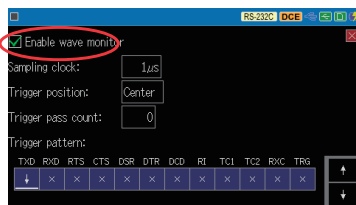
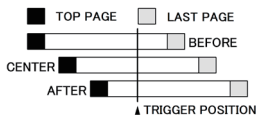

Set the sampling clock to approximately 5 times the communication speed as a guide.

“↓” and “↑” can also be entered by [SHIFT] + [0] or [SHIFT] + [1].

When measurement is started by [RUN], the status of the communication line is recorded in the waveform recording memory at the specified cycle while normal operation is executed.

will be displayed at the upper left of the screen until the trigger is established and the waveform recording ends.

After the measurement is stopped, press “Change display” for several times to switch to the following screen.

Touch the magnification to zoom in and out, and swipe left or right to scroll to the part you want to see.

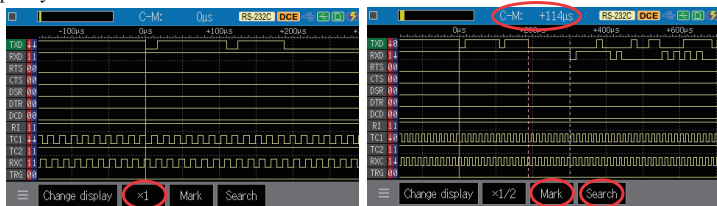

The red vertical line is the trigger point. At first, cursor C (blue dotted line) and marker M (red dotted line) overlap the trigger point.

○ Time measurement between two points

The time between the cursor and the marker is displayed at “C-M:”.

The cursor can be moved by [▶] and [◀], and becomes a marker by touching [ENTER] or “Mark”.

○ Search waveform

Touch “Search” and enter the state of the waveform you want to search by [▶] and [◀] to move the cursor to the first matching waveform in that direction. Touch “Search” again to exit from the search mode.

■ Auto Save Function

With this function, it automatically saves the communication data as a measurement log file in the optional SD card or USB flash drive while measuring. Since long time communication data can be recorded, it is useful to clarify rare communication failures of unknown cause.

Press [MENU], and then touch “Record control” and “Auto save” in order.

Save device:

Set the save destination of the log file.

Insert the SD card or USB flash drive as selected.

Auto save :

Restart Continuous ring recording up to the maximum number of files.

Max-stop Saves up to the maximum number of files and stops measurement.

Append Continuous ring recording from the continuation of the existing auto save file.

- ☰ Please note that except for “Append” all the existing auto save files will be deleted at the start of measurement.
- ☰ Set the main unit memory to “Ring buffer”.

→ [MENU], “Record control”, and then “Write control” of “Capture buffer”.

File size :

Set the size of the communication log file to be automatically saved.

Max files :

Set the maximum number of files to be recorded.

- ☰ The communication log file name is # XXXXXXXX.DT (XXXXXXX is a sequential number that increases by 1 from 0000000).

When you start the measurement by [RUN], a confirmation message for overwriting the file will be displayed. Touch [RUN] or “Continue” to start measurement. If you do not want to lose the communication log file and want to save it to another device, press [STOP] and save it to a PC or other device.

If the power is turned down during auto save because of low battery charged, it may cause damage to the saved files and the storage device. Start measurement with the sufficiently charged battery.

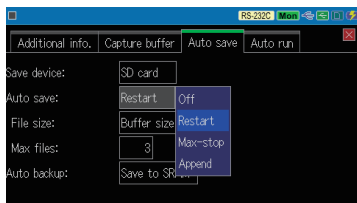
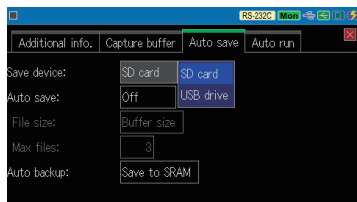

■ Auto Backup Function

Since the capture memory is DDR3-SDRAM which loses data when the power is turned off, at the end of measurement the analyzer automatically backs up the about 512 KB of the latest part of the measurement data into the SRAM backed up by the battery. To automatically save the entire measurement data or to erase the data when the power is turned off, change the setting of the auto backup function.

Press [MENU], and then touch “Record control” and “Auto save” in order.

Auto backup:

- Off No automatic backup.
- Save to SRAM Save about 512 Kbytes of the latest data into internal SRAM.
- Save to File Save all the measurement data to the storage device

- ☰ The data saved in the SRAM is automatically loaded into the capture memory when the power is turned on.
- ☰ The file automatically saved in the storage device, @AUTOBU.n.DT (n is the number of the used capture memory - BUF0, BUF1, or BUF2), needs to be loaded manually to use.

■ Auto Run/Stop Function

By specifying the date and time for the start and end of measurement, it automatically executes measurement for the specified period.

Press [MENU], and then touch “Record control” and “Auto run” .

Mode:

Select the repeat condition for automatic measurement.

Touch to activate the checked item.

Set the automatic measurement period for “Run time” and “Stop time”.

With the settings on this screen, measurement starts at 12:30 every day and ends automatically at 13:00.

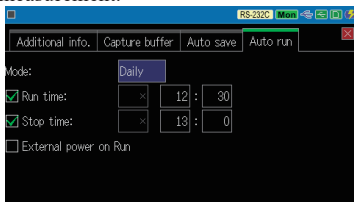

- ☰ If you want to start the measurement in conjunction with the power on of the target line, check “External power on Run”.

■ Communication Condition Auto Setting Function

The monitor processing of the analyzer estimates the communication conditions of unknown communication lines for measurement.

By touching “Auto Configuration” in the [☰] menu, “Analyzing transmission speed...” is displayed and the analysis process of communication condition starts.

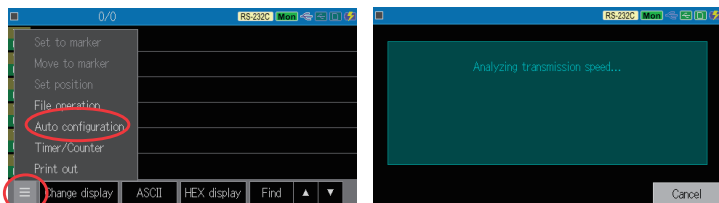

When the communication conditions are determined, the details will be displayed. A few seconds after that, the current communication condition settings are automatically changed to the determined communication conditions and it starts the measurement.



- ▮ If you touch “Cancel” or press [STOP] or [ESC] before starting measurement, the communication condition analysis process will be stopped and the current communication condition settings will not be changed.
- ▮ The following conditions are required for the line to be measured in order to judge the communication conditions correctly.
 - Communication speed is 460.8Kbps or less.
 - Protocols are ASYNC, SYNC/BSC, or HDLC/SDLC.
 - On the line communication data without error is flowing at a certain frequency.
 - On the line communication data including bit patterns of ‘101’ or ‘010’ is flowing.

■ Conversion and saving, and print function for the measurement data

Measured data can be converted to text and saved to a storage device, or printed continuously by a dedicated printer.

In the [☰] menu at the bottom left of the measurement data display screen, touch “Print out”, specify the output destination and the target range from the current display screen, and click “OK”. When the output destination is the storage device the text file is saved, and it is a dedicated printer the measurement data is printed out continuously.

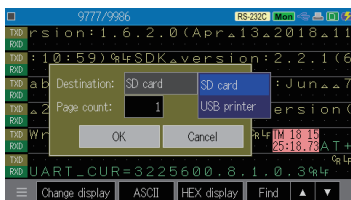

Measurable Interface Expansion

By using the option for measurement expansion, you can expand the communication target to be measured.

■ Exchange the board

Remove the standard interface sub board and replace it with the optional interface sub board.

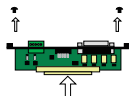

- TTL communication with synchronous clock
Use OP-SB5GL.

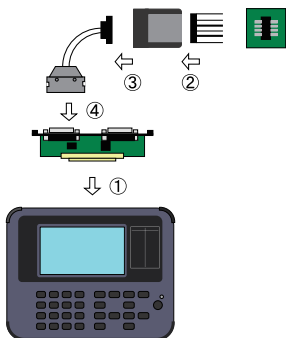

- In-vehicle communication CAN FD / CXPI
Use OP-SB7XC.

- In-vehicle communication CAN FD / LIN
Use OP-SB7XL.

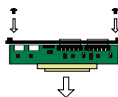

■ Loading and switching of extended firmware

The firmwares for expansion options are available on the LINEEYE website. Load it to the analyzer using le8firm.exe included in the attached CD. Once written, the corresponding firmware starts up simply by replacing the sub-board.

- 📄 When using the optional high-speed firmware OP-FW10XR, you can switch between standard firmware and high-speed firmware by turning on the power pressing [SHIFT] and [0] or [SHIFT] and [3].

Specifications of Function and Hardware

Item	LE-3500XR(V2)	LE-2500XR(V2)
Interface	RS-232C, RS-422/RS-485, TTL (1.8V, 2.5V, 3.3V, 5V level)	
Protocol	ASYN (Asynchronous), ASYN-PPP, Character synchronous SYNC/BSC, Bit synchronous HDLC/SDLC/X.25, I2C, SPI, Burst	
	Modbus	-
Expansion measurement option ^{*1}	CAN/CAN FD/LIN, CAN/CAN FD/CXPI, X.20/21, RS-449, V.35, RS-530, Current loop communication	
Capture memory	DDR3-SDRAM 100MB, 2-split usage is available	
Baud rate (bps)	50bps ~ 3.150Mbps ^{*2}	50bps ~ 1.544Mbps
Speed setting range	Freely set separately for transmission and reception. (Margin of error: ±0.01% or less)	
Data format	NRZ, NRZI, FM0, FM1	
Data code	ASCII, EBCDIC, JIS, Baudot, Transcode, IPARS, EBCD, EBC-DIK, HEX	
Measurement function	Monitor function, Simulation function, BERT function	
Buffer transmission	○	-
Program mode	○	-
Statistic analyze function	○	-
External trigger	LVTTL input 1, Open collector output 2	
Signal voltage measurement	±18V input range ^{*3} , 0.1V resolution	
LED	Green/red two-color light, 11 for line status, 1 for power supply	
Display	4.3 inch TFT color display (480x272dot)	
Operation part	Capacitance touch panel and 29 buttons	
USB 2.0 device port	USB Type-C connector, High speed	
USB 2.0 host port	Standard A connector, High speed ^{*4}	
SD card slot	Supports SDHC card ^{*5} . Conforms to the SD association standard.	
Wi-Fi connection	IEEE 802.11 b/g/n	
	Frequency range : 2400MHz-2483.5MHz Transmission power : +20dBm(802.11b), +17dBm(802.11g), +14dBm(802.11n)	
Power	USB bus power 5V/1A	
	Lithium-ion rechargeable battery operation time: about 7 hours ^{*6}	
Temperature	In operation : 0 to 40 degree Celsius, In storage : -10 to 50 degree Celsius	
Humid	5 to 85% RH (no condensation)	
Standard	CE (class A)	
Size & weight	190(W)x153(D)x38(H)mm, Approx 550g	

* 1 : Optional measurement board or optional cable is required depending on the target.

* 2 : Up to 10Mbps is possible by adding the optional high-speed HDLC/SPI communication firmware OP-FW10XR.

* 3 : SD (TXD), RD (RXD), ER (DTR), and CD (DCD) of RS-232C and 4 communication lines of TTL port can be measured.

When measuring the TTL port, the input voltage range is -1 to 6V.

* 4 : For a USB memory or dedicated printer. Not all USB memory devices and printers are supported.

* 5 : For optional SDHC card sold by LINEEYE.

* 6 : Based on our measurement conditions.

For any technical issues

Read “FAQ” in our website or email us.

<https://www.lineeye.com/html/contactus.html>

LINEEYE CO., LTD.

4F., Marufuku Bldg., 39-1, Karahashi Nishihiragaki-cho, Minami-ku, Kyoto, 601-8468, Japan

Tel : 075(693)0161 Fax : 075(693)0163

URL <https://www.lineeye.com>

Printed in Japan

M-35235V2QE/LE