

# LINEEYE

*MULTI PROTOCOL ANALYZER*

***LE-3500XR(V2)***

***LE-2500XR(V2)***

---

---

**INSTRUCTION MANUAL**

---

---



## Instruction

---

Thank you for your purchase of LE-2500XR /3500XR .

To use it correctly, you are advised to read and understand this instruction manual thoroughly. Keep this together with the warranty. If you encounter any problems, you will find helpful information in this manual.

### NOTICE

---

It is prohibited to reprint or duplicate any part of the whole of this instruction manual without prior permission from LINEEYE.

The content of this instruction manual and specifications of the products are subject to change without any notice.

This instruction manual has been designed and edited with great care to give you all necessary information. If you have any questions, feel free to direct your inquiries to LINEEYE.

LINEEYE makes no warranty or guarantee, either expressed or implied with respect to its quality, performance, merchantability, or fitness for a particular purpose. LINEEYE shall not be liable for direct, indirect, special, incidental, or consequential damages resulting from any defect in the product. The warranty and remedies set forth above are exclusive and in lieu of all others.

### USER LIMITATION

---

This product has not been developed for the use that needs exclusively high reliability and safety: aerospace apparatus, trunk communication apparatus, nuclear control apparatus, medical apparatus related with life maintenance etc. Therefore, do not use for those purposes.

LE-series models with Wi-Fi function (IEEE 802.11b/g/n) emit radio wave. Please do not use it near a medical device, microwave, high-level electronics, TV, radio, wireless station for mobile communication, or specified low power radio station. To use LE-series in the place where an administrator limits the use of radio devices, follow the instruction of the administrator.

The Wi-Fi module used for the LE-series conforms to SRRC(China), FCC (USA), CE (EU), TELEC (Japan), KCC (Korea), ISED (Canada), NCC (Republic of China), however, as its product (LE-series) the Wi-Fi function is available only in Japan, USA, Canada, and EU nations in compliance with RE directive (2014/53/EU).

To use the product other than above countries, order LE-series without Wi-Fi function. Please contact the sales department for more details.

=== Notice ===

This product contains a battery.

To keep the quality of the battery, LINEEYE does not fully charge the battery.

Before using the battery, please make sure to charge the battery. When you dispose of it, please follow the regulation of the region.

# Safety Information

## Read this first !!

This Safety Information includes the following important information in order to not only have you learn the right way to use the analyzer, but also prevent you from causing damage to people and property. Before using, please read the main contents after you understand the following symbols & marks.



Warning

Should the device be used without following these symbols, there is a possibility of accidents, such as a death or a serious injury, occurring.



Caution

Should the device be used without following these symbols, there is a possibility of accidents, such as an injury <sup>(\*)</sup>, and material damage <sup>(\*\*)</sup> occurring.

\*1 “Injury” indicates injury, burn and electric shock, or the like which does not require hospitalization or the extended hospital visit.











\*2 “Material damage” indicates damage related to a house, a building, furniture, apparatus, livestock or a pet.







Prohibition





The necessary

 Warning	
	<ul style="list-style-type: none"> <li>Do not disassemble, modify or repair the line monitor. This may result in an injury, electric shock, and ignition.</li> </ul>
	<ul style="list-style-type: none"> <li>Turn off the power of analyzer and unplug the cables immediately when emanating smoke, odor or sound. Continuous use may result in an electric shock, injure or ignition.</li> </ul>
	<ul style="list-style-type: none"> <li>Do not use the line monitor if there is inflammable gas. This may result in ignition and explosion.</li> </ul>
	<ul style="list-style-type: none"> <li>Turn off the power and unplug the line monitor immediately when liquid or foreign substance gets into the line monitor. Continuous use may result in ignition, electric shock and malfunction.</li> </ul>
	<ul style="list-style-type: none"> <li>Do not touch the line monitor with wet hand. This may result in an electric shock and malfunction.</li> </ul>
	<ul style="list-style-type: none"> <li>Do not use the battery other than attached Lithium ion battery. Do not short the electrode of the battery. Do not modify, decompose or heat the battery. It may cause the ignition and explosion.</li> </ul>
	<ul style="list-style-type: none"> <li>Do not give a strong impact on the product, such as dropping and crashing.</li> </ul>
	<ul style="list-style-type: none"> <li>Do not use the battery charger other than attached one. It may cause the generation of heat, ignition, leaking and malfunction.</li> </ul>
	<ul style="list-style-type: none"> <li>Do not use the battery pack other than attached one. It may cause the generation of heat, ignition, leaking and malfunction</li> </ul>

 Caution

	<ul style="list-style-type: none"><li>• Do not leave the analyzer in the following conditions.<ul style="list-style-type: none"><li>• Strong magnetic field, static electricity or dusty place.</li><li>• Temperature and humidity above the specification or where dew condensation appears.</li><li>• Not flat, or shaking place.</li><li>• Place with leaking water or electricity.</li><li>• Place affected by direct sun or near the fire.</li></ul></li></ul> <p> Please do not leave the analyzer in the car during the summer.</p>
	<ul style="list-style-type: none"><li>• Do not use at the following situations. The radio wave by the analyzer may cause trouble.<ul style="list-style-type: none"><li>• Near a medical device such as cardiac pacemaker or hearing aid.</li><li>• Near an automatic controller such as fire-alarm box or automatic door.</li><li>• Near a microwave, high-level electronics, TV, or radio.</li><li>• Near a wireless station for mobile communications or a specified low power radio station.</li></ul></li></ul>
	<p>Remove the battery from the analyzer, when you throw away.</p>

 Caution

	<ul style="list-style-type: none"><li>• Please follow the instruction for the USB Battery Charger. It may cause the generation of heat, injure, electric shock and malfunction<ul style="list-style-type: none"><li>• Do not use it for other than AC 100V to 240V.</li><li>• Do no use when it brakes.</li><li>• Do not twist or step on the cable of charger. (Do not stress the base of cable.)</li><li>• Do not place near the heater or put in the fire.</li><li>• Do not disassemble, modify the USB Battery Charger or cable.</li><li>• Do not curve the cable around the USB Battery Charger.</li><li>• Do not put many loads on one electrical outlet.</li></ul></li></ul>
	<ul style="list-style-type: none"><li>• Insert it well to the electrical outlet.</li><li>• Remove the dust on the AC plug.</li><li>• Unplug the charger if you do not use it.</li><li>• When unplugging from the outlet, pull out the body straight.</li></ul>

# CONTENTS

---

Instruction .....	1	Change Display Code .....	34
NOTICE .....	1	Display Time Information .....	35
USER LIMITATION .....	1	Line State Display .....	35
<b>Safety Information</b> .....	<b>2</b>	Change Display Format .....	36
Read this first !! .....	2	End of Measurement .....	36
<b>Chapter 1 Before Using the Product</b> .....	<b>6</b>	Scroll and Jump .....	36
1.1 Description on This Manual .....	6	Mark & Jump .....	37
Function for different model .....	6	Protocol Translation Display .....	38
Deception of the Operating Procedure .....	6	Bit Shift Function .....	41
1.2 Unpacking .....	6	3.2 Retrieval Function .....	41
1.3 Functions and Feature .....	7	Retrieval Setting .....	41
Features .....	7	Start Retrieval .....	42
Optional Accessories .....	7	3.3 Delay Time and Signal Voltage (DELAY) .....	43
1.4 Name of Each Part .....	8	Setting .....	43
General .....	8	Start and End of Measurement .....	43
LED and Display .....	9	3.4 Statistic Analysis Function (TREND)	
Key operation .....	10	[LE-3500XR only] .....	44
1.5 Power Supply and Battery .....	11	Setting .....	44
<b>Chapter 2 Basic Operation and Set-up</b> .....	<b>12</b>	Start and End of Measurement .....	45
2.1 Power Source ON (Opening Screen) .....	12	<b>Chapter 4 Simulation Function</b> .....	<b>46</b>
Power Source ON .....	12	4.1 Register Transmission Data .....	47
Language (English or Japanese) .....	12	Register data .....	47
Time and Date Setting .....	12	Data Editing Method .....	49
Power Source OFF .....	12	Fixed Transmission Data (Pre-set data) .....	50
2.2 Top Menu .....	13	Register I2C Simulation Data .....	51
2.3 Measurement Port .....	13	4.2 RS-422/485 Driver Control .....	52
2.4 Measurement Function .....	15	4.3 Auto Line Control .....	53
2.5 Communication Condition .....	16	4.4 Manual mode .....	54
Protocol .....	16	Setting .....	54
Communication Speed .....	17	Operation .....	55
Arbitrary Speed .....	17	4.5 Buffer Mode .....	56
Details of Each Protocol Setting .....	18	Preparation .....	56
2.6 Record Control .....	24	Setting .....	56
Idle time .....	24	Operation .....	57
Time stamp .....	24	4.6 Flow Mode .....	57
Line state .....	24	Setting .....	57
Dividing a Capture Buffer .....	25	Operation .....	58
Buffer Full Stop .....	25	4.7 Echo back test (ECHO mode) .....	60
2.7 System Menu .....	25	Setting .....	60
Backlight and Saving Screen Shot .....	25	Operation .....	61
Auto Power Off and Charging Battery .....	26	4.8 Polling mode .....	62
Wi-Fi Setting .....	27	Setting .....	62
2.8 Connect to the Target Devices .....	29	Slave mode .....	62
Connect to RS-232 .....	29	Master mode .....	63
Connect to RS-422, RS-485 .....	30	4.9 Program mode .....	66
Connect to TTL .....	31	Outline .....	66
Expansion Interfaces .....	32	Program input .....	67
<b>Chapter 3 Monitor Function</b> .....	<b>33</b>	Operation .....	68
3.1 Online Monitoring (ONLINE) .....	33	4.10 Commands for Program Mode .....	69
Setting .....	33	NOP Command (Invalid Command) .....	70
Operation .....	33	SEND Command (Data Transmission Command) .....	70
Stop Renewing Display .....	33	WAIT Command	
Character .....	34	(Command to Halt Program Execution) .....	72
		GOTO Command	
		(Designated Label Number Branch Command) .....	74

IF Command (Conditional Comparison Branch Control).....	74	Chapter 8 Save and Load of the Data	106
CALL Command (Subroutine Call Command).....	76	8.1 Storage device .....	106
RET Command (Command to Return from Subroutine).....	77	8.2 File Management Function .....	106
SET Command (Device Setting Command).....	77	Save data.....	107
INT Command (Trigger Interrupt Command).....	79	Save setup.....	107
RETI Command (Trigger Interrupt Reset Command).....	80	File sorting and display filters .....	107
DISI Command (Trigger Interrupt Disable Command).....	80	Load file.....	109
STOP Command (Program Quitting Command).....	80	Delete a file.....	109
LBL Command (Command to Define Label).....	80	Error message.....	110
<b>Chapter 5 BERT Function</b>	<b>82</b>	8.3 Text conversion and printing function of measurement data ...	111
5.1 Connection and Settings .....	82	Text conversion and its saving of the measurement data ...	111
Loopback test.....	82	When printing via USB .....	111
End-to-End Test .....	82	Print/text conversion format of measurement data...	112
Setting of Test Mode.....	83	When printing via Wi-Fi.....	112
5.2 Start and Stop.....	84	<b>Chapter 9 PC Link</b>	<b>116</b>
5.3 Contents of the Line Quality Data.....	85	9.1 PC link software.....	116
<b>Chapter 6 Useful Functions</b>	<b>86</b>	9.2 Usage of Screenshot.....	118
6.1 Trigger Function.....	86	9.3 Take the data file while measurement.....	118
External trigger input/output.....	86	LE file downloader.....	118
Setting .....	87	How to use.....	118
Trigger Factor.....	87	9.4 Key Emulation Software.....	119
Trigger Action.....	88	9.5 PC Remote Control Library.....	119
Trigger Setting Example.....	90	<b>Chapter 10 Documents</b>	<b>120</b>
6.2 Timer/Counter Function .....	91	10.1 Calculation of the Block Check.....	120
Setting .....	91	10.2 Send/Receive Clock .....	121
Timer action .....	91	10.3 About the Frame.....	122
Counter action.....	91	10.4 Data Code Chart.....	123
Display of timer / counter value .....	92	10.5 Translation Display Specification .....	127
6.3 Timing Waveform Measurement Function .....	92	Frame level translation display.....	127
Setting .....	92	Packet level translation display .....	130
Control.....	93	PPP translation display .....	132
Display.....	93	MODBUS translation display .....	135
6.4 Auto Configuration Function.....	95	<b>Chapter 11 Specifications and Maintenance</b>	<b>136</b>
How to use.....	95	11.1 Specifications of Function and Hardware .....	136
6.5 Auto Save Function.....	96	11.2 Signal Definition of the Measurement Ports....	139
Preparation and settings .....	96	11.3 Shortcut Keys .....	143
Start measurement .....	97	11.4 Software Reset.....	143
Check files by Wi-Fi connection .....	98	11.5 Firmware Update.....	144
End of measurement .....	98	11.6 Trouble shooting.....	145
6.6 Auto Backup Function.....	98	11.7 Warranty and After service.....	146
6.7 Auto Run Function.....	99	Warranty.....	146
Setting .....	99	User Registration .....	146
Control.....	99	Repair .....	146
<b>Chapter 7 How to use as an analog measuring instrument</b>	<b>100</b>	Maintenance parts.....	147
7.1 Preparation for analog measurements.....	100	After Support .....	147
7.2 Analog Measurement Mode.....	102		
7.3 Analog Measurement Mode.....	102		
7.4 Start of analog measurement.....	104		
7.5 CSV conversion for Analog data .....	105		

## 1.1 Description on This Manual

---



### Function for different model

---

- This manual describes functions and performance of LE-3500XR and LE-2500XR. If only one model has specific function, model name is wrote next to the description of function.
- A model number LE-3500XR(V2)/LE-2500XR(V2) is written as LE-3500XR/LE-2500XR, unless explaining a special function of LE-3500XR(V2)/LE-2500XR(V2).

### Deception of the Operating Procedure

---

- Printed representation of screen displays in the manual may not be the same as that actually displayed concerning the font and special symbols.
- Descriptions of items of the screen are enclosed in double quotation marks “ ”.
- Reference page is described with  .
- Represent key is enclosed in [ ].  
e.g. Press “  ” key. : Press [MENU].
- Successive key or touch operations may be represented by putting their symbols one after another.  
e.g. Press [MENU], then press [0]. : Press [MENU] -> [0].  
e.g. Touch [A], then touch [B]. : Touch [A] -> [B].
- Pressing two keys at the same time is represented by combining their symbols with “+”.  
e.g. Press [SHIFT] and [ESC] at the same time : Press [SHIFT]+[ESC].

## 1.2 Unpacking

---

When you unpack the product, check the items below:

- The product has not been damaged during the transit.
- You have received all the standard accessories listed below.
  - Protocol Analyzer 1
  - Interface Sub-board (attached to the analyzer) 1
  - DSUB 25pin Monitor cable (Model: LE-25M1) 1
  - DSUB 9pin branch cable (Model: LE-009M2) 1
  - DSUB 25-9 conversion adapter 1
  - 5-wire TTL probe (Model: LE-5LS) 1
  - USB 2.0 Cable (Type A-C) 1
  - Carrying bag (Model: LEB-01) 1
  - USB charger (Model: LE-P2USB) 1
  - Utility CD 1
  - Quick Start Guide 1
  - Warranty 1

 The card packed with the product is the user registration card for Japanese customers. For overseas customers, there is a user registration page on our web site.( <https://www.lineeye.com> )

Please let us know if you find any damage to the product or accessories lacking.

### ○ Utility CD

Utility CD contains following files.

Manual folder: Instruction manuals for analyzer and its options.

Utility folder: PC link software (light edition), Utility software, Software for transferring firmware

Driver folder: USB driver for linking with PC.

## 1.3 Functions and Feature

---

LE-3500XR(V2)/LE-2500XR(V2) is the successor model of LE-3500XR/LE-2500XR. It covers all functions of the conventional model including the analysis test function of communication data on RS-232C/RS-422/RS-485/TTL, and expansion for other communication by its options. In addition, the new feature of analog measurement logger is equipped. At the time of the developing test of the communication system, it is available as a high-performance protocol analyzer. And, at the time of measuring the voltage and temperature, it is available as a high-precision data logger.

 To use it as an analog measurement logger, an optional analog pod is necessary.

### ◆ On-line Monitor Function

This function analyzes communication errors and communication procedures while displaying transmission and receiving data on the communication line on the screen.

### ◆ Simulation Function

Execute transmission/reception test as a communication partner of target device.

### ◆ Bit Error Rate Test

Evaluate the quality of data communication channel.

## Features

---

- High-Speed Communication. ( Max. 3.15Mbps : LE-3500XR , Max. 1.544Mbps : LE-2500XR )
- Touch panel with color LCD.
- Powerful monitor/analysis capabilities to various interfaces and multi-protocols.
- Program simulation as a standard function. [LE-3500XR ]
- It is extendable to 8 input analog data logger which is available for the high-precision measurement.
- Auto save function which records measured data into SD card or USB flash drive for a long time.
- Timing waveform measurement function which is useful to find timing troubles in a bit unit.
- Battery-powered, light-weight (Approx. 550g), and compact design for field application.
- Remote control by Wi-Fi.

## Optional Accessories

---

### ■ Interface Sub-Board B

By exchanging an interface sub-board for another, various protocols can be corresponded to and measured.

- OP-SB5GL Expansion kit for TTL/I2C/SPI
- OP-SB10N Expansion kit for RS-232C/ R S - 530 (RS-422/RS-485)
- OP-SB7XC Expansion kit for  
CAN/CAN FD/CXPI
- OP-SB7XL Expansion kit for  
CAN/CAN FD/LIN
- OP-SB1C Expansion kit for Current loop

### ■ Cable (with OP-SB10N)

- LE-25Y15 32GB SDHC card
- LE-25Y37 16GB SDHC card
- LE-25M34 8GB SDHC card

### ■ Analog pod

- OP-8AH High-speed measurement.  
Max.  $\pm$  60V.
- OP-8AT All inputs isolated. Thermometry.

### ■ SDHC card For preservation of measurement data and setting conditions

- SD-32GX 32GB SDHC card
- SD-16GX 16GB SDHC card
- SD-8GX 8GB SDHC card

### ■ PC software For remote measurement

- LE-PC300R PC link software(for Windows)
- LE-PC7XC PC link software for measuring  
In-vehicle communication  
(for Windows)  
\* This software needs OP-SB7XC or  
OP-SB7XL.

### ■ Firmware

- OP-FW10XR High-speed HDLC/SPI firmware  
[LE-3500XR ]
- OP-FW10XR high-speed HDLC/SPI communi-  
cation firmware [LE-3500XR ]

### ■ Dedicate printer

- SM4-31W Small mobile printer

## 1.4 Name of Each Part

### General

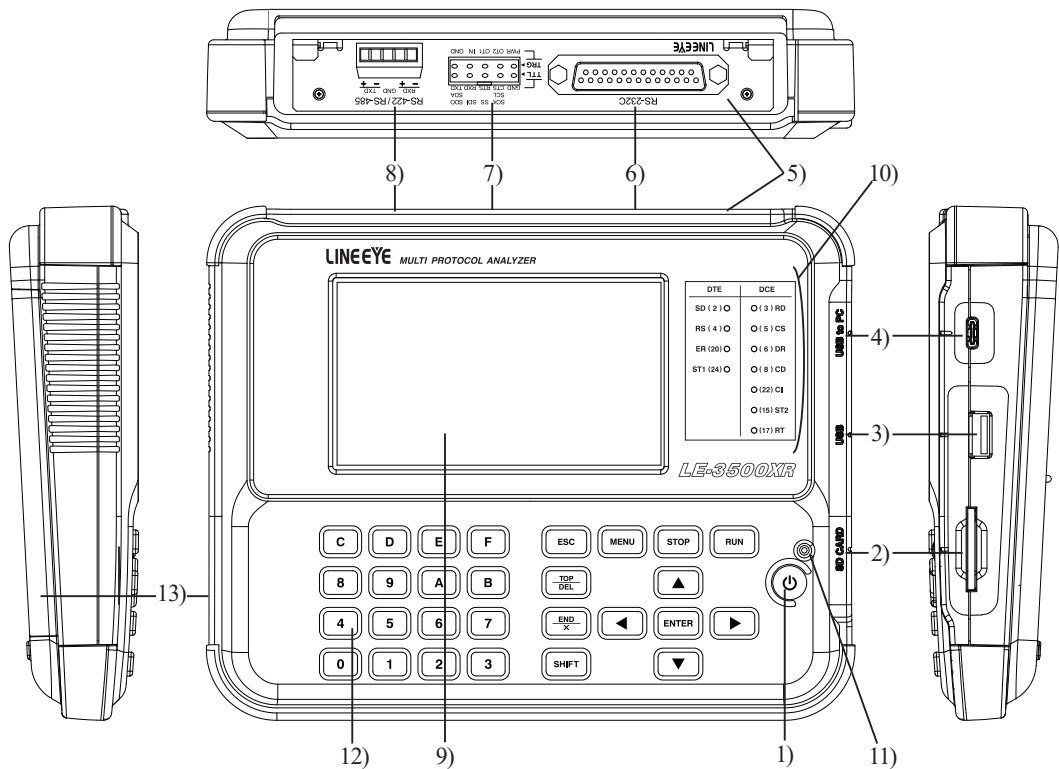

Name		Description
1)	Power Switch	Connection port for an USB memory or a dedicated printer
2)	SD Card Slot	The inlet for a SD/SDHC card .
3)	USB Host Port	Connection port for a USB flash drive.
4)	USB Device Port	USB Type-C connector connected to a PC or battery charger.
5)	Interface Sub-Board	An exchangeable interface sub-board.
6)	RS-232C Port	A measurement port for RS-232C (V.24).
7)	TTL, External Signal/O port	Measurement port for TTL. An I/O port for external signal. It can also be used as a connection port for an optional analog pod.
8)	RS-422/485 Port	Measurement port for RS-422/485.
9)	4.3 Inch Color Display	Capacitive touch panel.
10)	Line State LED	Indicating the logical status of signal lines on the target interface.
11)	Power LED	Lighting in green when using. Blinking in red when charging battery.
12)	Keypad	Entering commands and other operation.
13)	Battery Cover	Open/close when replacing the battery.

■ Power LED

Light in green during operation. Blink in red while it charges a battery.  
 Slow charge: Blink per 4 sec.  
 Normal charge: Blink per 1.5 sec.  
 Fast charge: Blink per 1 sec.

2.7 System Settings( Auto Power Off and Charging Battery)

■ Line state LED

Line state LEDs indicate the logical status (voltage level) of the input/output data on the signal lines connected to the measurement port in real time.

There are two groups: Signals for DTE device and for DCE device.

- Signal names of line state LED are conforming to JIS X 5101 standard.
- Enclosed No. is the pin number of RS-232C port.
- The correspondences between signal voltage and LEDs are below:



Voltage Level on the Signal Lines			Two-Color LED	
RS-232C	RS-422/485	TTL	Red	Green
+3V ≤ VM	VA-VB>+0.2V	VT<VIL	on	off
-3V<<VM<+3V	VA-VB<+0.05V	VIH<VT	off	off
VM<-3V			off	on

DTE	DCE
SD ( 2 ) ○	○ ( 3 ) RD
RS ( 4 ) ○	○ ( 5 ) CS
ER (20) ○	○ ( 6 ) DR
ST1 (24) ○	○ ( 8 ) CD
	○ (22) CI
	○ (15) ST2
	○ (17) RT

VM : Voltage Level of RS-232C  
 VA : Voltage Level on the RS-422/RS-485 [-Terminal]  
 VB : Voltage Level on the RS-422/RS-485 [+Terminal]  
 VT : TTL Level  
 VIL : Minimum of the threshold of input level H  
 VIH : Maximum of the threshold of input level L

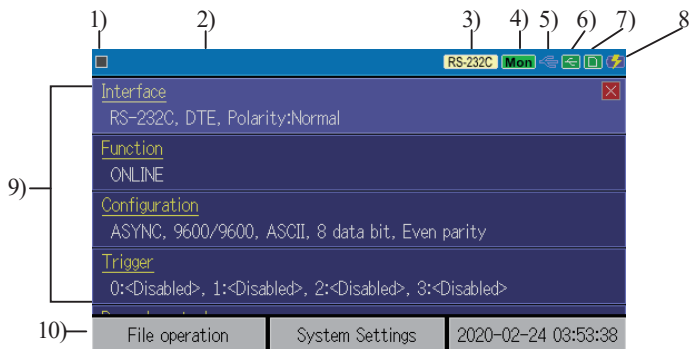
■ Data display window



1)	Measuring [  ], Pause [  ]
2)	Information of measured data
3)	Selected interface (selected measurement port).
4)	Selected function [Mon]: Monitoring, [DTE/DCE]: Simulating <sup>*1</sup> , BERT
5)	Status of USB device port (Bright: Connected)
6)	Status of USB host port (Bright: Connected) <sup>*2</sup>
7)	Status of SD card slot (Bright: Connected) <sup>*2</sup>
8)	Level of remained battery. [  ] indicates “USB bus power”
9)	Setting items or measured data. <sup>*3</sup>
10)	Touch panel for advanced settings. <sup>*3</sup>

\*1: [Sim] is displayed if it selects TTL port without defining DTE/DCE.

\*2: A red dot appears in the mark while the storage device is being accessed.







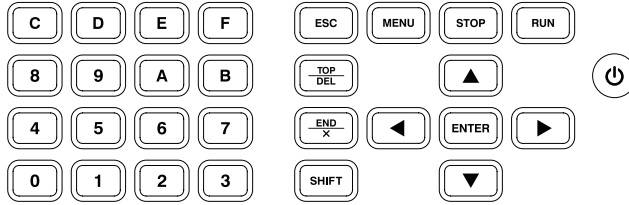



\*3: Touch control.

## Key operation

There is a keyboard to input data and operate commands.



### ■ Keys

Operations	Function
[  ]	Turn ON/OFF the power. Press it longer to turn off the power.
[RUN]	Start monitoring, measuring or testing operation.
[STOP]	Stop monitoring, measuring or testing operation.
[MENU]	Return to the top menu.
[ESC]	Return to the previous display. Return to the measured data from setting display. Stop renewing data display while measuring.
[  ], [  ]	Scroll one data line. Move the cursor on the condition setting.
[  ], [  ]	Scroll one character of data. Change the setting on the condition setting.
[ENTER]	Apply selected settings.
[0]~[F]	Enter numerical values. Select the data send table number.
[TOP/DEL]	Jump to the top of data. Delete the entry indicated by the cursor.
[END/X]	Jump to the end of the screen. Enter the data of “Don't Care”.
[SHIFT]	Press to use the expanded alternate function of each key.
SHIFT+[MENU]	Displays the operation menu while displaying measurement data
SHIFT+[ESC]	Save a screenshot or print it by a printer <sup>*1</sup>
SHIFT+[RUN]	Brighter the LCD back light.
SHIFT+[STOP]	Darker the LCD back light.
SHIFT+[1]+[  ]	Switch to analog measurement firmware <sup>*2</sup>
SHIFT+[3]+[  ]	Switch to high-speed communication measurement firmware <sup>*2</sup>
SHIFT+[0]+[  ]	Switch to normal communication measurement firmware
[ENTER]+[DEL]+[  ]	Initialize settings. Clear all.
SHIFT+[STOP]+[  ]	Start the firmware loader.

\* [X]+[Y] indicates the operation of pressing [X] and [Y] together at the same time.

\* 1: Specify at the “Screen shot destination” in the Display/Print tab of the system settings.

\* 2: Requires optional accessory.

 Shortcut keys are available from [MENU] and [0]~[F].

## 11.3 Shortcut Keys

### ■ Touch panel

Following operation is available

Tap	Tap the screen once to select the setting etc.
Double tap	Tap the screen twice to select and execute the setting.
Swipe	Touch and slide the finger to scroll data.
Drag	Touch and hold the finger then move it till the target place to select data.

# 1.5 Power Supply and Battery

This analyzer drives by a battery and bus power from a USB port.

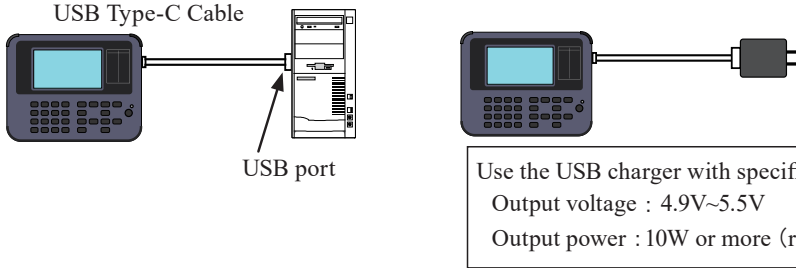

## ■ Charge the Battery

Lithium ion battery is charged while analyzer runs by the USB bus power.

Factory setting is “Normal charge” and charging time is following.

While analyzer is turned off : Take about 6 hours for full charge.

While analyzer is turned on : Auxiliary charging. Take much time for full charge.

Change the charging type from system menu to save battery life or to charge faster.

2.7 System Settings( Auto Power Off and Charging Battery)

- Before using the product for the first time, charge the battery first.
- Charge the battery under the condition of 5 ~40 °C. If the temperature is below 5°C, it cannot charge the battery.
- It cannot charge the battery full if the USB charger or USB bus power is below 4.8V.
- Charge the battery full before putting it aside for a long time. In this case, charge the battery once in a half year.

## ■ Replace the Battery

If the analyzer cannot drive by the battery any longer, or the running time after charging is extremely short, replace the battery. Remove the battery cover and replace the battery.

- As the battery is consumables, it needs the fee for replacement even during the warranty period.
- Please recycle the replaced old batteries properly in accordance with the local law.

11.7 Warranty and After service

To replace the battery, purchase LINEEYE Lithium ion battery (model: P-26LS1), and do not use any other.

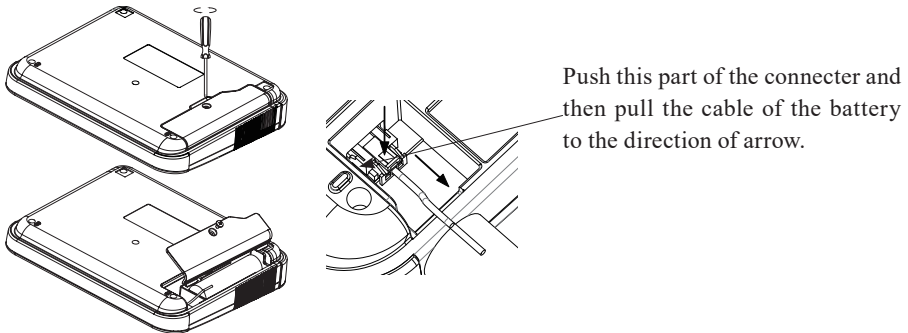

- Battery is necessary for saving data in the storage device during the power shortage. Insert the battery all the time.

## ■ Lithium primary battery

Measured data in the SRAM, setting data, clock IC are saved by the Lithium primary battery for about 5 years even though analyzer turns off the power.

- If “Initialized” is displayed at the opening screen every time, it is necessary to exchange the Lithium primary battery. Please contact LINEEYE or LINEEYE distributor.

# Chapter 2 Basic Operation and Set-up

## 2.1 Power Source ON (Opening Screen)

### Power Source ON

Press [  ] to turn on the power of analyzer. The opening screen will be displayed after the self-check. At the opening screen, it is able to confirm the firmware version, language and current time.

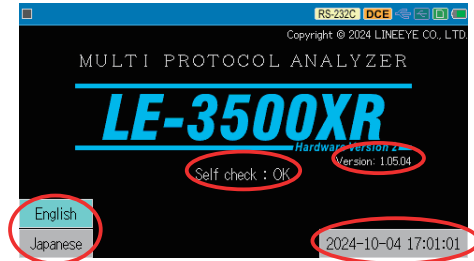

- ☰ If “Self check NG” is displayed at the opening screen, please contact LINEEYE distributors or LINEEYE directly. (“Self check OK” should be displayed)
- ☰ If <## Firmware loader ##> is displayed, insert the interface board correctly. Before using the optional interface board, write the corresponding firmware to the analyzer.

 11.5 Firmware Update

### Language (English or Japanese)

Select the language (English or Japanese) from the left bottom of opening screen.

The screen will automatically change to the next page after some seconds. To select the language again, reboot the analyzer.

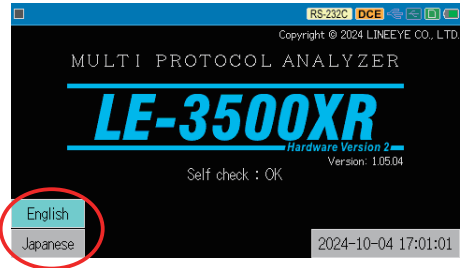

### Time and Date Setting

Press displayed time and date on the right bottom of opening screen.

- 1) Current time and date are displayed in the first line on the screen.
- 2) Move the cursor by [◀],[▶] or touch the place needed to be changed.
- 3) Set the time and date by [0] to [9] keys.
- 4) Set the time in order of Hr(24hour)/Min/Sec, and date in order of Yr/Mon/Day.
- 5) Press [ENTER] or touch “Apply” to apply the setting, or press [ESC] or [MENU] to cancel.

- ☰ Information of time and date is used for time stamp and Auto start/stop. Make sure to input the current time and date precisely.

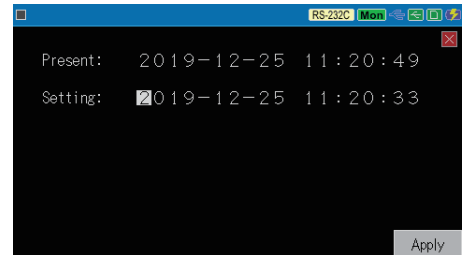

### Power Source OFF

Press and hold the power switch for about 2 seconds to turn off the power of analyzer. The setting data and captured data are saved in the inner memory of analyzer for about 512K byte. To save all data, use the SD card or USB flash drive.

 6.6 Auto Backup Function

 Chapter 8 Save and Load of the Data

## 2.2 Top Menu

Press [MENU] to set the initial settings. Swipe the screen to set all settings.

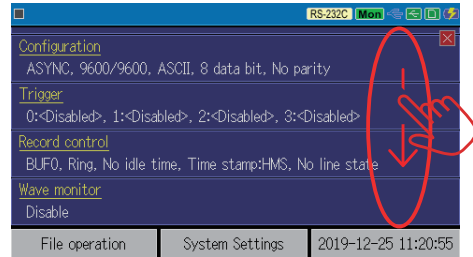
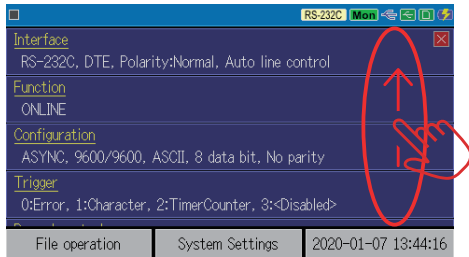

Touch the setting item, or press [ENTER] after selecting the item by [ ▲ ], [ ▼ ].

“File operation”, “System settings” and “Current time” on the bottom of screen are also needed to be set.



2.7 System Menu



Chapter 8 Save and Load of the Data

## 2.3 Measurement Port

Press [MENU] then touch “Interface”.

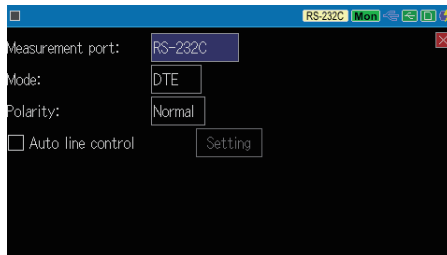

Select the measurement port of target device.

- Also it is able to select the item by [ ▲ ], [ ▼ ] and change the setting by [ ◀ ], [ ▶ ].
- Setting items are different for optional expansion boards.

### ■ Measurement Port

Select “RS-232C” to measure RS-232C, or “RS-422/485” to measure RS-422/485. Select TTL and its voltage to measure TTL interface.

- Selected interface will be displayed on the upper right of screen.

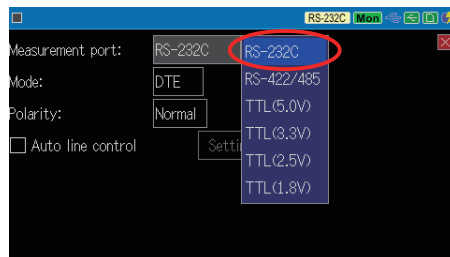

○ For RS-232C and RS-422/485

■ Mode

Select DTE or DCE mode for Simulation/BERT function.  
It is used for changing the input/output status for selected port during the measurement.  
If it is a Monitor function, or not running (stopping) Simulation/BERT function, all signals of measurement port become input status.

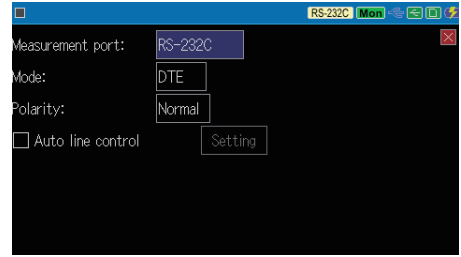

- 📖 In general, PC and data terminal equipment are “DTE”, and modems and terminal adapters are “DCE”.
- 📖 When using the simulation function or BERT function, the selected DTE/DCE is displayed at the top of the screen. However, when TTL port is selected, as there is no distinction of DTE/DCE, thus "Sim" is displayed. When using the monitor function, "Mon" is displayed regardless of this setting.

■ Polarity

Select “Normal”. If selecting “Invert”, all signals are inverted.

■ Auto line control (for RS-232C only)

Set ON/OFF of auto line control and timing of data transmission for simulation.

📖 4.3 Auto Line Control

■ Driver control (for RS-422/485 only)

Select ON/OFF of driver IC control for simulation.

📖 4.2 RS-422/485 Driver Control

■ Half-duplex simulation (for RS-422/485 only)

If you check this box when performing a half-duplex simulation, the data sent from this unit and other received data will be recorded separately on the TXD and RXD sides.  
If you do a full-duplex simulation, do not check this box.

○ For TTL

■ Output type

Select the output type of TTL signals for simulation.

- “Pull-up” : With pull-up resistor of open collector.
- “No pull-up” : Without pull-up resistor of open collector.
- “CMOS” : CMOS push-pull output.

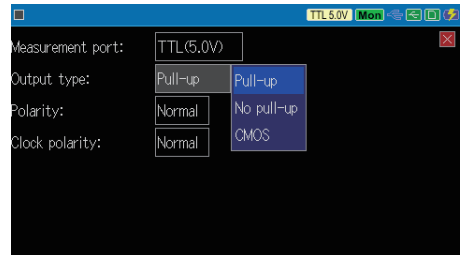

■ Polarity

Select “Normal”. If selecting “Invert”, all signals are inverted.

■ Clock polarity

Select the polarity of clock signal. If selecting “Invert”, all signals are inverted.

○ For “OP-SB10N” sub-board.

Setting items are different for optional sub-board.

■ V.35 mode

Select “ON” only to measure V.35 interface by OP-SB10N and LE-25M34 (optional cable).

📖 11.2 Signal Definition of the Measurement Ports

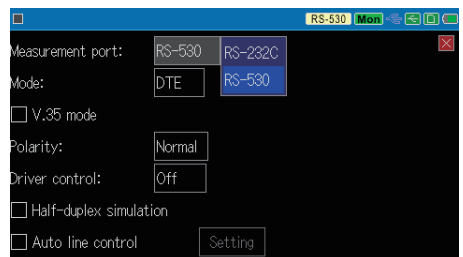

- 📖 For other interface expansion boards, refer to the instruction manual of each board.
- 📖 Even if you change the “Polarity” and “Clock polarity”, the timing waveform display is not reversed.

📖 6.3 Timing Waveform Measurement Function

## 2.4 Measurement Function

Press [Menu], then touch“Function”.

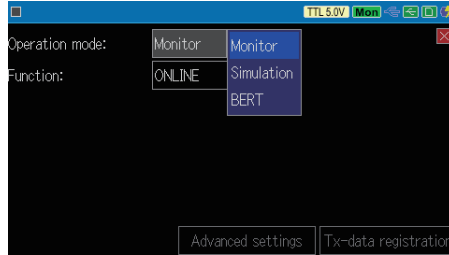

Select the operation mode and function. Touch “Advanced settings” for addition settings. For Simulation function, touch“Tx-data registration” to register transmission data.

### □ Monitor

The analyzer monitors transmission/reception data at real time, and analyzes data and errors.

Select “ONLINE” for general use.



Chapter 3 Monitor Function

☰ “Mon” is displayed on the upper right of screen.

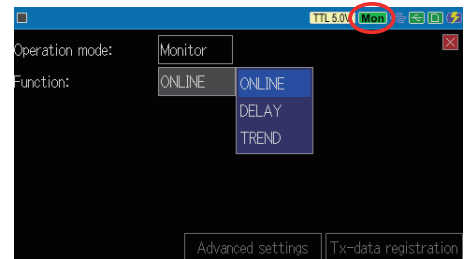

### □ Simulation

The analyzer becomes the counterpart for developing devices and transmits/receives data.

For simple transmission test, select“MANUAL”.



Chapter 4 Simulation Function

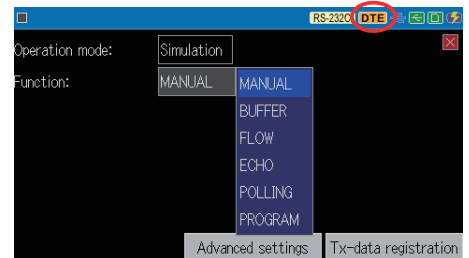

### □ BERT (Bit Error Rate Test)

The analyzer sends the test pattern and compares the received data with the test pattern. This is useful to evaluate quality of data communication line.



Chapter 5 BERT Function

☰ When the simulation function or BERT function is selected, "DTE" or "DCE" or "Sim" is displayed at the top of the screen depending on the interface mode setting.

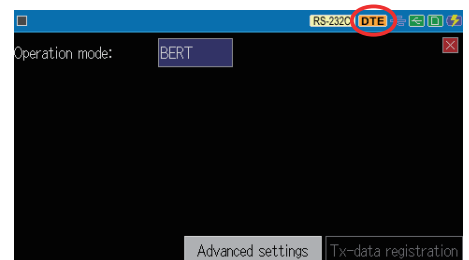

## 2.5 Communication Condition

Press [MENU], then touch “Configuration”.

Set the communication conditions of target devices.

Touch and select setting items, or input by [0] - [F] and [X] keys.

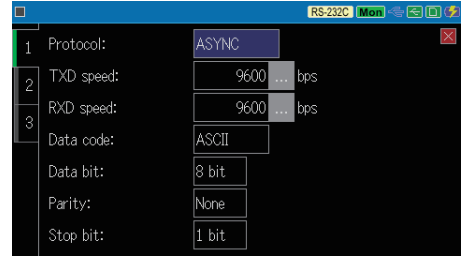

- To set all settings, move the setting items by [ ▲ ], [ ▼ ] keys, or touch another tab.
- It is able to select the settings by [ ◀ ], [ ▶ ] keys.
- Auto configuration is available.

### 6.4 Auto Configuration Function

## Protocol

Touch “Protocol” and select the protocol of target devices. ASYNC is the widely used communication.



### ■ Protocol

Selection	Protocol	Description
ASYNC	Asynchronous	Communication which uses the start and stop bit. Ex.) PC COM port, UART communication.
SYNC·BSC	Character-SYNC	Communication which uses 1 or 2 bytes of SYNC characters. Ex.) BSC, JCA procedure etc.
HDLC·SDLC	Flag-SYNC	Communication which uses the flag bit patterns (7Eh). Ex.) HDLC, SDLC, X.25, LAPD
ASYNC-PPP	PPP (ASYNC typed)	Asynchronous which uses flag characters (7Eh). Ex.) ASYNC-PPP communication used for WAN etc.
MODBUS	MODBUS(ASCII/RTU)	Communication which is widely used for FA devices. [LE-3500XR only]
I2C	I2C	Communication which uses 2 lines (SDA and SCL) at TTL level.
SPI	SPI	Communication which uses 3 (or 4) lines at TTL level.
Burst	Clock-Sync	Communication which has the Sync-clock only when transmitting/receiving data.

## Communication Speed

Set the communication speed of target devices. For simulation function, it is able to check the tolerance of target device by setting the different speed on purpose.

### TXD speed

Set the communication speed of transmission line. After setting this, RXD speed is automatically set.

### RXD speed

Set the communication speed of receiving line.

### Speed

Set the communication speed for Modbus, I2C, SPI and Burst.

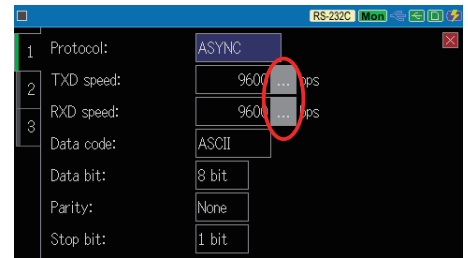

Touch and pre-set speeds (widely used) are displayed. Swipe the screen to display more.

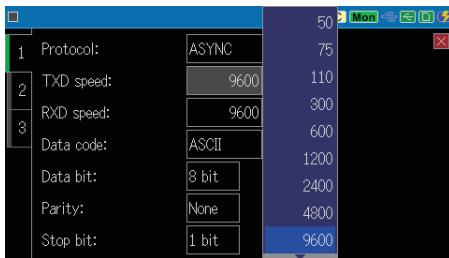

## Arbitrary Speed

Set any arbitrary speed by [0] - [9] and alphabet keys. [D] represents “kilo”, [E] represents “mega” and [C] is for inserting “comma”: “M”, “k”, and “.” are also appeared on the right bottom of screen.

Exp.: To set “945.6kbps”, input [9] [4] [5] [C] [6] [D].

Press [◀], [▶] to increase/decrease the speed.

A margin can be evaluated at staggered communication speed on purpose because appointed communication speed can be set. (simulation function)

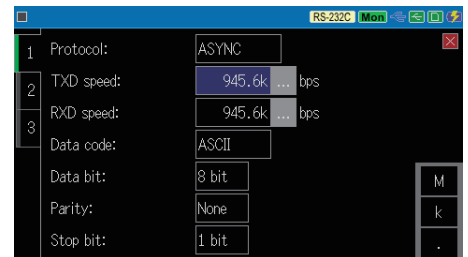

Each protocol has different settings.

○ ASYNC

■ Data code

Select a data code from ASCII, EBCDIC, EBCDIK, JIS, EBCD, Transcode, IPARS, Baudot and HEX.

For some data codes, it changes the character by SHIFT control.

“JIS7” and “JIS8” are automatically changed by setting of “Data bit”.

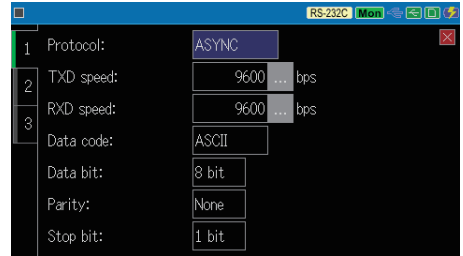

■ Data bit

Set a data bit length. Only the bit length allowed for each data code can be set.

10.4 Data Code Chart

■ Parity

Set a parity bit and a MP (multi-processor) bit.

MP is the 1 bit of transmission information adding after data bit.

Parity bit is always 1 for “Mark” and 0 for “Space”.

■ Stop bit

Set a stop bit length. Stop bit is added to transmissions data during simulation. (For received data, stop bit is always 1 bit.)

■ BCC

Set a block check code. If “None” is set, block check is not executed.

Selection items of BCC are changed by total bit of data bit and parity bit.

10.1 Calculation of the Block Check

■ Begin code

Set a calculation start code for block check in HEX. As a factory setting, “01h, 02h” is already set.

Higher bits than a bit length set on “Data bit” are invalid.

■ End code

Set a calculation end code for block check in HEX. As a factory setting, “03h, 17h” is already set.

Higher bits than a bit length set on “Data bit” are invalid.

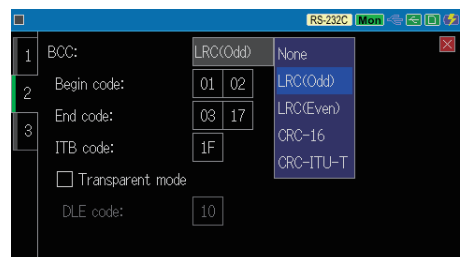

■ ITB code

Set an ITB code to calculate block check. As a factory setting, “1Fh” is already set.

Higher bits than a bit length set on “Data bit” are invalid.

■ Transparent mode

Select on/off of transparent mode during calculation of block check.

■ DLE code

Set a DLE code in HEX for transparent mode. As a factory setting, “10h” is already set.

■ Bit sequence

Set a bit sequence. For general protocols, select “LSB first”.

< Example of LSB first >

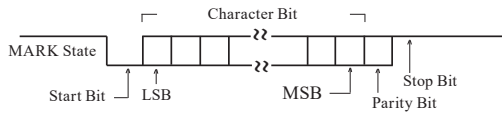

< Example of MSB first >

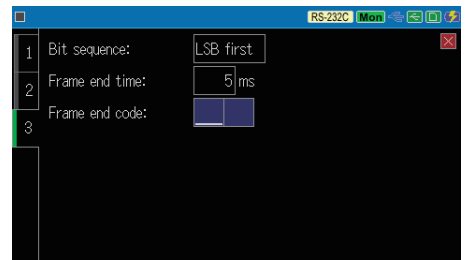
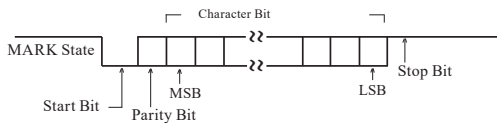

■ Frame end time

Set the time of non-communication state which is judged as a frame end at between 1ms and 100ms.

Initial value is 5ms.

- 📖 This setting is necessary to record time stamp.
- 📖 Set the frame end time to be smaller than idle time.

■ Frame end code

Set a frame end code (1 or 2 characters) in HEX.

- 📖 Initial setting is “blank”. If setting nothing in here, frame end is judged by “Frame end time”.

○ SYNC • BSC (Character SYNC)

■ Data code

Same as ASYNC.

■ Data bit

Set a data bit length. Only the bit length allowed for each data code can be set.

Total bit of data bit and parity should be 6 or 8.

📖 10.4 Data Code Chart

■ Parity

Set a parity bit.

■ Clock

Select a SYNC-clock to receive/transmit communication data. Select “AR” if the SYNC-clock is uncertain or using the RS-422/485 port which has no clock line.

📖 10.2 Send/Receive Clock

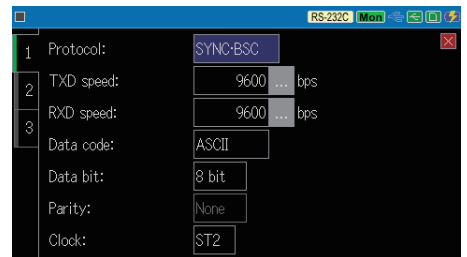

■ SYNC code

Set a SYNC-character (1 or 2) in HEX. The initial value is “16h, 16h” which is often used in ASCII and JIS. (“32h, 32h” for EBCDIC and EBCDIK)

Higher bits than a bit length set on “Data bit” are invalid. If setting the parity bit, character with parity is the target to establish synchronization. For example, if setting “Data bit: 7”; “Parity: even”, “SYNC code: 1616 or 9696”, synchronization is established when receiving “96h, 96h”. (not receiving “16h, 16h”)

■ Reset code

Set a reset code in HEX. The initial value “FFh” and it is not necessary to change the values in most of the cases.

Higher bits than a bit length set on “Data code” are invalid.

■ Suppress code

Set a suppress code in HEX. When codes set in this section are monitored continuously, the second byte and after ones are not recorded in the capture buffer.

■ Bit sequence

Set a bit sequence. For general protocols, select “LSB first”.

■ Format

Select an encoding type from “NRZ” or “NRZI”. The initial setting is “NRZ”.

■ BCC

Same as ASYNC.

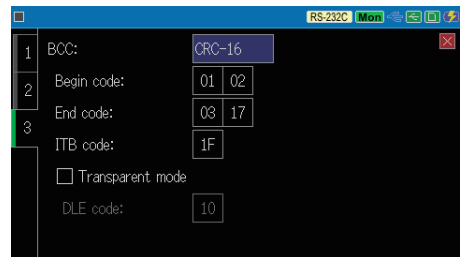
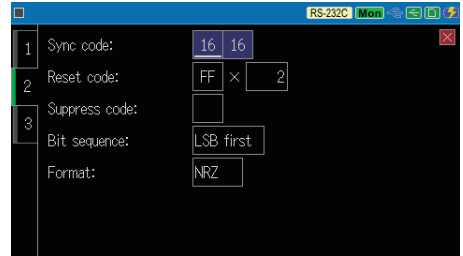

○ HDLC • SDLC

■ Data code

Select a data code from ASCII, EBCDIC, EBCDIK, JIS and HEX.

■ FCS

Select a frame checking sequence (error check) type from “None”, “FCS-16” or “FCS-32”.

10.1 Calculation of the Block Check

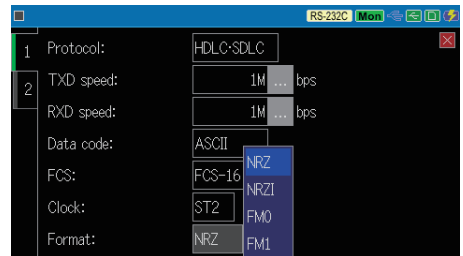

■ Clock

Select a SYNC-clock to receive/transmit communication data. Select “AR” if the SYNC-clock is uncertain or using the RS-422/485 port which has no clock line.

10.2 Send/Receive Clock

■ Format

Select an encoding type from “NRZ”, “NRZI”, “FM0” or “FM1”. The initial setting is “NRZ”.

NRZI is also used if the clock is “AR”.

■ TXD address of address filter (pass)

Set a frame address (8 bits after a flag) on the TXD(SD) side in HEX to receive related frames.

To receive all frames, set “\* (don’t care)”. Initial setting is “ \* ”.

■ RXD address of address filter (pass)

Set a frame address (8 bits after a flag) on the RXD(RD) side in HEX to receive related frames.

To receive all frames, set “\* (don’t care)”. Initial setting is “ \* ”.

📖 The address filter has no effect on the data sent by the analyzer in the simulation function.



■ Translation protocol (initial value) Frame

Set a translation specification of frame level. The initial value is “X.25”.

■ Translation protocol (initial value) Packet

Set a translation specification of packet level. The initial value is “X.25”.

📖 10.5 Translation Display Specification

■ Idle mode for simulation

Select an idle state (“Mark” or “Flag”) between frames.

■ Leading flag for simulation

Set the number of transmission starting flags from 1 to 10. The initial value is 1.

📖 It is necessary to have some frags to adjust the position of received clock by the data.

○ ASYNC-PPP

■ Data code

Select a data code from ASCII, EBCDIC, EBCDIK, JIS and HEX.

📖 When selecting “ASYNC-PPP”, it automatically sets “Data bit: 8”, “Parity: none” and “Stop bit: 1”.

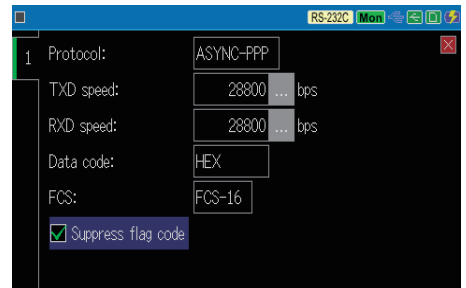

■ FCS

Select a frame checking sequence (error check) type from “None”, “FCS-16” or “FCS-32”.

📖 10.1 Calculation of the Block Check

■ Suppress flag code

When the frag character (7Eh) is monitored continuously, the second byte and after ones are not recorded in the capture buffer.

○ MODBUS

■ Transmission mode

Select a transmission mode from “ASCII” or “RTU”.

RTU: If there is a frame with 3.5 characters or more of silent interval (non-communication time), the last second byte is recognized as CRC error check code.

Data structure of ASCII: Begin code (“: (3Ah)”), + Data (“0 (30h)” ~ “9 (39h)”, “A (41h)”~ “F (46h)”), + End code (“CR”, “LF (0Dh, 0Ah)”).

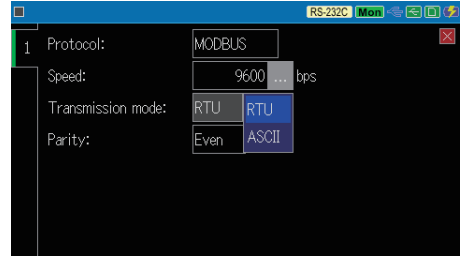

■ Parity

Set a parity bit.

For Modbus protocol, it automatically set to 10 bit ASYNC communication. (Data bit (8), parity (0 or 1) and stop bit (1 or 2).

○ I2C

■ Data code

Select a data code from ASCII, EBCDIC, EBCDIK, JIS, and HEX.

Select “HEX” for general use. (initial setting is HEX)



■ Simulation mode

Select “master” or “slave” for I2C simulation.

■ Address bits

Set the number of address bit of analyzer during slave simulation.

■ Slave address

Set the address of analyzer in HEX during slave simulation.

The relationship between inputted data and address is following.

(Exp.) Input 123 (0100100011b)

7-bit address is “0010001”

10-bit address is “0100100011”

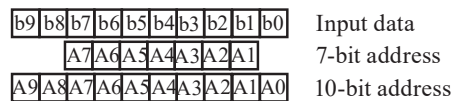

For I2C protocol, select “TTL(5.0V)~TTL(1.8V)” from “Interface”->“Measurement port”, and select “No pull-up” or “Pull-up” (target device does not have a pull-up resistor) for “Output type”.

○ SPI

■ Data code

Select a data code from ASCII, EBCDIC, EBCDIK, JIS, and HEX.

Select “HEX” for general use. (initial setting is HEX)

■ Clock polarity

Set the polarity of SPI clock.

■ Clock phase

Set a topology of SPI clock.

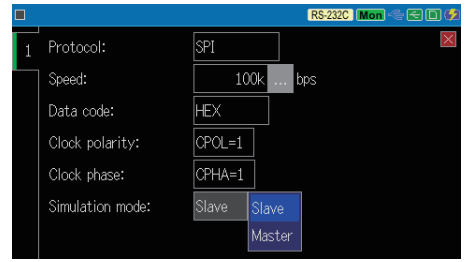

< Timing of SPI clock and data >

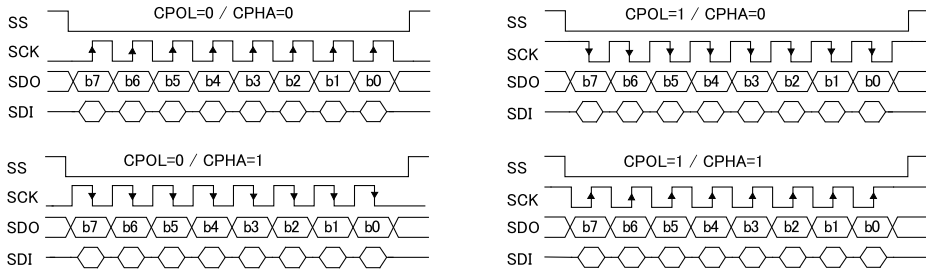

■ Simulation mode

Select “master” or “slave” for SPI simulation. According to this setting, direction of SS signal and SCK signal will be changed.

2.8 Connect to the Target Devices

For SPI protocol, select “TTL(5.0V) ~TTL(1.8V)” from “Interface”->“Measurement port” and select “Output type: CMOS”.

○ Burst

■ Data code

Select a data code from ASCII, EBCDIC, EBCDIK, JIS, and HEX.

■ Data bit

Set a data bit length. (7 or 8)

■ Parity

Set a parity bit.

■ Bit sequence

Select a bit sequence.

■ Frame end time

Set the time (1 ~100ms) of non-communication state which is judged as a frame end.

The initial value is 5ms.

This setting is valid only for monitoring of Burst protocol.

For Burst protocol, select “TTL(5.0V) ~TTL(1.8V)” from “Interface”->“Measurement port”.

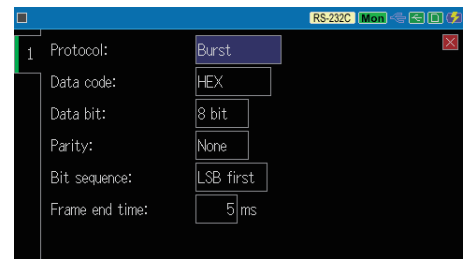

## 2.6 Record Control

Press [MENU], then touch “Record control” to set the recording conditions of measured data.

Set an idle time and time stamp at “Additional info”. And, set the buffering area at “Capture buffer”.

Touch each tab or press[SHIFT]+[▶]or [SHIFT]+[◀].

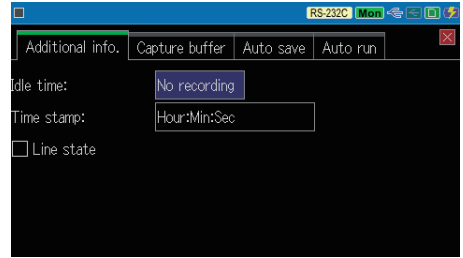

### Idle time

#### ■ Idle time

The time, when SD/RD keep non-communication status and signal lines keep changeless status, is recorded. Set on/off of recording idle time and its resolution.

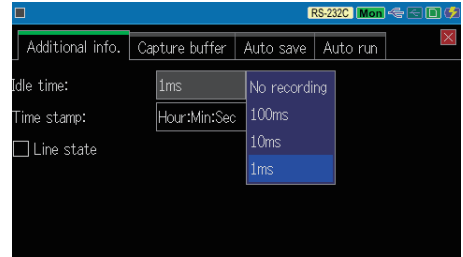

### Time stamp

#### ■ Time stamp

The time, when the head of character of each frame running through the communication channel is received, is recorded in the capture buffer and displayed. Set on/off of recording time stamp and its resolution.

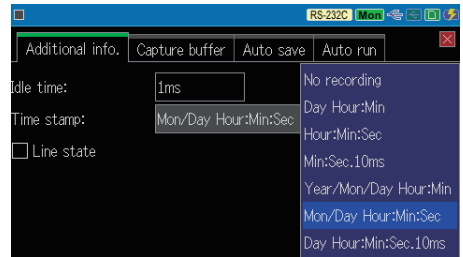

### Line state

#### ■ Line state

Mark on the box to record the line states (RTS, CTS, DCD, DTR, DSR, RI, TRG) along with the measured data. If it sets the idle time, idle time of the line states will be recorded as well.

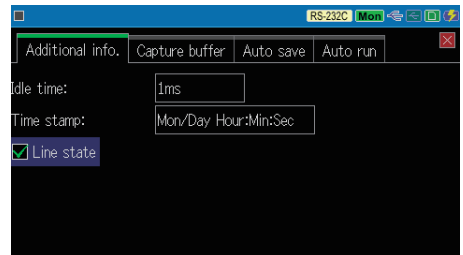

## Dividing a Capture Buffer

Touch the tab of “Capture Buffer” and set the capture memory setting of recorded data.

### ■ Recording area

Select whether a memory is used as one capture buffer or two capture buffers.

- 4 or 8 bytes is consumed from memory to record one unit of measured data and time stamp etc.

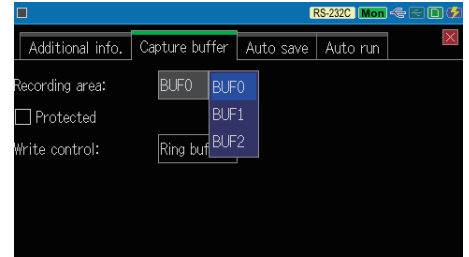

BUF 0 : The whole buffer can be used as one capture buffer.

BUF 1/2 : The capture buffer is divided into two (BUF1 and BUF2) and they are used to measure separate data. It is useful to compare measured data or simulate measured data in BUFFER mode.

 Chapter 4 Simulation Function

### ■ Protected

Mark on the box to prevent data recorded in the buffer memory from being inadvertently overwritten. A pop-up message will be displayed when starting measurement or reading data from files.

- Do not mark on the box when it uses Auto-save function.

## Buffer Full Stop

### ■ Write Control

Select the recording type of capture memory.

Ring buffer : Data will be overwritten from the beginning of capture buffer to record data endlessly.

Full stop : The operation will stop as soon as the memory capacity becomes full.

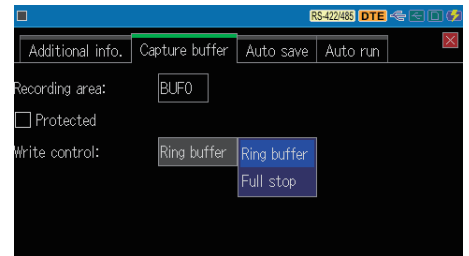

## 2.7 System Menu

Press [MENU], then touch “System settings”. Touch the tab or press[SHIFT]+[▶]or[SHIFT]+[◀]

## Backlight and Saving Screen Shot

### ■ Backlight brightness

Adjust the brightness of backlight by [◀]or[▶].

The brighter the backlight, the shorter the running time (higher consumption of current).

- Also, it can adjust the brightness by pressing [SHIFT]+[RUN] (brighter), or [SHIFT]+[STOP] (darker).

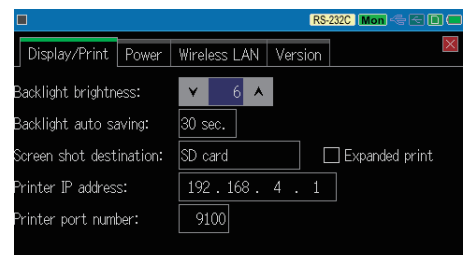

■ Backlight auto saving

If there is no key operation during the set time, the backlight will be automatically darker to save power consumption. Set “Off” to invalid this setting.

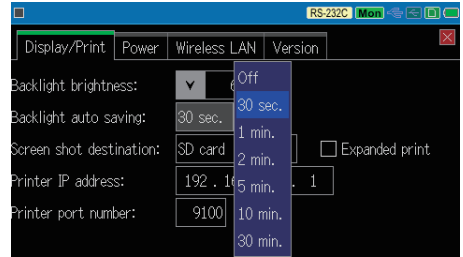

■ Screenshot output destination

Set the output destination of the screenshot (that can be taken by pressing [ESC] while pressing [Shift]). If you select “SD card” or “USB Memory/Printer”, the selected one will be a priority device when multiple devices are connected. When selecting the “wireless LAN printer”, it is limited to the printer specified by the next “printer IP address” and “printer port number”.

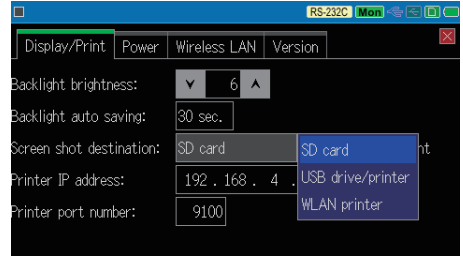

📖 When specifying storage devices, it is saved in the SCRNSHOT folder.

📖 If you check the “Expanded print”, it will be enlarged and printed.

📖 When selecting the “Wireless LAN Printer”, you need to set the wireless LAN setting in advance.

📖 8.3 Text conversion and printing function of measurement data

## 📖 Auto Power Off and Charging Battery

Touch the tab of “Power”.

■ Auto Power Off

Turn off the power if there is no key operation during the set time. Initial setting is “Off”.

📖 While measuring data, auto-power off function will not work.

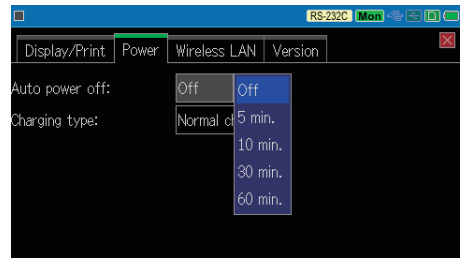

■ Charging type

Select the charging type of Lithium ion battery. Change the setting while the analyzer uses the USB bus power.

Slow charge : It takes a long time until full charge. Charging current is 100mA or less.

Normal charge : It takes about 6 hours until full charge if analyzer is turned off. If analyzer is turned on, it becomes “Slow charge”.

Fast charge : It takes about 3.5 hours until full charge if analyzer is turned off. It takes about 6 hours if analyzer is turned on.

📖 Select “Slow charge” if using the analyzer with bus power.

📖 Select “Fast charge” only when charging the battery by USB battery charger. Do not select it if charging by the USB bus power from the PC, because it may exceed the ability of supply power for USB port.

📖 LED lights are corresponded to the type of charging battery.

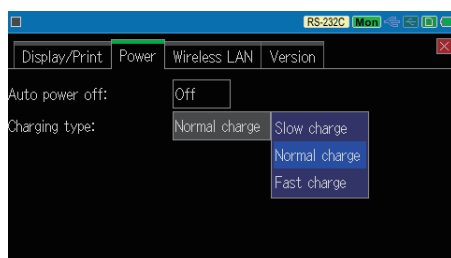

📖 1.4 Name of Each Part

Touch the tab of “Wireless LAN”.

At the time of purchase, the built-in Wi-Fi module is disabled and no Wi-Fi radio waves are output. When connecting to a PC or dedicated printer via Wi-Fi, you need to enable the Wi-Fi module by touching “Setting change”.

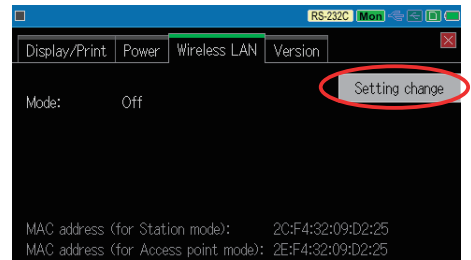

■ Wireless LAN Mode

Touch “Wireless LAN mode” and select “Station” or “Access point” for wireless LAN module.

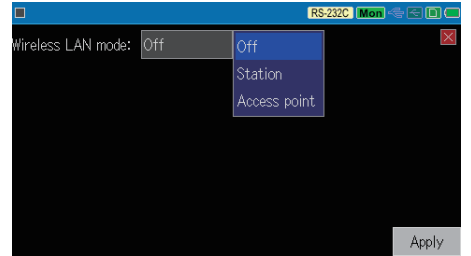

Off                    The inner Wi-Fi module is invalid.

Station                The analyzer connects to the network via wireless access point.

Access Point        The analyzer itself becomes the wireless access point, and connects to the PC one by one.

Touch “Apply” to apply settings.

○ Station Mode

■ SSID

Set the SSID of the Wi-Fi access point.

 When connecting to a computer via Wi-Fi, set the SSID of the Wi-Fi router to which the PC is connected.

 When connecting a dedicated printer via WiFi, set the SSID of the Wi-Fi router or the SSID of the dedicated printer.

 8.3 Text conversion and printing function of measurement data

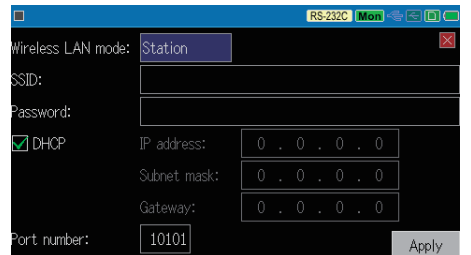

■ Password

Security key (encryption key) of wireless access point.

 Input characters are changed to “●” for security purpose.

■ DHCP

Mark on the box when using the network which provides the IP address automatically. Remove the mark if using the specific IP address.

■ IP address

IP address of the analyzer.

■ Subnet mask

Subnet mask of the analyzer.

■ Gateway

Default gateway.

Before changing the IP address and DHCP, try to confirm with the person who is in charge of the network.

■ Port number

Set the port number of analyzer. The initial value is “10101”.

Touch “Apply” at the end. If the analyzer can connect to the wireless access point successfully, following display will be appeared.

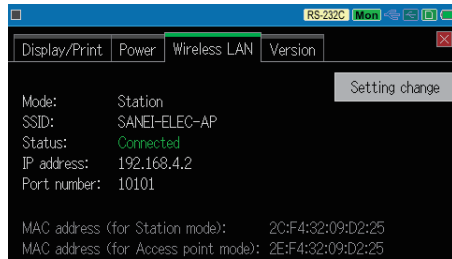

☰ If “Access point not found” is appeared, replace the analyzer nearby the access point, or check the SSID and password.

○ Access point mode

■ SSID

The initial value is “LE\_XXXXXXXX”. (XXXXXXXX is the serial number)

If using more than one analyzers, each one should have different SSID.

■ Password

Security key (encryption key) of wireless access point.

The initial value is “@XXXXXXXX#”. (XXXXXXXX is the serial number)

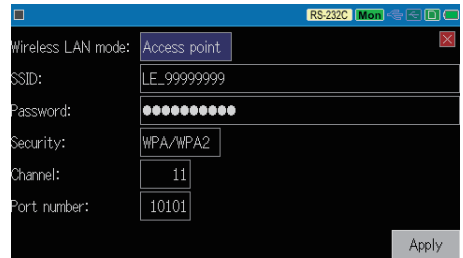

■ Security

Select the security protocol from OPEN, WPA, WPA2 or WPA/WPA2.

☰ If selecting “OPEN”, the password will be invalid.

■ Channel

Select the wireless channel (1~13). If selected channel is crowded, try to use another channel.

■ Port number

Set the port number of analyzer. The initial value is “10101”. Touch “Apply” at the end.

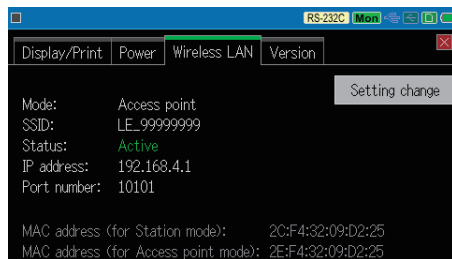

For access point mode, the IP address of analyzer is “192.168.4.1” and this cannot be changed. Thus, change the IP address of the target device (PC etc.) to the one within the same network group (exp. 192.0.168.4.2), or change the setting of the DHCP server to receive the IP address from analyzer.

## 2.8 Connect to the Target Devices

### Connect to RS-232

To measure RS-232C, select “RS-232C” from “Interface” -> “Measurement port”.

 2.3 Measurement Port

#### ■ For monitoring

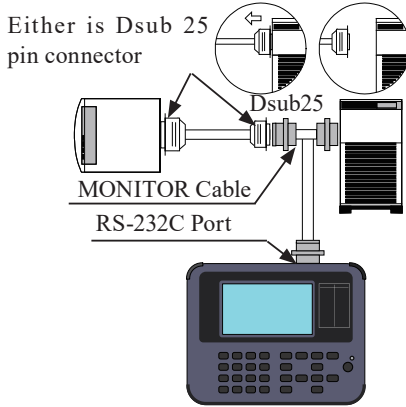

If the connector of either target device is Dsub 25 pin, use attached DSUB 25 pin monitor cable (LE-25M1) to connect to the analyzer.

[ Connection of LE-25M1 ] ( ) is the pin number .

Dsub25pin male Dsub25pin male Dsub25pin female

(1) -----	(1) -----	(1)
(2) -----	(2) -----	(2)
(3) -----	(3) -----	(3)
(4) -----	(4) -----	(4)
.		
· (connected to the same numerical pin)		
.		
(24) -----	(24) -----	(24)
(25) -----	(25) -----	(25)

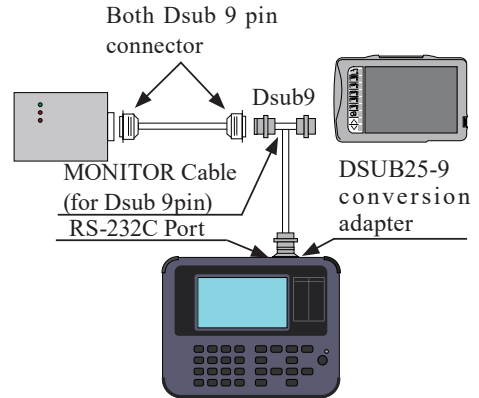

If the connectors of both target devices are Dsub 9 pin, use attached DSUB 9 pin branch cable (LE-009M2) and DSUB 25-9 conversion adapter to connect to the analyzer.

[ Connection of LE-009M2 and DSUB25-9 adapter ]

( ) is the pin number.

DSUB25-9 adapter		LE-009M2	
Dsub25pin male	Dsub9pin male female	Dsub9pin female	Dsub9pin male
(8) -----	(1) -----	(1) -----	(1)
(3) -----	(2) -----	(2) -----	(2)
(2) -----	(3) -----	(3) -----	(3)
(20) -----	(4) -----	(4) -----	(4)
(7) -----	(5) -----	(5) -----	(5)
(6) -----	(6) -----	(6) -----	(6)
(4) -----	(7) -----	(7) -----	(7)
(5) -----	(8) -----	(8) -----	(8)
(22) -----	(9) -----	(9) -----	(9)

#### ■ For Simulation

Connect analyzer and target device one by one. Connect as following, concerning the specification of target device (DTE/DCE) and RS-232C cable.

DTE device	----	Straight cable	----	Analyzer (DCE setting)
DCE device	----	Straight cable	----	Analyzer (DTE setting)
DTE device	----	Cross cable	----	Analyzer (DTE setting)
DCE device	----	Cross cable	----	Analyzer (DCE setting)

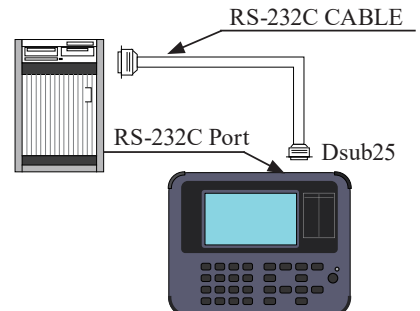

To measure RS-422/485, set “Measurement port: RS-422/485” at “Interface” setting.

If the RS-422/485 connector (or terminal block) of target device uses unique specification, check the signal assignment carefully. And then connect to attached RS-422/485 terminal block of analyzer using appropriate cables. Remove this terminal block from the analyzer first and then connect the cables.

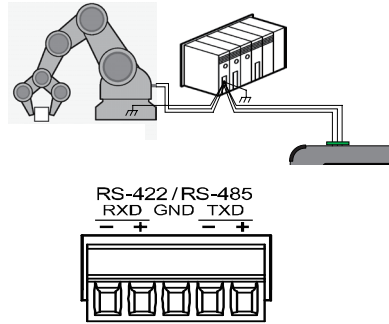

Connect SG (signal ground) of target device and SG of analyzer certainly.

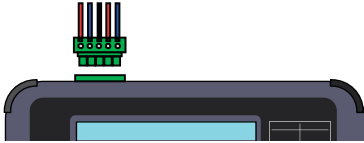

■ RS-422Monitoring

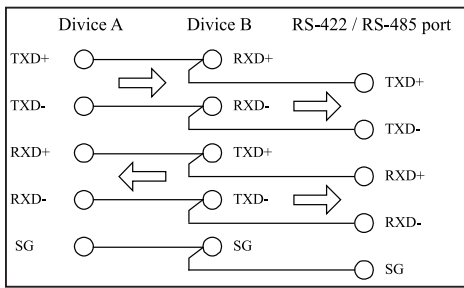

■ RS-422Simulation

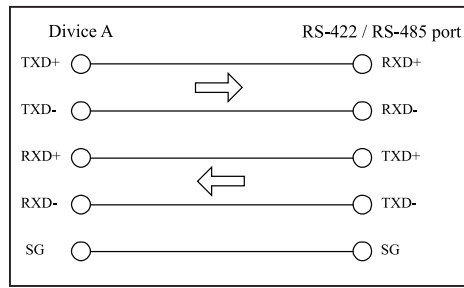

This is the example when analyzer is DTE mode.  
Turn on the terminal resistor of RXD on RS-422/485 port.

■ RS-485Monitoring/Simulation

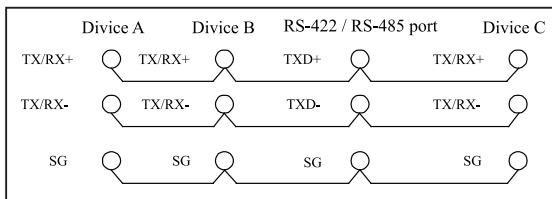

To measure RS-485 half-duplex, the analyzer is connected as one of the RS-485 nodes.  
If the analyzer is connected as left figure, set the analyzer to be “DTE” for simulation.  
If the analyzer is placed on the termination of the line (without equipment C on left figure), set “on” the termination resistance of TXD for RS-422/485 port.  
The transmit/received data are measured on TXD on the analyzer.

For RS-485 half-duplex data, the analyzer cannot recognize which data come from equip A or B and monitor both data on TXD. To distinguish them, add time stamp to have the end of frame.

■ Terminal resistance

If the analyzer is placed on the termination of the line, set 120Ω terminal resistance jumper (JP1: TXD, JP2: RXD) to be “1”.

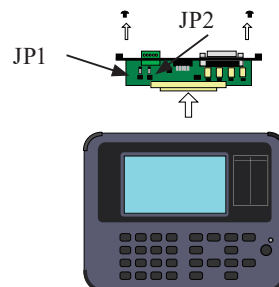
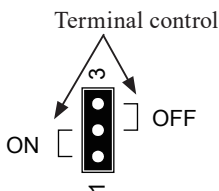

## Connect to TTL

To measure UART, I2C and SPI, set “Measurement port: TTL (5.0V) ~ (1.8V)” at “Interface” setting.

 2.3 Measurement Port

Connect appropriate signals to the TTL port of analyzer using the attached 5-line TTL probe cable (model: LE-5LS).

-  TTL port is 2.54mm pitch 10 pin MIL box type connector. Use the one equivalent to “HIF3FC-10PA-2.54DS(71)” of HIROSE Electric. Co., Ltd.
- When measuring analog signals, connect the OP-8AH or OP-8AT to the TTL port with the attached pod connection cable.

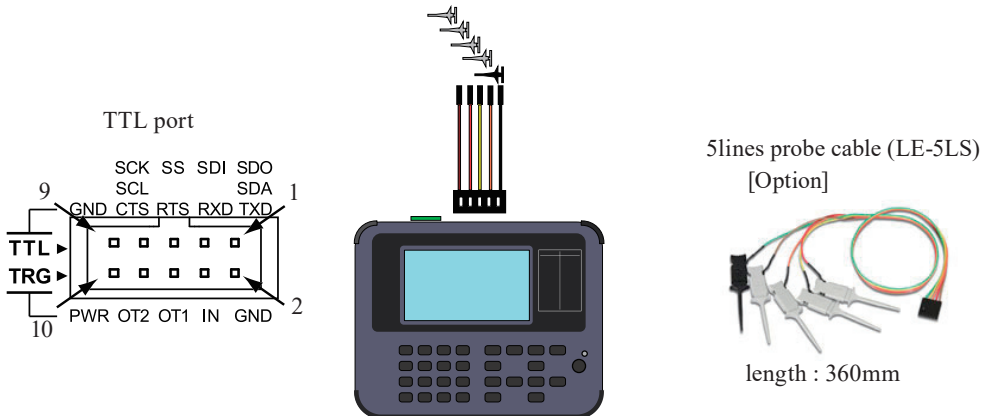

<Example of connection for UART>

Signal	Pin No.	Lead wire	Input/Output		Signal of target device	
			Monitor	Simulation	Monitor	Simulation
TXD	1	Brown	I	O	TXD	RXD
RXD	3	Red	I	I	RXD	TXD
RTS	5	Orange	I	O	RTS	CTS
CTS	7	Yellow	I	I	CTS	RTS
GND	9	Green	-	-	Signal GND	Signal GND

-  “I” indicates an input to the analyzer. “O” indicates an output from the analyzer.



<Example of connection for I2C>

Signal	Pin No.	Lead wire	Input/Output		Signal of target device	
			Monitor	Simulation	Monitor	Simulation
SDA	1	Brown	I	I/O	SDA	SDA
SCL	7	Yellow	I	I/O	SCL	SCL
GND	9	Green	-	-	Signal GND	Signal GND

-  “I” indicates an input to the analyzer. “O” indicates an output from the analyzer.

<Example of connection for SPI>

Signal	Pin No.	Lead wire	Input/Output		Signal of target device	
			Monitor	Simulation	Monitor	Simulation
SDO	1	Brown	I	I/O	MOSI	MISO
SDI	3	Red	I	I	MISO	MOSI
SS	5	Orange	I	I/O	SS	SS
SCK	7	Yellow	I	I/O	SCK	SCK
GND	9	Green	-	-	Signal GND	Signal GND

-  “I” indicates an input to the analyzer. “O” indicates an output from the analyzer.
-  If it is a master simulation, SS and SCK will be output (O). And, if it is a slave simulation, they will be input (I).

■ Connection and use of analog pods (OP-8AH, OP-8AT)

Turn off the power and connect an analog pod (sold separately) to the TTL port.

If you turn on the power while holding down [SHIFT] and [1], it will become an analog measuring instrument, and from the next time on, it will start up as an analog measuring instrument just by turning on the power.

\*Turn on the power while holding [SHIFT] and [0] to return to the communication analyzer.

 Chapter 7 How to use as an analog measuring instrument

 Expansion Interfaces

Expansion boards widen the targets of communications.

■ Exchange interface board

Remove the standard interface board first, then exchange to the optional interface board.

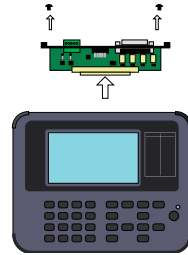

○ In-vehicle communication

CAN/CAN FD/CXPI

Use OP-SB7XC

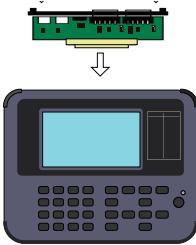

○ In-vehicle communication

CAN/CAN FD/LIN

Use OP-SB7XL

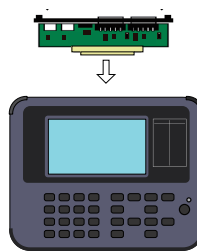

○ SYNC-clock TTL communication

Use OP-SB5GL

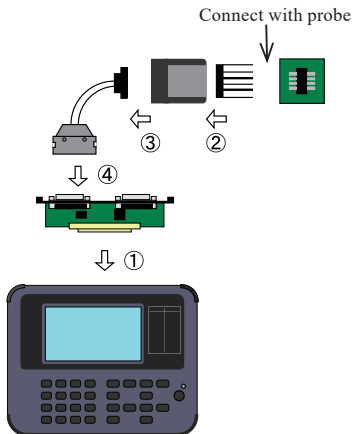

○ Current-loop communication

Use OP-SB1C

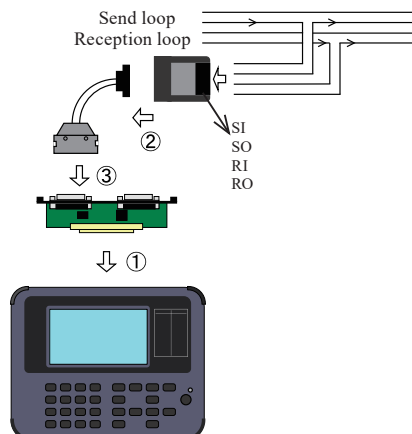

■ Firmware for expansion board

Firmware for expansion board is available at LINEEYE web page. Write the firmware into the analyzer using “le8firm.exe” which is stored in the attached CD. Once writing the firmware into the analyzer, appropriate firmware will automatically run according to the inserted interface board.

 11.5 Firmware Update

 For optional firmware “OP-FW10XR”, press [SHIFT]+[0] or [SHIFT]+[3] to exchange the standard firmware and optional firmware.



# Chapter 3 Monitor Function

## 3.1 Online Monitoring (ONLINE)

The monitor function records measured data in the capture buffer without impacting on a communication channel. Also, it displays data clearly following each communication protocol. Not only communication data but also the time stamp and idle time are recorded. As a result, error time and time out conditions can be investigated.

### Setting

Select “ONLINE” at “Function” at the top menu. Configuration (communication conditions) needs to be set in advance.

-  2.3 Measurement Port
-  2.4 Measurement Function
-  2.5 Communication Condition

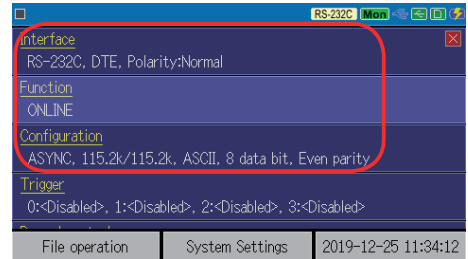

### Operation

To start measurement, press [RUN]. Then, data will be recorded in the capture buffer while displaying data on the screen. Transmission and reception data is displayed in two lines as one set. “” is the mark which indicates the place of new data.

< Example of ASYNC data >

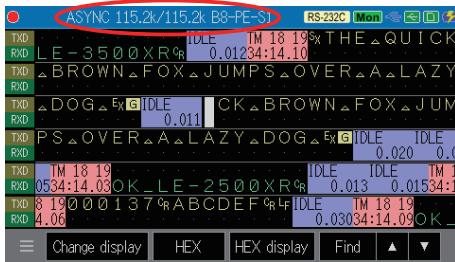

< Example of HDLC data >

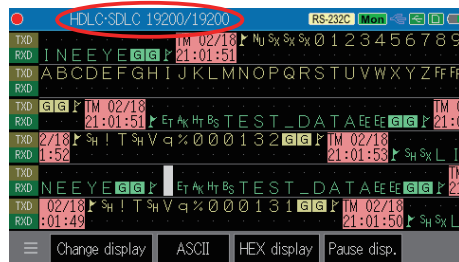

 On the top of the screen, selected protocol and speed are displayed. For ASYNC, bit structure is also displayed. (B: Data bit, P: Parity None(N) Odd(O) Even(E) Mark(M) Space(S) Multi-processor(P), S: Stop bit).

### Stop Renewing Display

Press [ESC] or touch “Pause”, then the motion on the screen temporarily seems to be stopped while measurement is still continuing. While it stops renewing the display, “Pause disp.” is displayed in green color.

 This operation will not affect trigger function or capturing data.

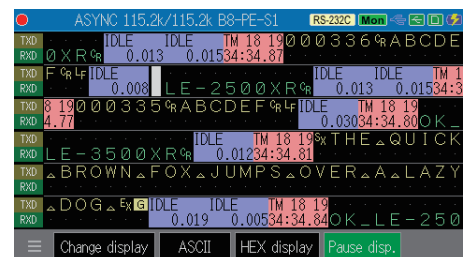

In order to cancel this, press [ESC] or touch “Pause” to go back to normal display.

## Character

Errors and breaks are displayed in unique characters.

Character	Description
PE	Parity Error (parity bit error)
FE	Framing Error (stop bit is “0”)
PF	Parity & Framing Error
B	Break (start bit, character bit, (parity bit), stop bit are all “0”).
A	Abort (7bits or more of “1” is continuously detected) (*1)
SF	Shart Frame (frame length is short)
G	Block check code normal (BCC or FCS is normal)
E	Block check code abnormal (BCC or FCS is abnormal)
7Eh	HDLC starting flag pattern (7Eh) is detected
7Eh	HDLC ending flag pattern (7Eh) is detected
03	Multi processor bit or acknowledge bit of I2C is “1”. (displayed in blue back)
7Eh	I2C (re)start sequence is detected.
7Eh	I2C stop sequence is detected.
0E	When the analyzer could not process the recording.
L	Cannot save all data by auto save function

\*1 :About **A** (ABORT) character on RS-485 line

On an RS-485 half-duplex line, if the line goes into a high-impedance state within 8 bit time after the completion of HDLC (NRZI) frame transmission,the line may go into the **A** state. In an actual communication system, such an ABORT frame will be discarded and no error will occur.

## Change Display Code

Once start measuring, data is displayed in selected data code set in the configuration setting. Touch the current data code (“ASCII” in the figure) to display in different data code.

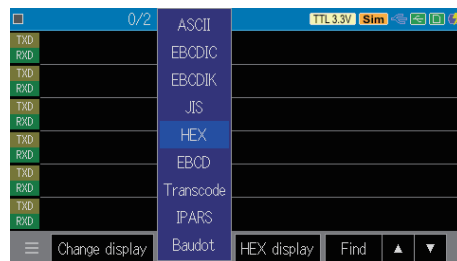
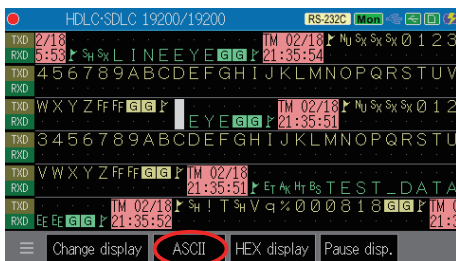

Touch “HEX” to display data in HEX, and touch it again to display in former display code.

- For HEX display, special characters and results of block check are also displayed in HEX.

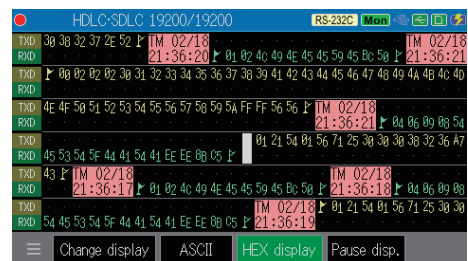

■ Time Stamp

The time, when the head of character of each frame running through the communication channel is received, is recorded in the capture buffer and displayed as following.

Min:Sec:10ms





Yr/Mon/Day Hr:Min





Mon/Day Hr:Min:Sec







-  Set the unit of time stamp from [MENU] -> “Record control” -> “Additional info.”.
-  Time stamp information consumes 4 bytes (for 3 units of time) or 8 bytes (for 5 units of time) of memory.

■ Idle Time

The time, when SD and RD keep non-communication status and a changeless status of signal lines, is recorded as following.

Resolution	Range	Example
100msec.	0~999.9sec.	
10msec.	0~99.99sec.	
1msec.	0~9.999sec.	

-  Set the unit of idle time from [MENU]->“Record control”->“Additional info.”
-  The time until reaching to be ASYNC, or receiving a specific address in HDLC is considered to be idle state without data existence.
-  If the time of one bit is slower than idle time (low speed communication), idle time may not be accurate.
-  “OVER” is displayed if it exceeds the range.

 2.6 Record Control

 Line State Display

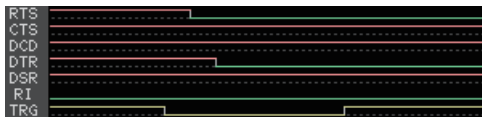

Status of control lines (RTS, CTS, DCD, DTR, DSR, RI) and trigger input (TRG) can be displayed in waveform. Control lines are displayed as high level when the line state LEDs light in read.

<Example of line state display>



The correspondences between line state LED and signal name on the screen.

Signal name	Line state LED		Signal name
RTS	RS(4)	(5)CS	CTS
DTR	ER(20)	(6)DR	DSR
		(8)CD	DCD
		(22)CI	RI

-  Names of line state LED are conformed to JIS X5101.
-  Set to record the control lines from [MENU] -> “Record control” -> “Additional info.” -> “Line state”.

 2.6 Record Control

## Change Display Format

Touch “Change display” to change data format

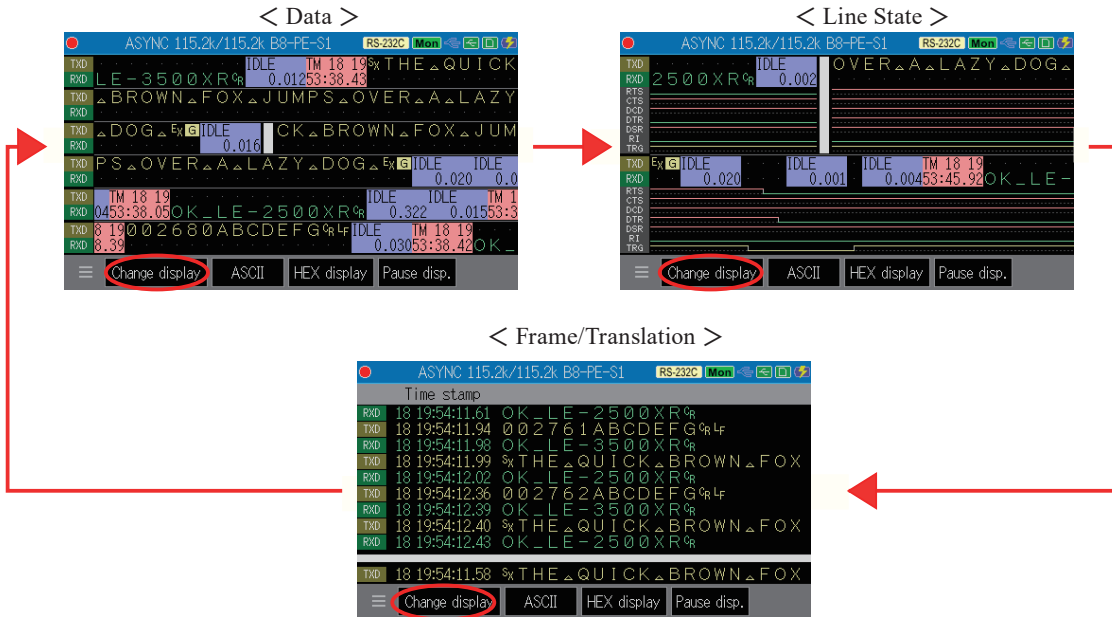

- It is not able to have “Line State” display without setting of recording control lines. Also, it is not able to have “Frame” display for ASYNC and Burst without setting of recording time stamp.
- When having the Wave monitor function, “Frame/Translation” display and then “Wave monitor” display will be appeared after the measurement.

## 6.3 Timing Waveform Measurement Function

## End of Measurement

Press [STOP] to stop measuring.

It is possible to stop measuring automatically under the specific conditions by the trigger function, or auto-run function.

- 2.6 Record Control ( Buffer Full Stop)
- 6.1 Trigger Function
- 6.7 Auto Run Function

## Scroll and Jump

### Scroll

Swipe the data to scroll measured data.

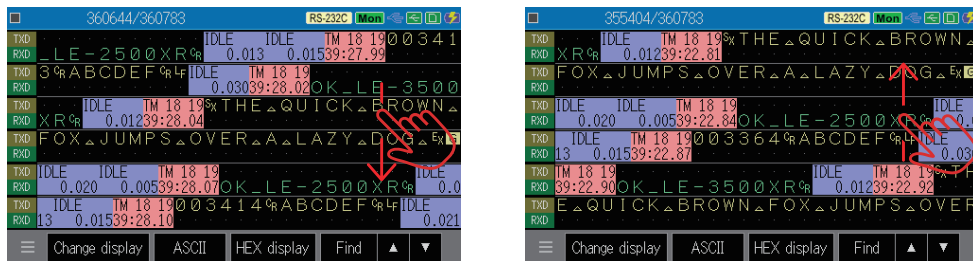

Swipe down the display to see backward (old) data.

Swipe up the display to see forward (new) data.

Also, use keys to scroll data, and [SHIFT] + [▲] or [SHIFT] + [▼] to jump to another page.

## ■ Jump

Touch the positioning number on top of screen which indicates the current position out of total data.

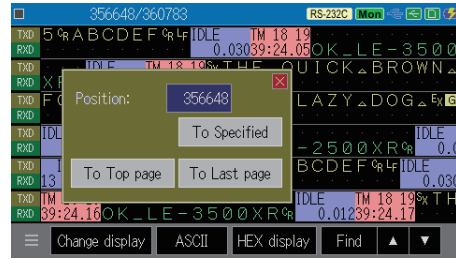
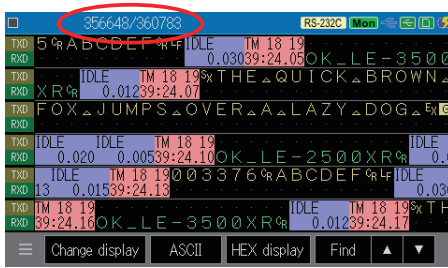

Type the positioning number using [0]-[9] keys and press [ENTER] to see the specified data.

- ☰ Touching “☰” in the left bottom of screen can jump to a specific data too.
- ☰ If inputted position No. is bigger than existing No., the last page will be displayed.

[TOP/DEL] Key, or touch “To Top page”: Display the oldest data (positioning number 0).

[END/X] Key, or touch “To Last page”: Display the latest data.

## 📖 Mark & Jump

It is able to mark the specific data and return to that position any-time.

Touch “☰” -> “Set to maker” -> “Marker 0” ~ “Marker 4” to register current position on the marker.

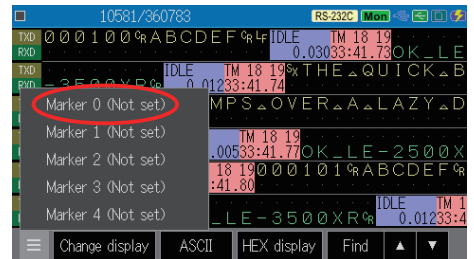

To return to the position of marker, touch “☰” -> “Move to marker”, and select the marker number.

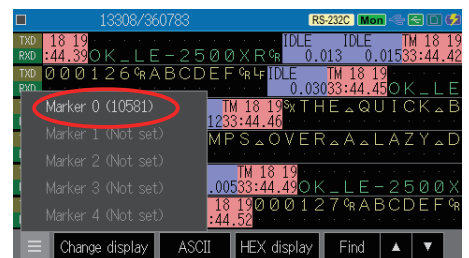

## Protocol Translation Display

Touch “Change display” some times and change the display to Translation display. For ASYNC, SPI and Burst, there is no Translation display. (there is Frame display)

### □ HDLC • SDLC

Touch “Frame” and “X.25” on the bottom of screen and select the specification of Translation display. It is able to change the specification of Translation display anytime. (during test too)

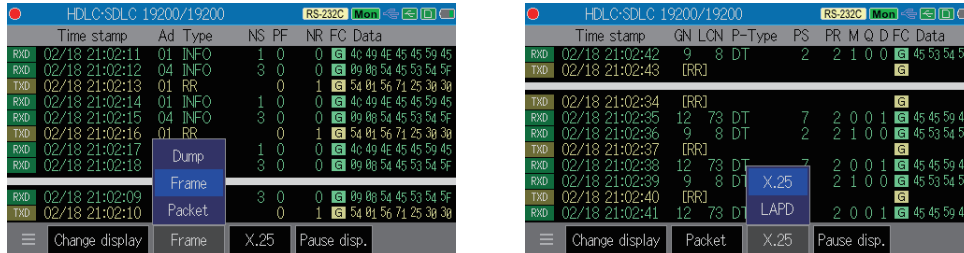

At the beginning of measurement, it displays data according to the settings of configuration.

**Dump** Display one frame per a line in HEX.

**Frame** Translate the address and control part on top of the frame.

**Packet** Translate the packet after the control part.

### Specification of Frame Translation for SDLC, SDLCCE, X.25, X.25E

Item	Meaning
Time stamp	Shows the time when the frame was received.
Ad	Displays the contents of the address field in HEX codes.
Type	Displays the frame type in the form of mnemonic.
NS	Displays the frame sequence number with the decimal notation.
PF	Displays the logical value of P/F bit.
NR	Displays the frame sequence number with the decimal notation.
FC	Displays the results of frame check.
Data	Displays the information field data.

SDLC/X.25 frame translation operates by modulo 8, and SDLCCE/X.25E frame translation operates by modulo 128.

### Specification of Frame Translation for LAPD

Item	Meaning
Time stamp	Shows the time when the frame was received.
SAP	Displays the value of service access point identifier with the decimal notation.
TEI	Displays the value of the termination point identifier of the terminal with the decimal notation.
CR	Displays the value of COMMAND RESPONSE display bit.
Type	Displays the frame type in the form of mnemonic.
NS	Displays the frame sequence number with the decimal notation.
PF	Displays the logical value of P/F bit.
NR	Displays the frame sequence number with the decimal notation.
FC	Displays the results of frame check.
Data	Displays the information field data.

Specification of Packet Translation for X.25

Item	Meaning
Time stamp	Shows when the packet was received.
GN	Indicates the logic channel group number with the decimal notation.
LCN	Indicates the logic channel number with the decimal notation.
P-Type	Indicates the packet type in mnemonic.
PS	Indicates the packet transmission sequence number with the decimal notation.
PR	Indicates the packet transmission sequence number with the decimal notation.
M	Indicates the logical values of more data bit.
Q	Indicates the logical values of qualifier bit.
D	Indicates the logical values of transmission verification bit.
FC	Displays the results of frame check.
Data	Indicate the information field data after the packet in HEX.

Specification of Packet Translation for LAPD

Item	Meaning
Time stamp	Shows the time when the packet was received.
PID	Displays the protocol identifier with the hexadecimal notation.
Message	Displays the contents separately for message type in the form of mnemonic.
CRF	Displays the value of nominal number flag.
CR	Displays the value of nominal number with HEX.(Maximum 2 octet)
FC	Displays the results of frame check.
Data	Displays the first five bytes of the information field data in HEX codes.

 10.5 Translation Display Specification

□ ASYNC-PPP

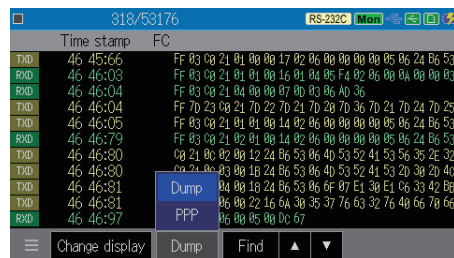
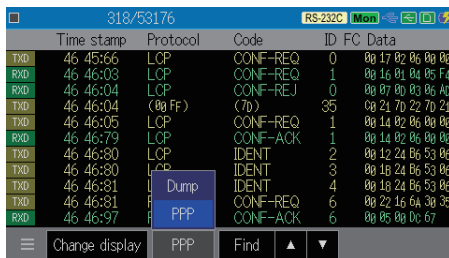

Touch “PPP” on the bottom of screen and select “Dump” or “PPP”.

It is able to change the specification of Translation display anytime. (during test too)

Dump      Display one frame per a line in HEX.

PPP        Translate the address and control part on top of the frame.

Item	Meaning
Time stamp	Shows the time when the frame was received.
Protocol	Translates and displays the protocol value.
Code	Translates and displays the code field value.
ID	Displays the value of identifier field as decimal figure.
FC	Displays the results of frame check.
Data	Displays the information field data after message type in HEX.

 10.5 Translation Display Specification

□ MODBUS

Touch “MODBUS” on the bottom of screen and select “Dump” or “MODBUS”.  
It is able to change the specification of Translation display anytime. (during test too)



Dump      Display one frame per a line in HEX.

MODBUS   Translate the address and control part on top of the frame.

Item	Meaning
Time stamp	Shows the time when the frame was received.
SA	Display the device address in decimal.
Function/Sub-function	Display the value of function code in mnemonic.
FC	The result of frame check (LRC).
Data	Display the contents of data field in HEX.

10.5 Translation Display Specification

□ I2C

The description of translation display for I2C is following.

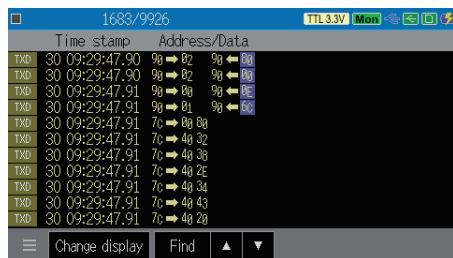

Item	Meaning
Time stamp	Shows the time when the frame was received.
⇒	Transmission data of master.
←	Reception data of master.
00 etc.	Non-acknowledge data.
Address/Data	Display the slave address and data in HEX.

## Bit Shift Function

This function shifts the separation of characters of received data bit by bit, to find errors such as deviations from the character synchronization of serial data.

When the characters are displayed on the data display, press [SHIFT]+[◀]. Then, the character separation is shifted one bit from the lower bit to the upper bit.

Press [SHIFT]+[▶], and the character separation is shifted one bit from the upper bit to the lower bit. A mark bit ('1') is added to the lowest (or highest) bit position where continuity of the data is broken, such as the head character of a frame.

- ☰ The bit shift is applied only to the screen and not applied to the data in the memory.
- ☰ The scroll paging operation eliminates the bit shift operation.
- ☰ Successive bit shifts can be made up until the number of bits constituted a character.

e.g.) CODE: EBCDIC, bit length 8

LSB side (first arrived bit) ← Order of bits arrival → (last arrived bit) MSB side

### Before shift

Received data      10011000    10011001    00000110    10000111    10000110  
                          'E' 19h    'r' 99h    '-' 60h    '\E' Eh    '/' 61h

### After 1 bit shift

Received data      01001100    01001100    10000011    01000011    11000011  
                          'I' 33h    'S' 32h    'A' C1h    'B' C2h    'C' C3h  
                          ↑  
                          Mark bit added

## 3.2 Retrieval Function

The retrieval function finds specific data among the vast amount of data recorded in the capture memory. It also counts the number which satisfies a particular condition.

### Retrieval Setting

Touch "Find" on the bottom of screen and select the factor at "Find factor".

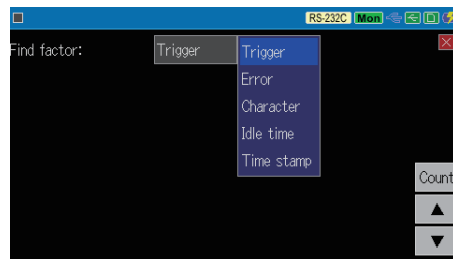
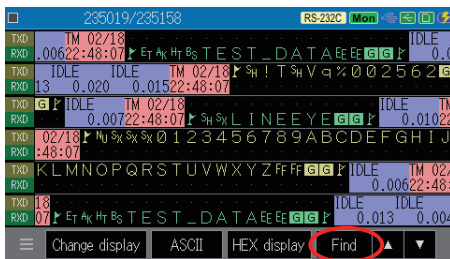

### Find factor

- Trigger  
Data which satisfies the trigger condition (Factor) is retrieved. Trigger is not retrieved in the case the trigger condition is "Timer/Counter".
- Error  
Retrieve errors which are selected.
- Character  
Retrieve data string up to 8 character.

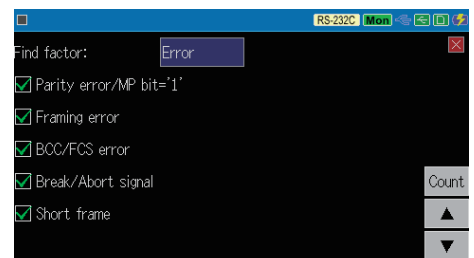

- Target line  
Select the target line from TXD or RXD.

- Character  
Input the data string in HEX by [0]~[F] and [END/X] keys. To set the bit mask or HDLC frag, touch “W0”~“W2” or frag mark on the right bottom of screen.

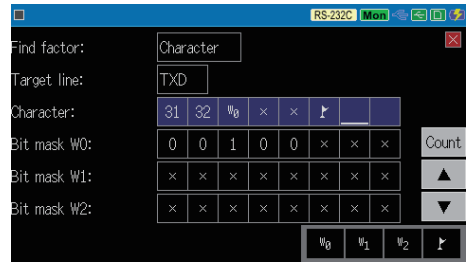

☰ In the right figure, “W0” should be matched with 30h ~37h, and 2 bytes of frame error code is “x”, and there is an end frag.

- Idle Time  
Retrieve idle time which exceeds the set value.  
The unit of idle time for retrieval should be the same unit of idle time when it is measured.  
To retrieve the data with timeout, input the timeout time here.

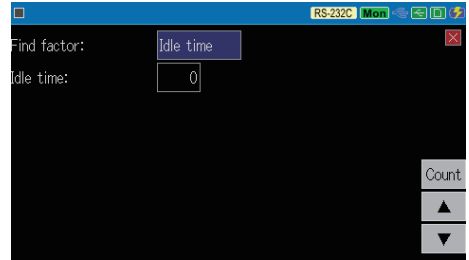

- Time Stamp  
Retrieve specified time stamps. The setting unit of time stamp for retrieval should be the same unit of time stamp when it is measured.  
Specifying data with time stamp enables to find data when communication trouble occurs.

☰ In the right figure, it retrieves the data between 22:46:30 on Feb. 18th and 22:47:00 on Feb. 18th.

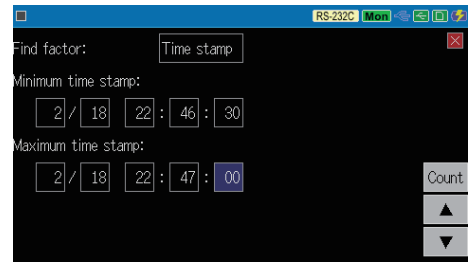

## Start Retrieval

Touch “▼” or “▲” to start retrieval. When find the matched data, it displays data on top of the screen.

- “▲” : Retrieve previous (older) data, starting from the top of data displayed on the screen.
- “▼” : Retrieve backward (newer) data, starting from the top of data displayed on the screen.

Touch “count” on the right bottom of screen to count data matched with the retrieval conditions. “Not found” is displayed if there is no matched data.

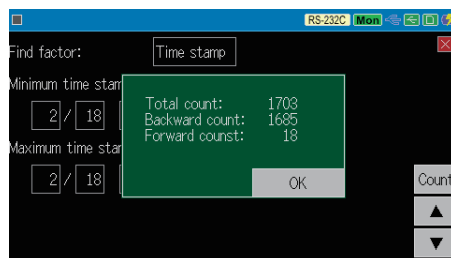

### 3.3 Delay Time and Signal Voltage (DELAY)

Delay Time function measures the delay time between state changes of the interface signal, and measures the voltage (MAX. MIN. Now) of the signals of RS-232C or TTL.

#### Setting

Press [Menu] and then touch “Function” -> “Operation: Monitor” -> “DELAY”. Touch “Advanced setting” on the bottom of the screen.

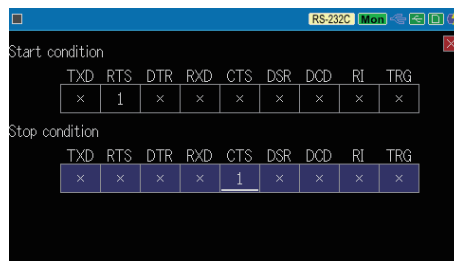
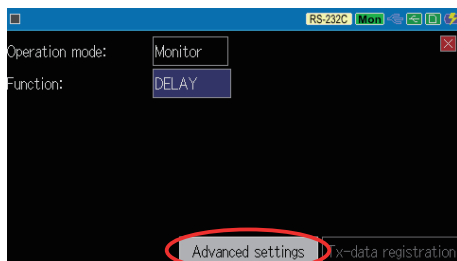

#### Start condition

The following nine signal lines are needed to be set : TXD, RTS, DTR, RXD, CTS, DSR, DCD, RI, and TRG (external trigger signal). Specify the state of each signal by [1](on state), [0](off state), and [END/X](don't care).

#### Stop condition

Specify the state of each signal as same as start condition.

- ☰ “On state” indicates the active state of signal. For RS-232C, it is +3 or higher (space state) of voltage level. For TTL, it is a low level.
- ☰ For TTL, only TXD, RXD, RTS and CTS are the target signal lines. For RS-422/485, only TXD and RXD are the target signal lines.

#### Target port for measuring signal voltage

To measure TTL, set the measurement port to “TTL” at “Interface” setting. If it is set other than “TTL”, RS-232C will be the target port.

#### Start and End of Measurement

Press [RUN] to start measuring of delay time and signal voltage.

Analog input voltage (V,24)			
	Current	Minimum	Maximum
TXD	+5.9 V	-5.7 V	+6.5 V
RXD	-5.3 V	-5.8 V	+6.2 V
DTR	+5.7 V	0.0 V	+6.3 V
DCD	+5.6 V	-5.7 V	+6.4 V

Signal line delay				
Times	Current	Minimum	Maximum	Average
166	4.5 ms	9.0 ms	54.5 ms	18.2 ms

☰ Pause disp.

Press [Stop] to stop measuring.

#### Display of signal voltage

Measure voltage of target interface and display signal voltage (MAX. MIN. Now).

Target signals

For RS-232C port	TXD,RXD,DCD,DTR
For TTL port	TXD,RXD,RTS,CTS

### Range of signal input

For RS-232C port	-18V ~+18V
For TTL port	-1V ~ +6V

Resolution of voltage measurement is 0.1V.

### ■ Display of delay time

Delay time is the time between start and stop condition of the signals, and displayed by Max. Min, resent (Now) and average. The start/stop conditions are established when the nonconformity of the two conditions becomes the conformity of those. Thus, start/stop conditions will not be established when they are conformed from the beginning.

The change of signals within 0.1ms cannot be detected. (resolution is 0.1ms)

If the resent value (Now) exceeds the range of signal input, "Overflow" will be displayed. And, the value of "Max" and "Min" may not be accurate, even though it keeps measuring the next target.

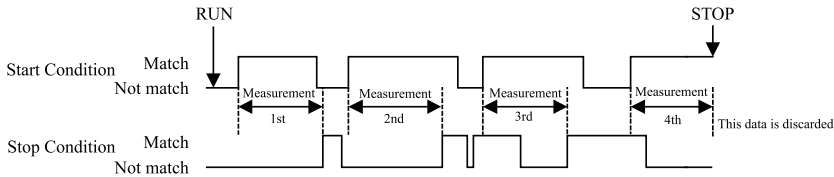

## 3.4 Statistic Analysis Function (TREND) [LE-3500XR only]

The statistical analysis function is capable of counting the occurrence of the events such as the number of characters and frames in a specific period, and displaying the results on graph to check how the occurrence of them changes over time. This function is useful to check the frequency of the use of a channel.

### Setting

Press [MENU] and touch "Function" -> "Function: Monitor" -> "TREND". Touch "Advance settings" on the bottom of screen.

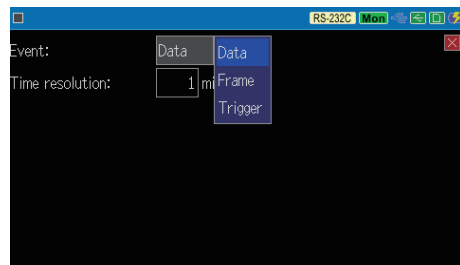
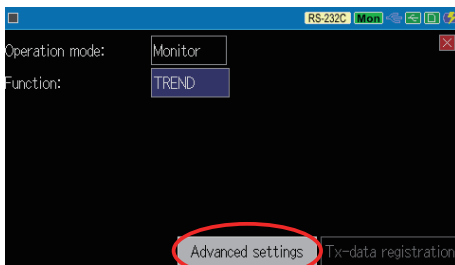

### ■ Event

<Example of above program>

**Data** All data on the TXD and RXD is the target. It is useful to check the traffic on the line.

**Frame** All frames on the TXD and RXD is the target.

**Trigger** The target is the occurrence of trigger 0 or trigger 1. It is useful to check the frequency (trend) of specific error or data.

When using the statistical analysis function, only timer control, counter control, and trigger control are used for trigger operation, and no other operations are performed.

Set the trigger to match the target event.

## ■ Resolution

Set a resolution, unit time for statistical processing, on a horizontal scale of a graph. (1 ~ 240 min.) Statistically processed data up to Max. 2000 times can be recorded.

☞ If setting 10 min. for the resolution, it can measure 20,000 min. (333 hours 20 min.)

## 📖 Start and End of Measurement

Press [Run] to start measurement.

As a number of times of statistical processing passes, the results of calculated value are updated on a graph. A vertical scale is automatically adjusted according to the results of data.

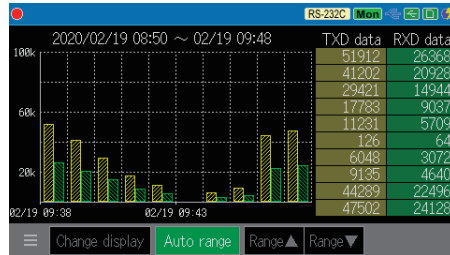

Press [STOP] to stop measuring. After 2000 times of statistics, it will finish measuring automatically.

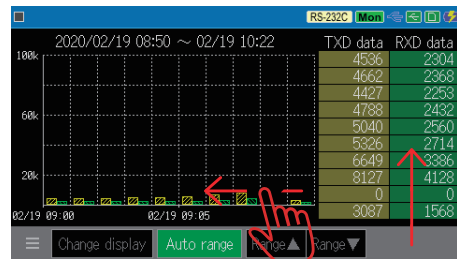
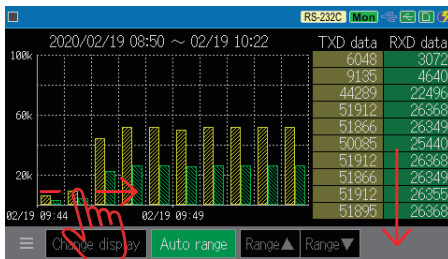

☞ Also, it is able to scroll data by [◀], [▶] and go to next (previous) page by [SHIFT]+ [◀],[SHIFT]+ [▶]

☞ Display the beginning/end of data by pressing [TOP/DEL]/ [END/X].

## ■ Change vertical scale

To change the range of vertical scale manually, touch “Auto range” to release this function. And then touch “▼”, “▲” to change the range.

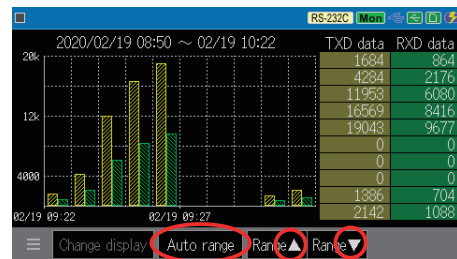
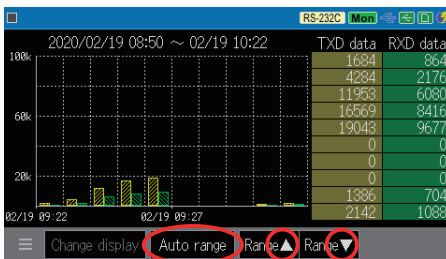

## Chapter 4 Simulation Function

The simulation function is the tool that makes the analyzer operating as a communication partner with a test device, and that executes a test for transmission and reception following protocols. Even if communicated devices are not prepared at the first step in developing, the testing like real operation will be able to be executed. After checking communication procedure in our original "MANUAL mode," complicated communication procedure with conditional branches will be able to be tested by command-selected easy programming. A margin can be evaluated at staggered communication speed on purpose because appointed communication speed can be set. Moreover, error processing response can be checked with tested data which includes parity error data.

### ■ MANUAL Mode

Registered data of the transmission table corresponding to operation keys [0] to [F] is transmitted one touch every time each key is pressed. Communication procedure can be easily tested with the trigger function checking response from the developed devices through the monitor function. In addition, by pressing [SHIFT] and one key from [0] to [D] fixed data corresponding to each key can be transmitted. Also, pressing [SHIFT] and [E],[F] makes the signal line of RTS/CTS or DTR/DCD set ON/OFF.

### ■ BUFFER Mode [LE-3500XR only]

Recorded transmission or reception data is selected in a memory through the monitor function. And then, that data is transmitted as simulation data. It is useful to perform a reproducing test for data with the same communication state monitored in the field.

### ■ FLOW Mode

As a transmitter or a receiver, X-ON/OFF flow control and control line handshake can be simulated. In the transmission mode, the number of transmission data for sixteen times can be displayed from a start to an interrupt request. On the other hand, in the reception mode, two things can be appointed. One is the number of reception data of until an interrupt request is submitted for transmitting. The other is time of until a start request is submitted for transmitting.

### ■ ECHO Mode

Received data is turned back from the analyzer. It is used for testing a communication terminal (display terminal etc.) and used as a loop-back point for BERT.

### ■ POLLING Mode

The slave side or the master side based on polling communication procedure of multidrop (1:N connection) is simulated. In the slave mode, the number of frame reception times and an error is checked at the self-address. And then, appointed data is replied. In the master mode, polling messages are transmitted to 32 kinds of the slave addresses. And then, response data is checked in each slave address.

### ■ PROGRAM Mode [LE-3500XR only]

By programming for a dedicated command, communications protocol involved in the conditional judgment is flexibly simulated. There is the selectable menu for programming so it is easy to master this mode.

## 4.1 Register Transmission Data

Register transmission data in the data tables before starting simulation. For Polling/Program mode, this registered data is used as comparison data with received data.

 For Buffer/Echo mode, data table is not used.

### Register data

Data code and BCC/FCS used in the registration table are set on the configuration setting. Press [MENU] and then touch “Configuration” and confirm the communication conditions.

 2.5 Communication Condition

Press [MENU] and then touch “Function” -> “Operation mode: Simulation”. Touch “Tx-data registration” on the bottom of screen.

There are 160 kinds of transmission data tables from No.00 to No.9F. And, total of 16384 characters can be registered. At the beginning, some tables of Group0 are displayed on the screen. Touch “Group0” on the bottom of screen to change to the group.

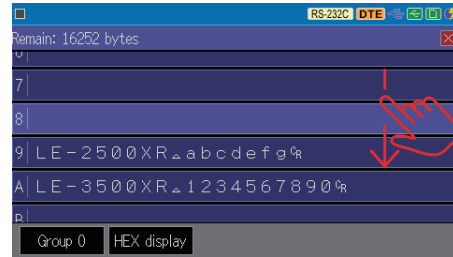
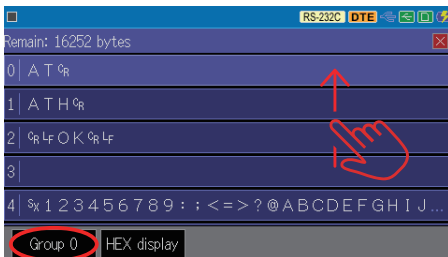
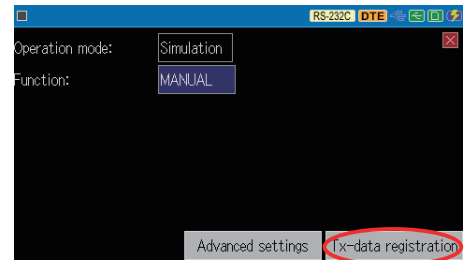

 Only the first 27 characters are displayed on the screen.

Swipe the screen of data tables to display more tables. Also, it is able to select the table by [▼],[▲] and press [ENTER].

 It is able to select the table No. by [0]~[F] key.

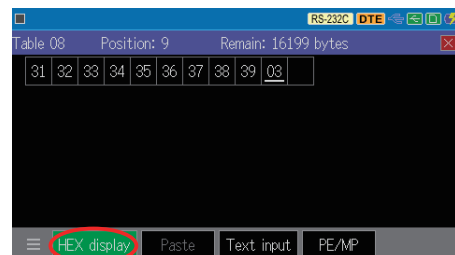
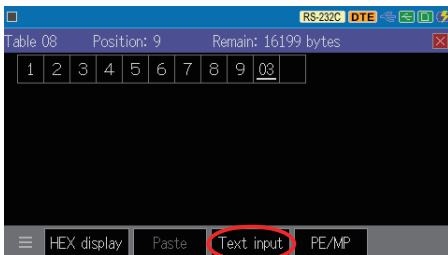

On top of the screen, table number, position of cursor, and rest of buffer (remained bytes) on the transmission data table are displayed. A cursor position on the screen where under-line is blinking is the place to input data. Move the cursor position by [◀],[▶],[▼],[▲] or touch the place. Input registration data by [0]~[F] in HEX, or touch “Text input” on the bottom of screen. Inputted data is displayed with the selected data code. Touch “HEX display” to display data in HEX.

To see the first or last data, touch “” and select “first data” or “last data”.

- To see the first or last data, press [SHIFT]+[TOP/DEL] or [SHIFT]+[END/X].
- To modify entered data, move the cursor to the position and modify data.
- To delete entered data, move the cursor to the position and press [TOP/DEL].

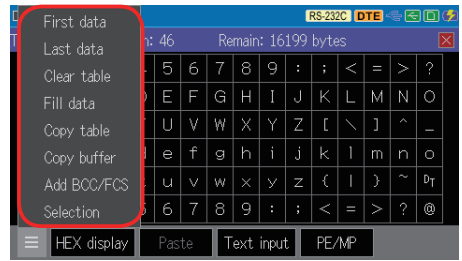

### Text input

Touch “Text input” to enter data by a key board. Entered data is appeared on the top of screen. Change to capital letter by “Caps”, and change to symbols by “A<->#”. Press [ENTER] or touch “OK” at the end. Entered data will be inserted in the previous transmission data tables.

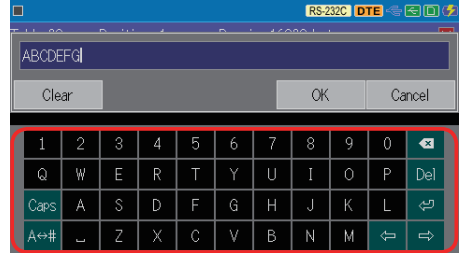

- It is able to use [0]~[F] keys for inputting character 0~F.
- Input text remains in the text box until turning off the power. Touch “Clear” to delete data.

### Parity Error and MP Bit Setting

Touch “PE/MP” or press [SHIFT] + [E] to generate a parity error or MP bit (to be 1). Generated data is marked on red. To cancel the setting, touch/press the button one more time.

- Set the type of “parity” in the “Configuration” setting.

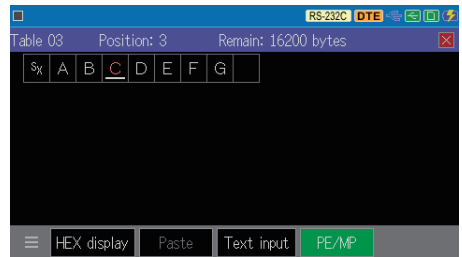

### BCC/FCS Auto Calculation

Press [SHIFT]+[ENTER] to calculate BCC/FCS automatically and add it on the data.

#### 10.1 Calculation of the Block Check

In the right figure, “02h(SX), A, B, C, D, E, F, G, 03h(EX)” is inputted. By pressing [SHIFT]+ [ENTER], 2 bytes of BCC (DEh, 2Ch) is automatically added on the data. BCC setting of this example is below.

BCC : CRC-16, Starting code: 01h or 02h, End code: 03h or 17h.

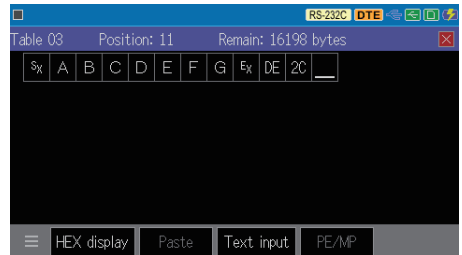

- Press [SHIFT]+[ENTER] again when you change the “Configuration” of “BCC”.

### Data code and data bit

Inputted data is displayed with the selected data code. (“Configuration” -> “Data code”)

And, the data code cannot be changed by “SHIFT IN” and “SHIFT OUT” operation. Also, the data bit has to be same as configuration. (“Configuration” -> “Data bit”) For example, if data bit is set as “7”, “13h” will be sent instead of wrong inputting “93h”.

### Unnecessary data

Parity bits, Sync code (reset code) for SYNC/BSC and start (end) flag for HDLC/SDLC are added and transmitted automatically. Therefore, it is not necessary to include them in the registration data.

■ Copy, cut and paste

Touch “☰” -> “Selection” or press [ENTER]. Then, “copy” and “cut” will be appeared on the bottom of screen. Selected data on the cursor is marked on blue.

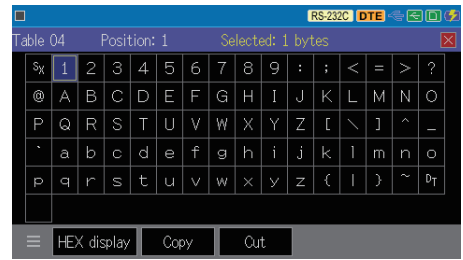



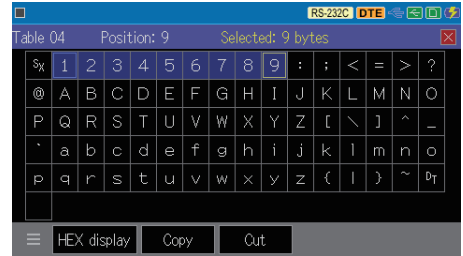

As the cursor is moved with characters selected, they will be marked on blue.

Touch “copy” or press [END/X] to copy the data, or touch “cut” or press [TOP/DEL] to cut the data on the clip board.

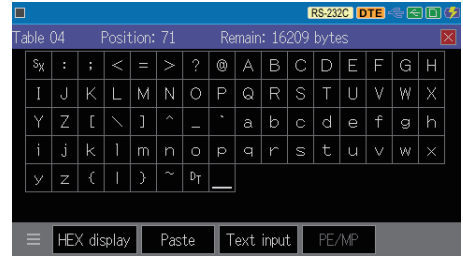

Move the cursor to the place needed to be pasted, and then touch “paste” or press [END/X].



-  The number of selected byte are displayed on the top of screen.
-  Data selection ends after pressing [ESC] or touching another data.
-  Copied or cut data on the clip board will be eased after turning off the power.

■ Delete table

Touch “☰” -> “Clear table” to delete a table. Touch “Execute” or press [ENTER]. To cancel this operation, touch “Cancel” or press [ESC].

■ Fill in data

Touch “☰” -> “Fill data” and specify the begin data, end data and filling size. Touch “Execute” or press [ENTER].

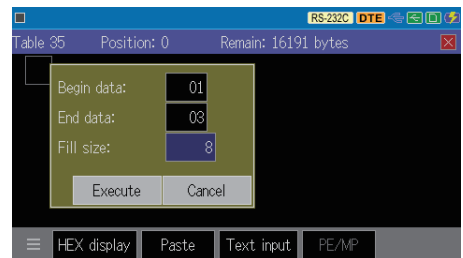



Begin data< End data : A character from “Begin data” toward “End data” will be inputted increasing one by one till the number of size set in “Fill size” is filled.

Begin data> End data : A character from “Begin data” toward “End data” will be inputted decreasing one by one till the number of size set in “Fill size” is filled.

Begin data= End data : The data is entered into the table for the specified size.

On the right figure, “01h, 02h, 03h, 01h, 02h, 03h, 01h, 02h” will be inserted in the table.

-  Input “Begin data” and “End data” by [0] ~ [F] in HEX.
-  If there is not enough remains, it will fill the data partway.

■ Copy table

Touch “☰” -> “Copy table” and select the Group No. and Table No.

■ Copy buffer

It is able to copy monitored data into the table. At first, display monitored data on the screen and adjust the head of data to be copied on the upper left of screen. Touch “☰” -> “Copy buffer” and select “TXD data” or “RXD data” and copy size. Touch “Execute” or press [ENTER].

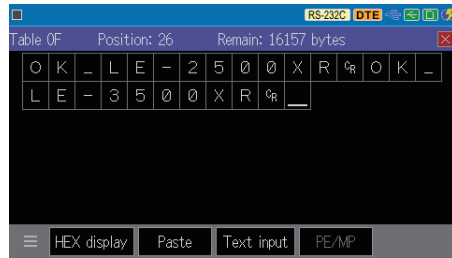
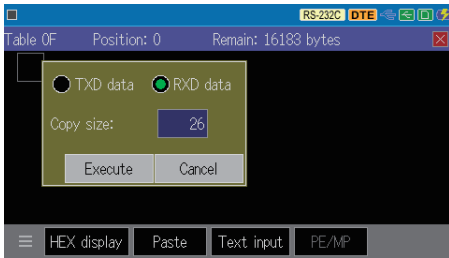
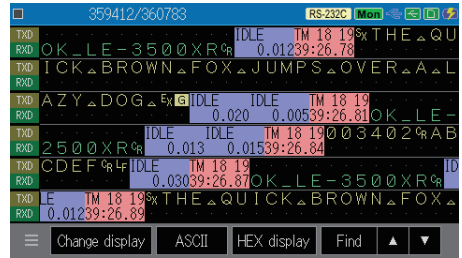

☰ Idle time and time stamp are not copied.

📖 Fixed Transmission Data (Pre-set data)

Special characters like ENQ, ACK, etc. can be inputted. Touch “☰” -> “Copy table” -> “Fixed data”. Also, they can be inputted with following shift keys.

[SHIFT]+[0]	ENQ	[SHIFT]+[7]	RVI
[SHIFT]+[1]	ACK	[SHIFT]+[8]	TTD
[SHIFT]+[2]	NAK	[SHIFT]+[9]	‘ FOX ’ Message (*1)
[SHIFT]+[3]	WACK	[SHIFT]+[A]	‘ MSG1 ’ Message (*2)
[SHIFT]+[4]	EOT	[SHIFT]+[B]	‘ MSG2 ’ Message (*3)
[SHIFT]+[5]	ACK0	[SHIFT]+[C]	DC1 (11h)
[SHIFT]+[6]	ACK1	[SHIFT]+[D]	DC3 (13h)

\*1 : THE QUICK BROWN FOX JUMPS OVER A LAZY DOG 0123456789.

\*2 : S<sub>x</sub>0123456789ABCDEF GHIJKLMNOPQRSTUVWXYZE<sub>x</sub> BCC

\*3 : 0123456789ABCDEF GHIJKLMNOPQRSTUVWXYZ C<sub>R</sub>L<sub>F</sub>

- ◆ HEX value of pre-set characters ([SHIFT] + [0] to [8]) are changed according to the selected data code in "Configuration" setting. Refer to following table.
- ◆ Characters, which are not defined in the code table, are ignored.

	ASCII/JIS/HEX	EBCDIC/EBCDIK	Transcode	Others
ENQ	05h	2Dh	2Dh	-
ACK	06h	2Eh	3Ch	-
NAK	15h	3Dh	3Dh	-
WACK	10h · 3Bh	10h · 6Bh	1Fh · 26h	-
EOT	04h	37h	1Eh	-
ACK0	10h · 30h	10h · 70h	1Fh · 20h	-
ACK1	10h · 31h	10h · 61h	1Fh · 23h	-
RVI	10h · 3Ch	10h · 7Ch	1Fh · 32h	-
TTD	02h · 05h	02h · 2Dh	0Ah · 2Dh	-

To receive data, it is necessary to register the same amount of dummy data.

□ I2C Master Mode

At first, set the slave address (including a read/write bit) and then set transmission/reception data. Start/stop sequence are added automatically at the beginning and end of data.

To receive data, it is necessary to set the same amount of dummy data.

 Touch “PE/MP” or press [SHIFT]+[E] to insert a re-start sequence.

e.g.1 : Transmit data (41h, 42h, 43h) to the slave address “1010000b” (7bit).

Register in the data table: A0h 41h 42h 43h

A0h (1010000b): Write request to the slave address

41h 42h 43h : 3byte of transmission data

e.g.2: Receive 3 byte of data from the slave address “1010000b” (7bit).

Register in the data table: A1h 00h 00h 00h

A1h (10100001b) : Read request to the slave address (bit 0=1)

00h 00h 00h : 3byte of dummy data

e.g.3: Transmit data (41h, 42h, 43h) to the slave address “1010000b” (7bit), and then receive 3 byte of data from the slave address.

Register in the data table: A0h 41h 42h 43h A1h 00h 00h 00h

A0h (1010000b): Write request to the slave address

41h 42h 43h : 3byte of transmission data

A1h (1010000b): Re-start + Read request to the slave address (bit 0=1)

00h 00h 00h : 3byte of dummy data

 Move the cursor to the “A1” then touch “PE/MP”.

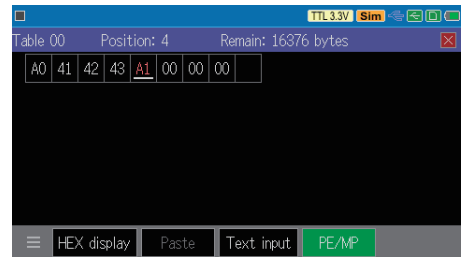

□ I2C Slave Mode

Set the transmission data to send after receiving a request from the master. To receive data, it is necessary to register the same amount of dummy data. Registered data (more than 1byte) is used repeatedly when it receives data from the master, and when it transmits data after receiving a request from the master.

e.g.1 : Transmit 31h, 32h, 33h, 31h, 32h, 33h after receiving 6 byte of send request from master.

Set the I2C slave address (7bit address) : 1010000b from [MENU]->“Configuration”.

Simulation mode: SLAVE

Address bit: 7 BIT

Slave address: 0A0

Register in the data table: 31h, 32h, 33h, 31h, 32h, 33h

 Registering only “31h, 32h, 33h” in the transmission data table will be the same result.

e.g.2: Receive 16 byte of data from master.

Register in the data table: 00h

 If there is nothing in the data transmission table, data cannot be received.

 To receive data, press [RUN] to start measuring and then press a corresponded key with data transmission data table No. before starting the communication from master. (Manual mode)

## 4.2 RS-422/485 Driver Control

Select the method of controlling RS-422/485 transmission driver IC for simulation on RS-422/485 port.

Press [MENU] then touch “Interface” -> “Measurement port: RS-422/485” -> “Driver control”. For an optional interface board, “OP-SB10N”, select “Measurement port: RS-530”.

 2.3 Measurement Port

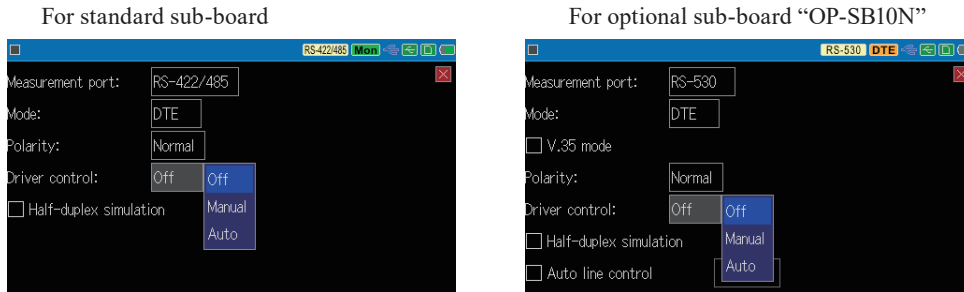

### ■ Driver Control

**OFF** : Select this for testing RS-422 (full-duplex), X.20/21, RS-449 and V.35 using “OP-SB10N”. Driver IC will always be in an enable state after starting test.

**Manual** : When DTR (for DTE mode) or DCD (for DCE mode) is ON, the driver will be in an enable state. And when DTR or DCD is OFF, the driver will be in disable (high impedance) state. It is used to control the driver IC manually for Manual or Program mode.

 When OP-SB10N sub board is inserted to the analyzer and "Auto line control" is checked, the driver IC is controlled according to the state in which the DTR and DCD are automatically controlled.

 When “Auto line control” is set OFF, the initial state at the start of simulation is below:

Simulation mode	Initial State of TXD Driver IC
MANUAL mode	High impedance state
FLOW Mode	Enable
ECHO Mode	Enable
POLLING Mode	Enable
BUFFER Mode	Enable
PROGRAM Mode	High impedance state

**AUTO** : Select “Auto” for testing RS-485 in half duplex. The driver automatically be in an enable state during the transmission of test data, and the driver will automatically be in disable after about 1 to 3 bits is delayed (400u seconds at least) after data transmission.

### ■ Half-duplex simulation

If you check this when performing a half-duplex simulation, you can separate and record the data sent from this unit and the other received data.

Data monitored on the TXD line while the unit is transmitting --> Recorded as TXD data

Data monitored on the TXD line while the unit is receiving --> Recorded as RXD data

Signals input to the RXD line are ignored (do not connect anything).

\* These are for when the mode is set to DTE. When the mode is set to DCE, the above TXD and RXD are reversed.

Do not check this item when simulating full-duplex.

## 4.3 Auto Line Control

ON/OFF of control lines and timing of data transmission can be controlled automatically according to the setting of interface mode (DTE/DCE) for simulation.

☰ “ON” means active, and “OFF” means non-active.

Press [MENU] and touch “Interface” and set “Mode” to “DTE” or “DCE”. Mark on “Auto line control” and touch “Setting”.

☰ For standard sub-board, this setting is available only for RS-232C port.

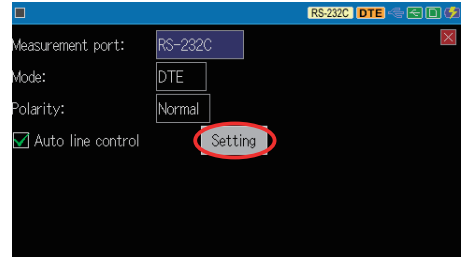

### ○ DTE mode

Set the timing of following item in the range between 0 and 9999 ms.

#### ■ RTS on

Time between the start of data transmission and RS becomes “ON.”

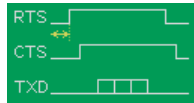

#### ■ TXD transmit

Time between CTS becomes “ON” and the start of data transmission.

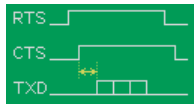

#### ■ RTS off

Time between the end of data transmission and RTS becomes “OFF.”

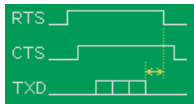

#### ■ DTR on

DTR is always “ON” during test.

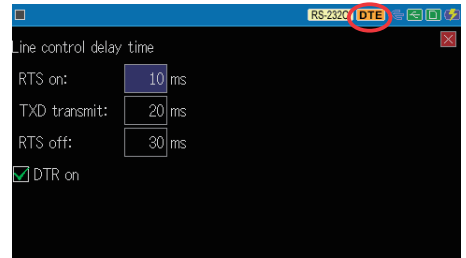

Example of above program

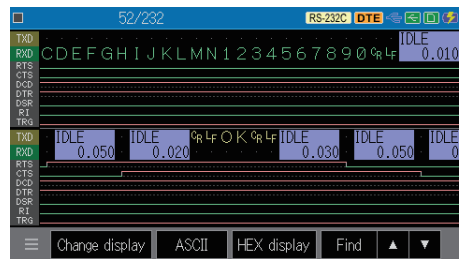

### ○ DCE mode

Set the timing of following item in the range between 0 and 9999 ms.

#### ■ CTS on

Time between RTS becomes “ON” and TXD becomes “ON”.



#### ■ CTS off

Time between RTS becomes “OFF” and TXD becomes “OFF”.



#### ■ DCD on

Time between the start of data transmission and DCD becomes “ON.”



#### ■ RXD transmit:

Time between DCD becomes “ON” and the start of data transmission.



#### ■ DCD off

Time between DCD becomes “OFF” and end of data transmission.

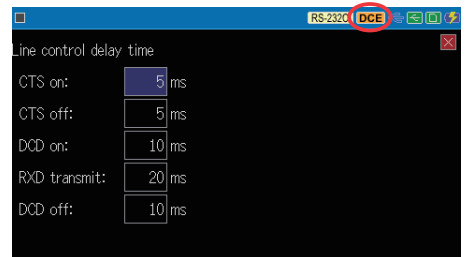

Execution of the above program

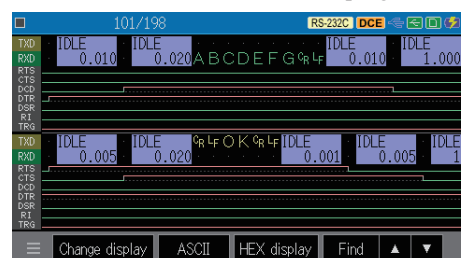



## 4.4 Manual mode

Data in the data table corresponding to each key will be transmitted by pressing a key.

### Setting

Before starting the Manual simulation, set protocol and communication conditions in the "Configuration", and register transmission data in the data table.

-  2.5 Communication Condition
-  4.1 Register Transmission Data

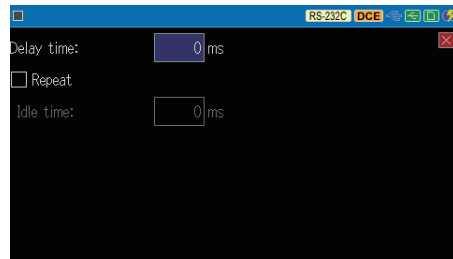
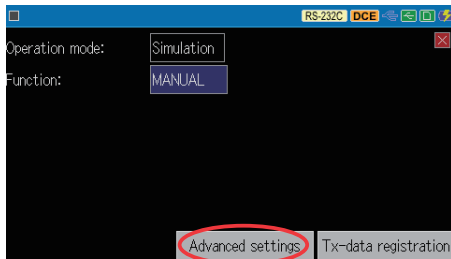

Press [MENU] and touch "Operation mode: Simulation"->"Function": MANUAL".

Touch "Advanced settings" in the bottom of screen.



Set the following items below.

Items	Description	Range of Selection
DELAY TM	Space between characters	0 to 99999 1msec. unit
REPEAT	Repetitive transmission of frame	ON( <input checked="" type="checkbox"/> ) /OFF( <input type="checkbox"/> )
IDLE TM	Interval of repeat transmission	0 to 99999 1msec. unit

-  Delay time setting is valid only for ASYNC and ASYNC (PPP). For other protocols, always set "0" for delay time.
-  Even though delay time is set "0", the analyzer needs some time to process.

Press [RUN] and it will be in a wait state till a key corresponding to the transmission data table is entered.

□ When the analyzer is DTE mode

After starting the measurement, RTS and DTR become active. If using the Auto signal control, RTS and DTR change their status according to the setting.

 4.3 Auto Line Control

Entering a data table number (0-F) makes registered data corresponding to the data table transmitted. The data group of data table can be changed by [SHIFT] + [▶] or [SHIFT] + [◀] Press [SHIFT] + [0]~[D] to send a fixed data table. Press [SHIFT] + [E]/[F] to change control lines (RTS/DTR) ON/OFF.

The respond data will be displayed on the RXD line. It is able make a protocol flow, checking the transmission and reception data.

□ When the analyzer is DCE mode

After starting the measurement, CTS, DSR and DCD become active. If using the Auto signal control, DCD and CTS change their status according to the setting. Transmission data is displayed in the RXD line and respond data will be displayed on the TXD line. Press [SHIFT] + [E]/[F] to change control lines (CTS/DCD) ON/OFF.

In the right figure, it transmits “ENQ” by pressing [SHIFT]+[0]. When receiving “ACK”, it transmits data table 3 (SxABCDEFGH Ex BCC) by pressing [3]. When receiving “ACK”, it transmits “EOT” by pressing [SHIFT]+[4].

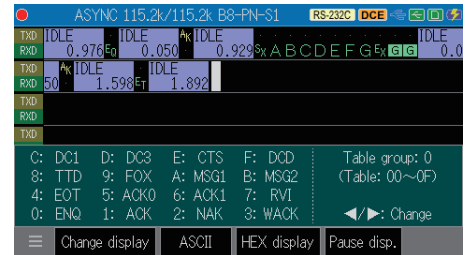

■ Break (ASYNC mode only)

Press [END/X] to send a break (active status “0”) for a period of 12 bit. “B” will be displayed on the screen.

■ Continuous operation

If a new data send table is transmitted while it has been transmitting previous transmission data table, it will finish the previous one first, then send the next table.

It is able to change the control lines by [SHIFT] + [E]/[F] during the transmission of data tables.

■ Repeat transmission

When ON is set to “REPEAT”, data corresponding tables will be transmitted continuously spacing idle time. To stop this operation, press [TOP/DEL] or select a data table with no data.

Press [STOP] to finish testing.

## 4.5 Buffer Mode

Buffer simulation is the mode to send data of the TXD or RXD side recorded in the capture buffer. Therefore, it can reproduce the communication of data monitored.

### Preparation

Select the recording area from “BUF1” or “BUF2” which is the half of capture memory.

Monitor communication data and perform a reproducing test in the Buffer mode.

Monitor data and save data in the “BUF1” (or “BUF2”).

To prevent data from overwriting, mark on the box of “Protection”.

Change the recording area to another half of buffer, “BUF2” (or “BUF1”).

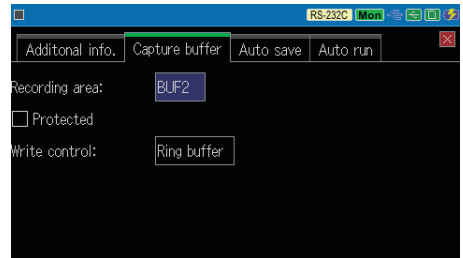

2.5 Communication Condition

2.6 Record Control ( Dividing a Capture Buffer)

Buffer simulation is not going to start if it selects “BUF0”.

### Setting

Press [MENU] and touch “Operation mode: Simulation”->“ Function”: BUFFER”.

Touch “Advanced settings”.

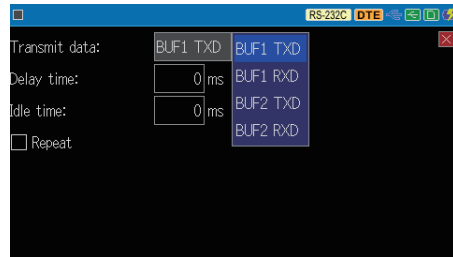
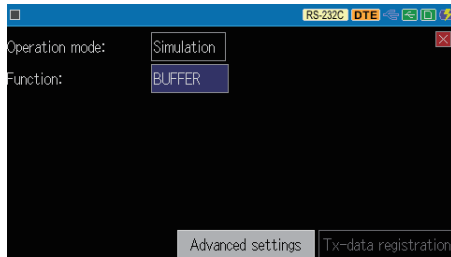

Set the flowing items below.

Items	Description	Range of Selection
Transmission Data	BUF1RD:Data side of TXD	BUF1 TXD
	BUF1RD:Data side of RXD	BUF1 RXD
	BUF2RD:Data side of TXD	BUF2 TXD
	BUF2RD:Data side of RXD	BUF2 RXD
DELAY TM	Space time between characters	0~99999ms 1msec. unit
Repeated transmission	Appointing repetitive transmission	ON( <input checked="" type="checkbox"/> ) / OFF( <input type="checkbox"/> )
IDLE TM	Space time between frames	0~99999 1msec. unit

To send data in the TXD, select DTE mode. To send data in the RXD, select DCE mode. Set the conditions of analyzer as same as the condition of monitored data.

2.3 Measurement Port

2.5 Communication Condition

If the condition of analyzer is not same as the condition of monitored data, the result of this testing may not be accurate.

## Operation

Press [RUN] and data in the selected buffer on the TXD or RXD will be transmitted from the oldest data. Data is transmitted by one frame unit continuously spacing "Idle time".

### ◆ Limitation of operation

- If one frame contains more than 4K characters, analyzer divides its data and sends the first 4K characters.
- Framing error of ASYNC is transmitted as normal data. (not as error)
- Aborted frame of HDLC/SDLC is not transmitted but a flag is transmitted in the place where aborted frame is generated.
- Information of Idle time in the buffer is not going to be used.
- Information of control line in the buffer is not going to be used. When the analyzer is DTE mode, RTS and DTR will be in an active state at the beginning of test. And, when the analyzer is DCE mode, CTS, DSR and DCD will be in an active state.

Press [STOP] to stop transmission and simulation.

## 4.6 Flow Mode

In the flow control test, the analyzer works as a transmitter or a receiver. It can simulate flow control signals such as X-ON/X-OFF characters and handshake of control line.

## Setting

Before starting the Flow simulation, set protocol and communication conditions in the "Configuration", and register transmission data in the data table.

-  2.5 Communication Condition
-  4.1 Register Transmission Data

Press [MENU] and touch "Operation mode: Simulation" -> "Function": FLOW".

Touch "Advanced settings" in the bottom of screen.

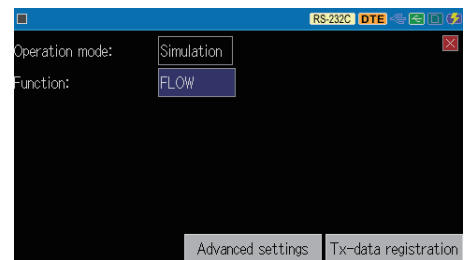

### ■ Test Mode

Select "Send test" if analyzer becomes the transmitter. Select "Receive test" if analyzer becomes the receiver.

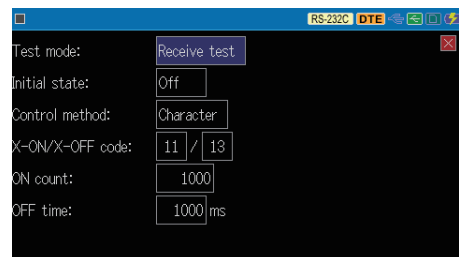
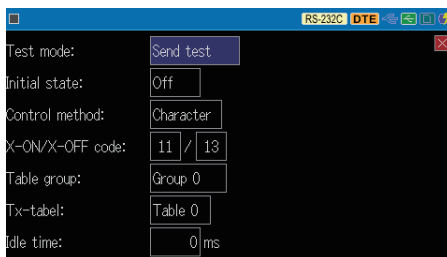

### ■ Initial state

Initial state of flow control at the beginning of test.

- OFF : Prohibit transmission
- ON : Allow transmission

### ■ Control method

Select the control method.

- Character : X-ON/X-OFF character
- Line : Handshake of control line

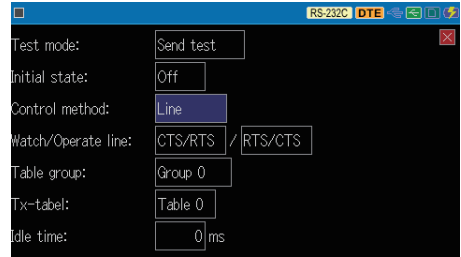

### ■ X-ON/X-OFF code

Set X-ON/X-OFF character in HEX. Normally, you do not have to change the initial value.

### ■ Watch/Operate line

Set a pair of control line to allow transmission and request transmission. A pair of RTS and CTS is mostly used.

### ■ Table group (for “Send test”)

Select a group of transmission data table.

### ■ Tx-table (for “Send test”)

Select a transmission data table.

### ■ Idle time (for “Send test”)

Select the idle time. (0 to 9999ms)

### ■ ON count (for “Receive test”)

The number of a reception character until interruption request is transmitted. (1~999999)

### ■ OFF time (for “Receive test”)

Time between interruption request and re-transmission request. (0 to 9999ms)

## Operation

---

Press [RUN] to start the flow control test.

### ○ “Send test” with X-ON/X-OFF flow control

- 1) When the analyzer is DTE mode, RTS and DTR will become active. When the analyzer is DCE mode, CTS, DSR and DCD become active.
- 2) If the initial state is “ON”, it will start the data transmission immediately. If the initial state is “OFF”, it will start the transmission after receiving the X-ON character.
- 3) Transmission is interrupted when it receives X-OFF character. And transmission is re-started when it receives X-ON character.

### ○ “Send test” with handshake flow control

- 1) When the analyzer is DTE mode, RTS and DTR will become active. When the analyzer is DCE mode, CTS, DSR and DCD become active.
- 2) Transmit selected data table repeatedly while the selected control line at “Watch/Operate line” is active. Transmission is interrupted when the selected control line is non-active. When the analyzer is DTE mode, CTS (or DCD) set at “Watch/Operate line” is used. When the analyzer is DCE mode, RTS (or DTR) set at “Watch/Operate line” is used.

During “send test”, the number of data transmitted from starting to interrupting data transmission will be displayed on the screen for sixteen times.

(When it is over 999999, the message “OVER” will be appeared.)

- ☰ There might be some data transmitted after having the interruption of data transmission.

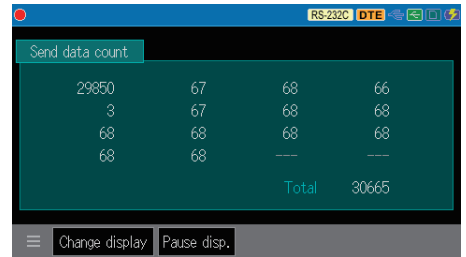

○ “Receive test” with X-ON/X-OFF flow control

- 1) When the analyzer is DTE mode, RTS and DTR will become active. When the analyzer is DCE mode, CTS, DSR an DCD become active.
- 2) If the "Initial state" is “ON”, it will start the data transmission immediately. If the "Initial state" is “OFF”, it will start the reception after the period of “OFF time” and receiving X-ON character.
- 3) Transmit X-OFF character when it receives data is reached to the number set at “ON count”. And transmit X-ON character when it passes the time set at “OFF time”.

○ “Receive test” with handshake flow control

- 1) If the “Initial state” is “ON”, it will make the selected control line active immediately. If the "Initial state" is “OFF”, it will make the selected control line active after the period of “OFF time”. When the analyzer is DTE mode, RTS (or DTR) is used. When the analyzer is DCE mode, CTS (or DCD) is used.
- 2) It makes the selected control line active when number of received data reaches to the number set at “ON count”. And it makes the selected control line non-active after the period of “OFF time”.

During “Receive test”, transmission/reception data are displayed on the screen at real time.

Press [STOP] to end the test.

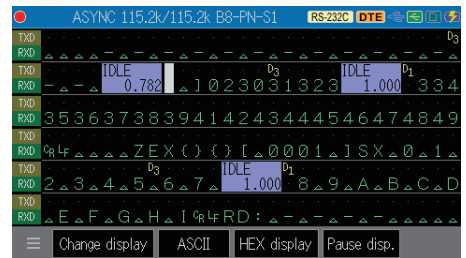

## 4.7 Echo back test (ECHO mode)

The echo back test is the function that makes received data repeatedly transmitted from the analyzer.

 This function cannot be used if protocol is set to I2C, SPI or Burst at "Configuration" setting.

 2.5 Communication Condition

### Setting

Press [MENU] and touch "Function" → "Operation mode: Simulation" → "Function: ECHO".

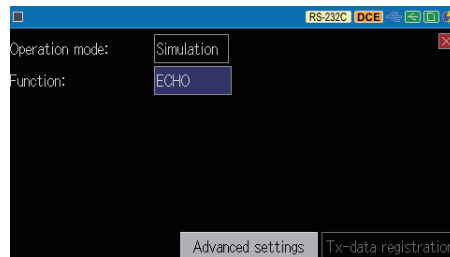

Touch "Advanced settings" in the bottom of screen.

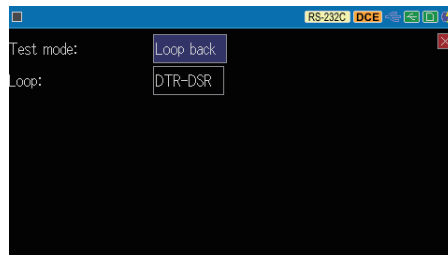
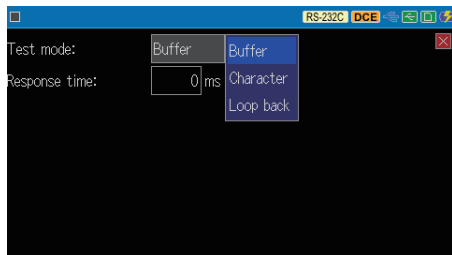

#### ■ Test mode

**Buffer** : Return the received frame with the time interval set at "Response". (0 to 99999ms)

 10.3 About the Frame

**Character** : Return the received frame after receiving a character.

**Loop-back** : Loop back the signals of TXD-RXD, RTS-CTS, ST1-RT, or selected control line at "Loop" (DTR-DSR or DTR-DCD).

 "Character" is valid only for ASYNC protocol set at "Configuration" setting.

Press [RUN] to start the loop-back test.

■ Buffer

Return the received data per a frame according to the "Con-figuration" setting.

- ☞ If it receives a new frame while it is in the "Response time" after receiving 1 frame, it can record max. 255 frames.
- ☞ The actual response time may be longer than selected "response time".

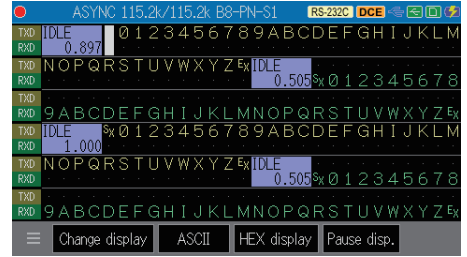

■ Character

Return the received data after receiving a character with data bit and Parity/MP bit. Data with framing error will be returned as normal data. (not as error)

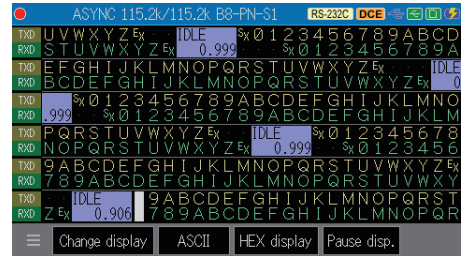

■ Loop-back

Loop back the signals in the hardware of analyzer according to the "Interface" setting.

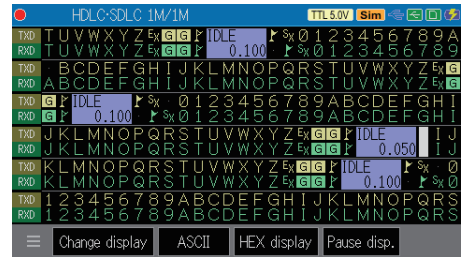

Loop-back route:

For RS-232C and RS-530 (optional interface board OP-SB10N)

DCE (DSUB25pin)	DTE (DSUB25pin)
SD → connected in internal circuit	RD → connected in internal circuit
RTS → connected in internal circuit	CTS → connected in internal circuit
DTR → connected in internal circuit	DSR*1 → connected in internal circuit
	DCD*1 → connected in internal circuit
ST1 → connected in internal circuit	RT → connected in internal circuit

\*1:The pair of control lines selected at "Loop".

For RS-422/485

DCE (Terminal 5pin)	DTE (DSUB25pin)
TXD +- → connected in internal circuit	RXD+- → connected in internal circuit
	TXD +- → connected in internal circuit

☞ In this case, full-duplex connection is used, so set "Driver control" in the interface settings to "Off".

For TTL

DCE (TTL connector)	DTE (TTL connector)
TXD → connected in internal circuit	RXD → connected in internal circuit
RTS → connected in internal circuit	CTS → connected in internal circuit

## 4.8 Polling mode

In the polling mode, analyzer works as a slave station or a master station. And it replies message or analyzes the response when data corresponding to each situation is transmitted or received.

- 📄 If the target is RS-485 half-duplex communication, check “Half-duplex simulation” in the interface settings to distribute the send and receive data.
- 📄 Cannot be used with half-duplex communication using TTL ports such as I2C.

### Setting

Before starting the polling simulation, set protocol and communication conditions in the “Configuration”.

#### 📖 2.5 Communication Condition

Press [MENU] and touch "Function" -> “Operation mode: Simulation”->“ Function: POLLING”.  
Touch “Advanced settings ” in the bottom of screen.

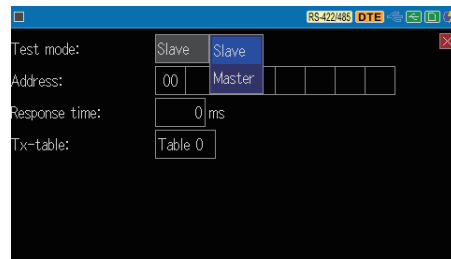
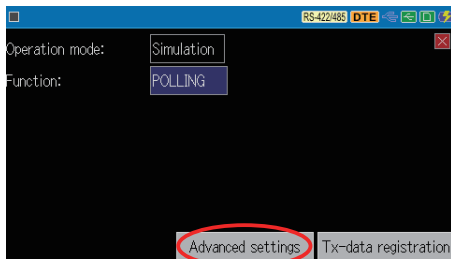

### Slave mode

In the slave mode, analyzer works as a slave station. When a station address is received, response message will be returned.

#### ◆ Set following conditions

Item	Description	Range of Selection
ADDRESS	Station Address	Within eight characters in HEX
RESPONSE	Delay Time	0 to 99999 1msec. unit
TABLE No	Transmission Table No	0 to F

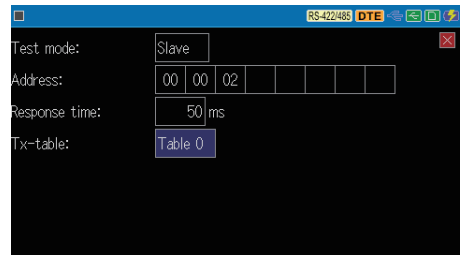

Address : Set a station address of analyzer.

Response : Set a delay time between receiving a message and sending a response message.

Table No. : Select a transmission data table registered a response message.

- 📄 Register a response message in the transmission data table Group 0.

#### 📖 4.1 Register Transmission Data

<Operation>

- 1) Press [RUN], and control line (RTS/CTS for DTE mode. CTS/DSR/DCD for DCE mode) become active.
- 2) When a message is arrived, it searches a data sent to self-station address.
- 3) If there is no message to self-station, it waits for a next message.

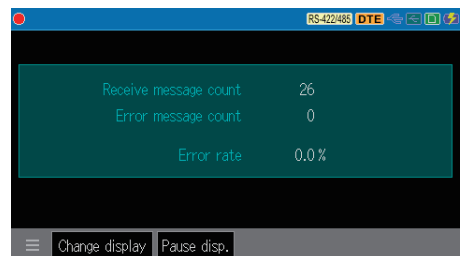

4) When there is a message to self-station, it receives the message. And then, response message will be returned after response time.

When a message to self-station is received, error check will be executed.  
(Even if there is an error, only message being set will be returned as a response message.)

Protocol	Description of Error Checking
ASYNCR	Parity Error, Framing Error, BCC Error
SYNCR • BSC	Parity Error, BCC Error
HDLC • SDLC	FCS Error

5) Repeat the process from .

Following is displayed on the result screen

The number of the received message	The number of the received messages to self-station.	0~99999
The number of error messages	The number of the received messages including errors	0~99999
Error rate	The generating rate of the error messages	0.0 ~ 100%

## Master mode

In the master mode, analyzer works as a master station. And it transmits a polling message to each station address, and analyzes returned data.

### Response time

Set the time between receiving a message from slave station and sending a response message.

### Time -out time

Set the timeout time when there is no response from a slave station. (0~9999ms)  
Set 0 to make no waiting time.

### Repeat count

Set the number of times to execute polling test. (0~9999 times)  
Set 0 to repeat continuously until [RUN] key is pressed.

### Polling message

Set a polling message to transmit from analyzer (master station). Up to 15 characters in HEX can be set including don't care "\*" entered with [END/X]. And slave station address will be added to the position where don't care "\*" is entered in order of the minimum station number. To register slave station address, touch "station address" in the bottom of screen.

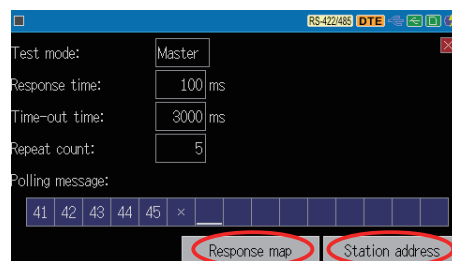

◆ Response map

Touch “Response map” on the bottom of screen. Set a response of slave station for polling message and how the analyzer operates by its response.

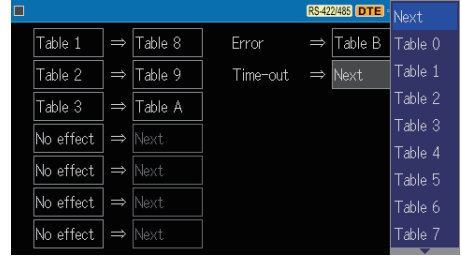

[A ⇒ B]

A : Set a transmission data table No. which is data compared with response message from slave station.

B : Set a transmission data table No. to send from the analyzer when response message from slave station matches A's contents.

📖 In A, data registered in the transmission data table will be used as data compared with response message data. In this time, from the 1st to 23rd character of registered data will be effectively compared data.

[Error ⇒ X]

When communication errors are generated in response message from slave station, selected transmission data table will be transmitted from the analyzer.

Protocol	Description of Error Checking
ASYNC	Parity Error, Framing Error, BCC Error
SYNC·BSC	Parity Error, BCC Error
HDLC·SDLC	FCS Error

[Time-out ⇒ X]

When waiting time for response (timeout) from slave station is passed, selected transmission data table will be transmitted from the analyzer.

- When “Next” is selected in B or X, it transmits nothing and polling will be executed to next slave station.
- When transmission data table is selected in B or X, the analyzer will be in a wait state for response from the same slave station.

📖 4.1 Register Transmission Data

◆ Station address

Touch “Station address” on the bottom of screen and set the slave station address to insert in polling message. Max. 8 characters for one slave station address and 32 kinds of address can be set in HEX. Touch the tab or target slave address, or press [▲],[▼]to select different slave address.

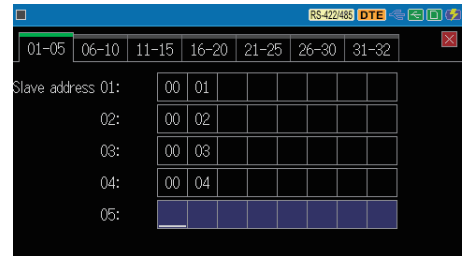

📖 Slave station address is inserted to polling message in order of the minimum station No.

📖 If nothing is registered in the slave station address, that station number will be ignored.

- <Operation> 1) Press [RUN] and control lines (RTS/CTS for DTE mode. CTS/DSR/DCD for DCE mode) become active. And then, polling simulation starts.
- 2) It operates corresponding to setting conditions and response from slave station like below.

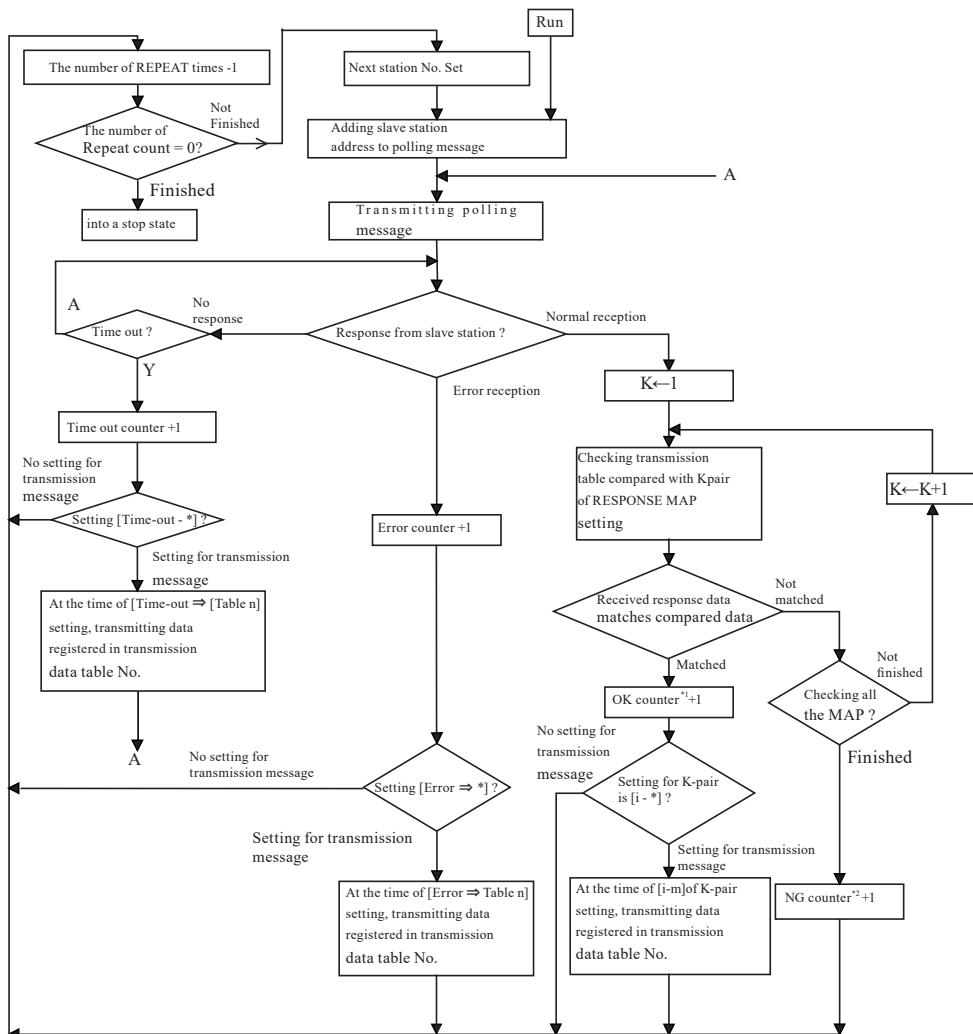

\*1:Counter for OK-message. \*2:Counter for NG-message.

- 3) It displays the result of each slave station. Swipe the screen or press [▲],[▼] to display all data.

Touch “Change display” to go back to normal monitored data display.

No.	OK message	NG message	Error	Time out
01	5	0	0	0
02	5	0	0	0
03	5	0	0	0
04	4	0	0	4
05	0	0	0	0
06	0	0	0	0
07	0	0	0	0
08	0	0	0	0
09	0	0	0	0
10	0	0	0	0
11	0	0	0	0

Change display Pause disp.

OK message : The number of received times for response message from slave station which matches compared data of response map.

NG message : The number of received times for response message from slave station which does not match compared data of response map.



Error : The number of received times for response message with communication errors.

Time out : The number of times of timeout generated.

## 4.9 Program mode



---

In the program simulation function, a simple program can be made by command-selected programming system. And transmission/reception sequences through each protocol are flexibly simulated.

-  If the target is RS-485 half-duplex communication, check “Half-duplex simulation” in the interface settings to distribute the send and receive data.
-  When using half-duplex communication using a TTL port such as I2C, commands related to received data such as WAIT CHR and WAIT FRM cannot be used.

### Outline

---

- **Program**  
4 kinds (A~D) of the programs can be made.
- **Program Steps**  
Up to 512 instruction steps for one program can be made.
- **Number of Command**  
There are 37 kinds of the commands with the combination of commands and sub-commands. The destination linked with the command can be labeled. Therefore, modifying a program can be easily executed.
- **Register**  
16 kinds of register (“REG 0”~“REG F”) are provided in the range of 0 to 999999.
- **Data Array**  
100 kinds of data array (“DA 00”~“DA 99”) can be made. Up to 8 characters can be recorded in each data array. Specify the data array No. by register value and compare reception data with data array.
- **Transmission data table**  
Register transmission data table before starting the program simulation used for SEND TBL command and IF TBL command.  
 4.1 Register Transmission Data
- **Timer**  
There are 2 kinds of timers, “TM 0” and “TM 1” used for IF TM command (timeout program) and SET TM command (start/stop command). Set the unit of this Timer from [MENU]->“Trigger”->“Timer/Counter setting”.  
Besides these timers, a timer which purpose is exclusively to control the program halt within a limit of 9.999 sec (with fixed unit of 1msec) is provided for use with the WAIT TM command.  
 6.2 Timer/Counter Function
- **Counter**  
There are 2 kinds of counters, “CT 0” and “CT 1” used for IF CT command (count program) and SET CT command (count up/clear operation).  
Set the unit of this Timer from [MENU]->“Trigger”->“Timer/Counter setting”.  
 6.2 Timer/Counter Function
- **Frame Buffer**  
A buffer memory exclusively used for recording received data in the unit of a frame (max. 4096 bytes) for WAIT FRM command. It is used to compare received data by IF TBL command.
- **Trigger condition**  
Before setting the commands of INT TRG0, WAIT TRG and IF TRG, set the trigger conditions from [MENU] -> “Trigger” -> “Trigger factor”.

-  Only “Trigger factor” is used and “Trigger action” and invalid/valid of trigger are not used.

 6.1 Trigger Function

Before starting the Program simulation, set the protocol and communication conditions in the “**Configuration**”.

Press [MENU] and touch “**Function**” -> “**Operation mode: Simulation**” -> “**Function: PROGRAM**”.

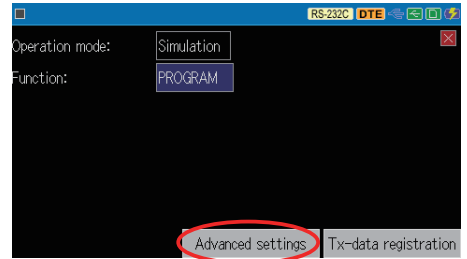

Touch “**Advanced settings**” in the bottom of screen. Select one program from Program A~D and touch “**Edit**”.

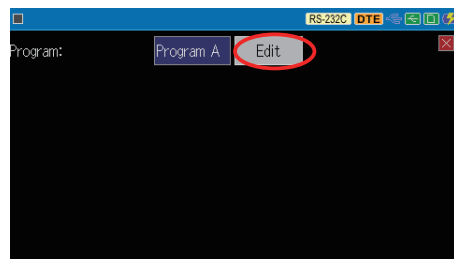
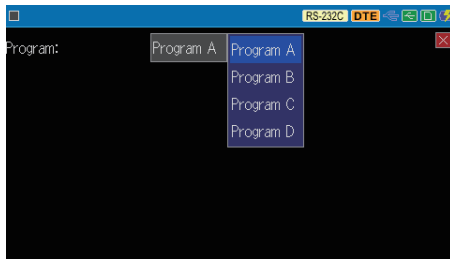

At the beginning, NOP commands (invalid command) are inputted in all 512 lines. The cursor is on the first line, 000. To move the cursor, swipe the screen or press [▼],[▲]. To input the command, touch desired command on the right part of the screen or press [0]~[F].

- ☰ Press [SHIFT]+[▼] or [SHIFT]+[▲] to go to another page (move 6 lines).
- ☰ Press [SHIFT]+[TOP/DEL] to go to the first page, or [SHIFT]+[END/X] to go to the last page.

○ Input Method

◆ Command Field

Touch or press [0]~[C] to select a desired sub-command (SEND, WAIT, IF commands etc.) or [TOP/DEL] to delete commands. After deleting a command, the following commands comes up instead and NOP command is added at the end.

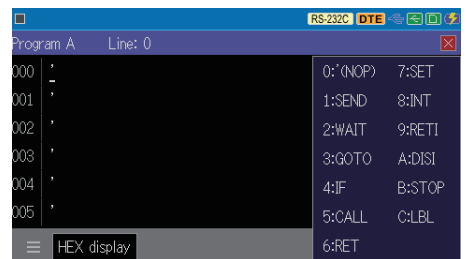

◆ Sub-Command Field

After the command field is entered, the cursor moves to the sub-command entry field. Desired sub-commands will be displayed in the right side of the screen. Touch or press [0]~[7] to select a desired sub-command. To edit the sub-command, move the cursor to the sub-command field by [▶] [◀] and edit.

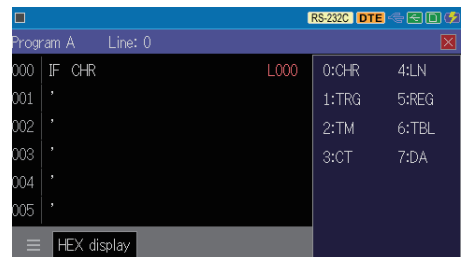

### ◆ Operand Field

After the sub-command is entered, the cursor moves to the operand field. Desired operands will be displayed in the right side of the screen. Touch or press [0]~[F] to select a desired operand. To edit the operand, move the cursor to the operand field by [◀] [▶] and edit.

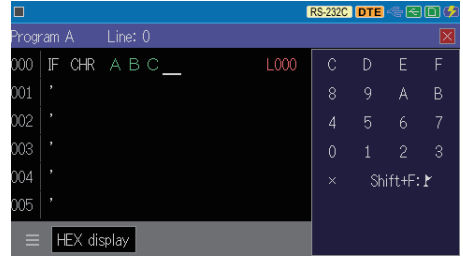

### ○ Save program

Inputted programs A~D will be saved in the SRAM with a battery. Moreover, it will not be erased after turning off the power of analyzer. To save more programs, use the storage device and save them as setting data files.

📄 When the analyzer reads setting data files, program A~D will be overwritten.

## 📖 8.2 File Management Function

## 📖 Operation

Press [RUN] and program A~D will be executed from line 000.

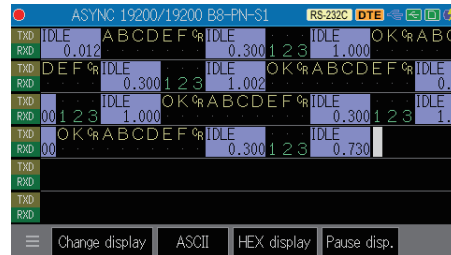
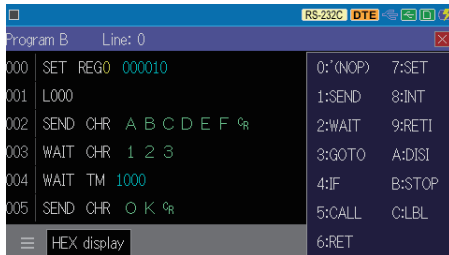

Send commands and received data from target device are displayed on the screen. It is able to analyze the protocol and sequence of transmission and reception.

Touch “☰” to check the timer/counter or register value.

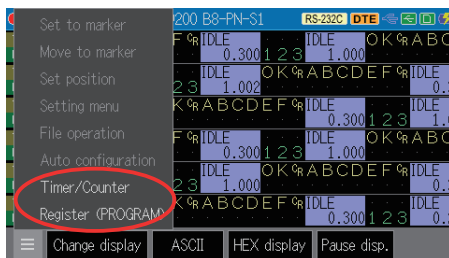

📄 Amount of traffic and speed of communication changes the delay time between commands.

Press [STOP] and a running program will stop. Also, when the STOP command is executed, it will stop.

## 4.10 Commands for Program Mode

No	Command	Operation
0	NOP	No Operation. Go to next step.
1	SEND CHR □□□□□□□□	Data communications up to 8 characters.
	SEND TBL □□	Data transmission of the specified data send table.
	SEND REG □ GRP □	Data communications of the transmission data table specified by a register value.
	SEND BUF	Transmits data in the frame buffer.
	SEND KEY GRP □	Transmits data in the transmission data table corresponding to keystroke.
	SEND DA □□+REG□	Transmits data of the data array specified by additional value of preset value of the data array number and the value specified by register number.
	SEND BRK	Transmits a break. (ASYNC mode only)
2	WAIT CHR □□□□□□□□	Waits for the particular character string of up to 8 characters to be received.
	WAIT FRM (CLR/NOCLR)	Waits for a frame to be received.
	WAIT TRG □	Waits for a specified trigger condition to be specified.
	WAIT TM □□□□	Waits for a specified period of time.
	WAIT KEY	Waits until one of the keys from [0] to [F] is pressed.
	WAIT LN □=□	Waits until the logical values of the control lines meet with the setting.
3	GOTO L□□□	Jumps to a specified label number.
4	IF CHR □□□□□□□□ L□□□	Branches to a specified label number if the particular character string is included in the frame buffer.
	IF TRG □ L□□□	Branches to a specified label number if the trigger conditions are satisfied.
	IF TM □ L□□□	Branches to a specified label number if the timer exceeds the setting value.
	IF CT □ L□□□	Branches to a specified label number if the counter exceeds the setting value.
	IF LN □=□ L□□□	Branches to a specified label number if the logic values of control lines meet with the setting.
	IF REG□ □ REG□ L□□□	Branches to a specified label number if the inequality relation between registers is satisfied.
	IF TBL□□ L□□□	Branches to a specified label number if it is satisfied with data of table specified by the table number.
	IF DA □□+REG □ L□□□	Branches to a specified label number if the specified value of a data array number is same as the sum of the value of data array specified in the register number.
5	CALL L□□□	Jumps to a subroutine marked with a specified label number.
6	RET	Returns from the subroutine.
7	SET REG □ □□□□□□□	Sets a value to register, or increments or decrements the register.
	SET LN □=□	Sets a value of the control line.
	SET TM □ □□□□□□□	Sets a value to the timer, or controls the start, the stop or the restart of the program.
	SET CT □ □□□□□□□	Sets a value to the counter, or increments or resets the counter.
	SET BZ	Sets the buzzer.
	SET OUT	Outputs a pulse to the trigger out terminal.
	SET DA □□ □□□□□□□□	Sets data to the data array.
	SET DV □□ REG□ □	Sets the specified number of characters on contents in register as a character string to the data array.
8	INT TRG 0 L□□□	Jumps to the subroutine marked by the specified label number when the condition of trigger 0 is satisfied.
9	RETI L□□□	Returns from subroutine started by the INT command.
A	DISI TRG 0	Disables an interruption.
B	STOP	Stops the running of simulation operation.
C	L□□□	Enters a label number in a range from 0 to 999 in decimal notation.

## NOP Command (Invalid Command)

The NOP command, which is displayed as “,” is the command that has no impact on the program execution.

<Entering>

Cursor Position	Enter & Operation
Command Field	0
Sub-Command Field	-
Operand Field	-

<Operation>

- When the program is running, the NOP command is ignored and the instruction of the next line number is executed.

## SEND Command (Data Transmission Command)

The SEND command is used to transmit data from your analyzer.

### 1) SEND CHR □□□□□□□□ (Character Line Transmission Command)

<Entering>

Cursor Position	Enter & Operation
Command Field	1
Sub-Command Field	0
Operand Field	Enter a string of up to 8 characters in hexadecimal code. To enter a string of less than 8 characters, finish the entry by pressing [▼] and proceed to the next line.

<Operation>

- The character string which is set in the operand field is transmitted. Use this command to transmit a short character string.
- Each protocol has different way of transmission. Refer to following table.

MODBUS: Add BCC code automatically for RTU mode and transmit.

Operand Field: Specify the table group in the 1st digit, and the table No. in the 2nd digit with 00~9F.

Protocol	Contents of Data Transmission
ASYNC	If the character string for transmission includes BCC calculation start and stop characters, the BCC code is inserted and transmitted automatically.
SYNC • BSC	The SYNC character and the RST character are automatically inserted to data and transmitted. In addition, if the character string for transmission includes BCC calculation start and stop characters, the BCC code is added automatically.
HDLC • SDLC	The flag and the FCS code are automatically inserted to data, and are transmitted.
ASYNC-PPP	If transmission data forms a frame, the FCS code is automatically inserted and transmitted.
MODBUS	Add BCC code automatically for RTU mode and transmit.

### 2) SEND TBL□□ (Data Table Transmission Command)

<Entering>

Cursor Position	Enter & Operation
Command Field	1
Sub-Command Field	1
Operand Field	Specify the table group in the 1st digit, and the table No. in the 2nd digit with 00~9F.

<Operation>

- Data, which is in the transmission data table on the number being set in the operand field, is transmitted. Use this command to send multi character strings.

 4.1 Register Transmission Data

### 3) SEND REG□ GRP□ (Register-Specified Data Table Transmission Command)

<Entering>

Cursor Position	Enter & Operation
Command Field	1
Sub-Command Field	2
Operand Field	Enter a register number with [0] to [F] keys and a table group number with [0] to [9] keys. By [END/X]:* (Don't care), all the groups will be the target.

<Operation>

- The transmission data table No. is specified with the register value 0 to 15 (F) being set in the operand field. And data with that number will be transmitted. The target table group number 0 to 9 is also set in the operand field. When the register value is over 16, remained transmission data table after dividing by 16, is specified.
- When “\*” is set to a table group, it directly selects by the register value (0 to 159). In this case, when register value is over 160, the remained value divided by 160 will be applied.
- If data without setting any data table is specified, no data is transmitted. Then, the next instruction will be executed.

#### 4) SEND BUF (Frame Buffer Data Transmission Command)

<Entering>

Cursor Position	Enter & Operation
Command Field	1
Sub-Command Field	3
Operand Field	-

<Operation>

- Data stored in the frame buffer is transmitted.
  - If no data is stored in the frame buffer, the next instruction is executed without sending any data. Before it is executed, the WAIT FRM command is required to execute in order to store data in the frame buffer.
-  Cannot send framing error, break or abort as itself.

#### 5) SEND KEY GRP□ (Key-Specified Data Table Transmission Command)

<Entering>

Cursor Position	Enter & Operation
Command Field	1
Sub-Command Field	4
Operand Field	Enter a table group number by 0 to 9 keys.

<Operation>

- It waits until you press a key ([0] to [F]) and when you press the key it transmits the data of the transmission data table of the table group specified in the operand field. (The data to be transmitted corresponds with the key number you press.)
- When you specify a data table at which no data is set, it does not transmit data. Then it executes the next instruction.

#### 6) SEND DA□□+REG\* (Data Array Transmission Command)

<Entering>

Cursor Position	Enter & Operation
Command Field	1
Sub-Command Field	5
Operand Field	Enter two digits of a data array number with the key, 0 to 9.
	Enter a register number with the key, [0] to [F]. Offset cannot be set by [END/X]: “*” (don't care).

<Operation>

- The Data array is set for the data array number in the operand field. And register value, which is set for the register number, is added as an offset value to that data array. After that, that value is as a data array number. And corresponding data of data array will be transmitted. If the result of the addition includes three digits, its last two digits are as data array numbers and corresponding data of data array is transmitted.
- When “\*” is set for a register number, data of the data array specified by the data array number is transmitted. If the “SEND DA xx” command is entered continuously, data registered in the data array is connected and transmitted. In this case, the size of transmission data is up to 1Kbytes. When it exceeds 1Kbytes, the excess of data will be omitted.
- If no data is registered in the data array set to the data array number, any data is not transmitted. And the next command is executed.
- Transmission data depends on the selection which is made on the Protocol as the “SEND CHR” command.

- Ex.) Transmit the contents (ABC) on DA33.  
 000: Set 41h, 42h, 43h in HEX to DA33.  
 001: Set 10 to REG4.  
 002: Add DA number 23 and REG4 value 10 and send data.

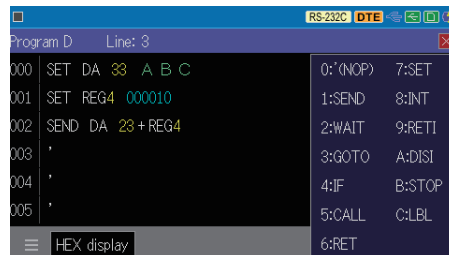

- Ex.) Connect data from DA00 to DA02 and transmit (ABCDEFGH)  
 000: Set 41h, 42h, 43h in HEX to DA00.  
 001: Set 44h, 45h, 46h in HEX to DA01.  
 002: Set 47h, 48h, 49h in HEX to DA02.  
 003: The“SEND DA” commands are entered continuously.  
 004: Data registered in the DA 00 to 02 are connected.  
 006: Transmit ABCDEFGHI.



### 7 ) SEND BRK (Break Transmission Command)

<Entering>

Cursor Position	Enter & Operation
Command Field	1
Sub-Command Field	6
Operand Field	-

<Operation>

- Transmits a break. (ASYNCR mode only)

### ◆ Data transmission and next command

When the SEND command is executed, it will start the command immediately before completing the previous data transmission. Set the WAIT FRM command (waiting for 1 frame) after SEND command as a response of transmitting data to read data in the frame buffer.

Ex.) SEND TBL 00  
 WAIT FRM CLR

Some of the commands (such as new SEND, SET LN, SEND commands) cannot transmit data until finishing the previous data transmission. In this case, the program becomes a wait status.

## WAIT Command (Command to Halt Program Execution)

The WAIT command is used to halt the execution of a program until the particular conditions are satisfied.

 If the “INT TRG” command interrupts this command, a wait state is canceled.

### 1 ) WAIT CHR□□□□□□□□ (Command to Wait for Character Reception)

<Entering>

Cursor Position	Enter & Operation
Command Field	2
Sub-Command Field	0
Operand Field	Enter a string of up to 8 characters in hexadecimal code. To enter the string of less than 8 characters, finish the entry by pressing ▼ and proceed to the next line. Additionally, “Don’t Care” (*) and a flag ( [SHIFT] + [F] ) are acceptable.

<Operation>

- Your analyzer halts the program control until the specific character string, which is previously set in the operand field, is received.
- When “Don’t Care” is set, your analyzer halts the program control until some character is received (This command does not use frame buffer).



5 ) WAIT KEY (Command to Wait for Key Stroke)

<Entering>

Cursor Position	Enter & Operation
Command Field	2
Sub-Command Field	4
Operand Field	-

<Operation>

- Your analyzer halts the program control until one of the numerical keys from [0] to [F] is pressed. Whatever key is pressed down, the result is the same.

6 ) WAIT LN□=□ (Command to Wait for Meeting Control Line)

<Entering>

Cursor Position	Enter & Operation
Command Field	2
Sub-Command Field	5
Operand Field	Select signals from 0:RTS, 1:CTS, 2:DSR, 3: DCD, 4:DRT, 5: RI, 6:TRG. Select status from 0: non-active, or 1: active.

<Operation>

- Program control waits until the logic values of the control lines meet with the setting.

 GOTO Command (Designated Label Number Branch Command)

The GOTO command branches the program control unconditionally to designated label number.

GOTO L□□□

<Entering>

Cursor Position	Enter & Operation
Command Field	3
Sub-Command Field	-
Operand Field	Enter a label number in three digits decimal figures with the key, [0] to [9].

<Operation>



- The program control branches to the instruction marked with the label number specified in the operand field.

 IF Command (Conditional Comparison Branch Control)

The IF command branches the program control to the designated label number if the particular conditions are satisfied. Or, it processes the next instruction if they are not satisfied.

1 ) IF CHR□□□□□□□□ L□□□ (Received Character Comparison Command)

<Entering>

Cursor Position	Enter & Operation
Command Field	4
Sub-Command Field	0
Operand Field	Enter a character string of up to 8 characters in hexadecimal code. To enter a string of less than 8 characters, finish the entry by pressing  and move a cursor to the label entry section. Additionally, [END/X] “Don’t Care” (*) and a flag (  ) [SHIFT]+[F] are acceptable. Enter a label number in three digits decimal figures with the key, 0 to 9.

<Operation>

- WAIT FRM command searches the data in the frame buffer. And if the character string specified in the operand field is found, the program command branches to the designated label No.

2 ) IF TRG□ L□□□ (Judgment Command to Check Satisfaction of Trigger Conditions)

<Entering>

Cursor Position	Enter & Operation
Command Field	4
Sub-Command Field	1
Operand Field	Enter a trigger number with the key, [1] to [3] (Trigger 0 is not selectable).
	Enter a label number in three digits decimal figures with the key, [0] to [9].

<Operation>

- The program control branches to the designated number if the conditions for the Factor of the trigger specified in the operand field are satisfied.
- Only trigger factors 1~3 are used. Other information such as trigger valid/invalid and trigger action are not used.

Factor	Judgment Contents
Error	Data in the frame buffer is checked to see if the conditions are satisfied.
Character	
Line state	The conditions are checked to see if it is satisfied when the command is executed.
Timer/Counter	Does not perform anything. The next command is executed unconditionally.
Idle time	The conditions are checked to see if it is the condition value or over when the command is executed.

 6.1 Trigger Function

3 ) IF TM□ L□□□ (Judgment Command on Timer)

<Entering>

Cursor Position	Enter & Operation
Command Field	4
Sub-Command Field	2
Operand Field	Enter a timer number with the key [0] or [1].
	Enter a label number in three digit decimal figures with the key, [0] to [9].

<Operation>

- The program control branches to the designated label No. if the value of the timer No. specified in the operand field is over the preset value.

 6.2 Timer/Counter Function

4 ) IF CT□ L□□□ (Judgment Command on Counter)

<Entering>

Cursor Position	Enter & Operation
Command Field	4
Sub-Command Field	3
Operand Field	Enter a counter number with the key [0] or [1].
	Enter a label number in three digit decimal figures with the key, [0] to [9].

<Operation>

- The program control branches to the designated label No. if the value of the counter No. specified in the operand field is over the preset value.

 6.2 Timer/Counter Function

5 ) IF LN□=□ L□□□ (Judgment Command on Control Line)

<Entering>

Cursor Position	Enter & Operation
Command Field	4
Sub-Command Field	4
Operand Field	Select signals from 0:RTS, 1:CTS, 2:DSR, 3: DCD, 4:DRT, 5: RI, 6:TRG.
	Select status from 0: non-active, or 1: active.
	Enter a label number in three digit decimal figures with the key, [0] to [9].

<Operation>

- The program control branches to the designated label number if the logic of the control lines specified in the operand field meets with the setting.

6) IF REG□ □ REG□ L□□□ (Judgment Command on Register Value)

<Entering>

Cursor Position	Enter & Operation
Command Field	4
Sub-Command Field	5
Operand Field	Enter a register number with the key, [0] to [F].
	Input the inequality by 0 : = , 1 : ≠ , 2 : < , 3 : > , 4 : ≤ , 5 : ≥ .
	Enter the label number in three digits decimal figures with the key, [0] to [9].

<Operation>

- The program control branches to the designated label, if the inequality relation between registers of operand filed is satisfied.

 If you want to compare the contents of a register with a constant value, execute this command after setting the constant value in another register by using the SET command.

7) IF TBL□□ L□□□ (Judgment Command on Data Table Comparison)

<Entering>

Cursor Position	Enter & Operation
Command Field	4
Sub-Command Field	6
Operand Field	Operand Field: Specify the table group in the 1st digit, and the table No. in the 2nd digit with 00~9F.
	Enter the label number in three digits decimal figures with the key, [0] to [9].

<Operation>

- The program control branches to the designated label number if data satisfied up to 23 characters from the top of data, which is registered in the specified data table in the operand field, is detected in the frame buffer by the WAIT FRM command.
- Parity bit is not a object to be compared.

 4.1 Register Transmission Data

8) IF DA □□+REG□ L□□□ (Judgment Command on Data Array Comparison)

<Entering>

Cursor Position	Enter & Operation
Command Field	4
Sub-Command Field	7
Operand Field	Operand Field: Specify the data array No. with the key, 0 to 9.
	Enter a data array number with the key, [0] to [F]. [END/X]: * (Don't Care) allows the offset to be invalid.
	Enter the label number in three digits decimal figures with the key, [0] to [9].

<Operation>

- The program control branches to the designated label number if data, satisfied with data being set in the specified data array in the operand field, is detected in the frame buffer.
- The method of designating a data array number is the same as that of “SEND DA Command.”

## CALL Command (Subroutine Call Command)

The CALL command is used to call a subroutine.

CALL L□□□

<Entering>

Cursor Position	Enter & Operation
Command Field	5
Sub-Command Field	-
Operand Field	Enter the label number in three digits decimal figures with the key, [0] to [9].

<Operation>

- The program control branches to the subroutine that is marked with the label number specified in the operand field. The subroutine can be nested up to 100 folds.

## RET Command (Command to Return from Subroutine)

The RET command is used to return from the subroutine to the main routine.

RET

<Entering>

Cursor Position	Enter & Operation
Command Field	6
Sub-Command Field	-
Operand Field	-

<Operation>

- The program control returns from the subroutine to the main routine. This command must be set to the end of the subroutine.

## SET Command (Device Setting Command)

The SET command is used to control timers, counters, and registers and to preset values for them. Also, it is used to preset the logical values of the control lines, and to control the buzzer and external trigger output.

### 1) SET REG□ □□□□□ (Register Preset Command)

<Entering>

Cursor Position	Enter & Operation
Command Field	7
Sub-Command Field	0
Operand Field	Enter a register number with the key, [0] to [F].
	Enter a preset value of the register in six digits decimal figures with the key, [0] to [9]. Or, Specify either increment or decrement with the key A or B..

<Operation>

- The content of the register specified in the operand field is changed.

Register Preset Value	Setting Condition
Six Digits Decimal Figures	The preset value is entered in the register.
A	1 is added to the register contents "INC".
B	1 is subtracted from the register contents "DEC".





- When the program starts, all the registers will be set 000.

### 2) SET LN□=□ (Control Line Logic Setting Command)

<Entering>

Cursor Position	Enter & Operation
Command Field	7
Sub-Command Field	1
Operand Field	0 : RTS, 1 : CTS, 2:DSR, 3:DCD, 4:DTR, 5:RI, 6 : TRG
	Select status from 0: non-active, or 1: active.

<Operation>

- The control line specified in the operand field is set to the specified state.
  -  The control line is set to mark state ("0") when the program starts.
  -  The settable control line is subject to the condition of DTE/DCE of your analyzer.
  -  If the "auto line control" is "ON", the conditions of RTS/DTR/CTS/DCD are changed without being related to this command. Normally, set "OFF".
  -  RI operates in the V.35 mode only.

3 ) SET TM □ □ □ □ □ □ (Timer Control Command)

<Entering>

Cursor Position	Enter & Operation
Command Field	7
Sub-Command Field	2
Operand Field	Enter a timer number with the key, [0] or [1].
	Enter a preset value of the timer in six digits decimal figures with the key, 0 to 9. Or, specify start, stop, and restart with the key, A to C.

<Operation>

- The preset value, which is compared with measurement value, is set to the timer specified in the operand field. Moreover, the timer operation is controlled.

Preset Timer Value	Setting Condition
Six Digits Decimal Figures	Set a preset value.
A	Starts the timer (START).
B	Stops the timer (STOP).
C	Restarts the timer [clear to 0 and start] (RESTART).

- Set the unit of timer and the comparison value in the timer/counter setting from the top menu.

 6.2 Timer/Counter Function

4 ) SET CT □ □ □ □ □ □ (Counter Control Command)

<Entering>

Cursor Position	Enter & Operation
Command Field	7
Sub-Command Field	3
Operand Field	Enter a counter number with the key, 0 or 1.
	Enter a preset value of the counter in six digits decimal figures with the key, 0 to 9. Or, specify increment or reset with the key( A, B ) .

<Operation>

- The preset value, which is compared with measurement value, is set to the counter specified in the operand field. Moreover, the counter operation is controlled.

Register Counter Value	Setting Condition
Six Digits Decimal Figures	Sets the preset counter value.
A	Adds 1 to the counter (INC).
B	Clears the counter (RESET).

- Set the unit of timer and the comparison value in the timer/counter setting from the top menu.

 6.2 Timer/Counter Function

5 ) SET BZ (Buzzer Control Command)

<Entering>

Cursor Position	Enter & Operation
Command Field	7
Sub-Command Field	4
Operand Field	-

<Operation>

- Buzzer sounds.

6 ) SET OUT (Trigger Out Output Command)

<Entering>

Cursor Position	Enter & Operation
Command Field	7
Sub-Command Field	5
Operand Field	-

<Operation>

- The output pulse is delivered to the trigger out terminals (L level output for about 1mS).

 If this command is executed again during outputting the pulse, it extends L level for about 1ms.

## 7) SET DA□□ □□□□□□ (Data Array Setting Command)

<Entering>

Cursor Position	Enter & Operation
Command Field	7
Sub-Command Field	6
Operand Field	Operand Field: Specify 2 digits of data array number with the key, 0 to 9.
	Enter a string of up to eight characters in hexadecimal code. To enter a string of less than eight characters, finish the entry by pressing ▼ and proceed to the next line.

<Operation>

- The specified character strings are set to the data array of the designated number.

## 8) SET DV□□ REG□ □ (Data Array Setting Command)

<Entering>

Cursor Position	Enter & Operation
Command Field	7
Sub-Command Field	7
Operand Field	Operand Field: Specify 2 digits of data array number with the key, 0 to 9.
	Input the set-register number with the key, 0 to F.
	Enter the digit number of a character with the key, 0 to 6.

<Operation>

- Set the contents of specific register in the data array as data strings.

e.g.) Transmitting REG0 value 12 as a character string of five digits

- 1) Set 12 to REG0.
- 2) Change 12 into a character string of five digits. And set it to DA00.
- 3) Transmit DA00 (00012).

## INT Command (Trigger Interrupt Command)

The INT command monitors whether or not the conditions of trigger 0 are satisfied while the program is running. And when the conditions are satisfied, the program control branches to the designated label number.

### INT TRG0 L□□□

<Entering>

Cursor Position	Enter & Operation
Command Field	8
Sub-Command Field	-
Operand Field	Enter a label number in three digits decimal figures with the key, 0 to 9.

<Operation>

- On executing this command, the conditions of trigger 0 are monitored to check if they are satisfied while the program is running. When the conditions are satisfied, the command during operating is completed. Then, the program control branches to the designated label number specified in the operand field. However, if your analyzer has been in a wait state by the WAIT command, this state will be cancelled by the INT command. Moreover, the WAIT command branches as an inoperative command during operating.
- Trigger conditions are not monitored while the destination subroutine of the branches is being executed. Monitoring is resumed when the RETI command returns the program control from the subroutine to the main routine. The following two things are all ignored. One is the valid and invalid condition for the specified trigger. The other is the content being set for “Action”.
- Only trigger factors are used. Other information such as trigger valid/invalid and trigger action are not used.

### 6.1 Trigger Function

#### ◆ Set more than one INT commands

If more than one INT commands are set and they branch to different labels, only the latest INT command is operated. (The INT command has to be executed before satisfying the trigger condition.)

#### ◆ Set “line state” for trigger factor “0”

If “line state” is set for trigger factor “0” of INT command, it branches to the label when INT command is executed and line state is changed its status. (non-matched -> matched)

## RETI Command (Trigger Interrupt Reset Command)

---

The RETI command returns the program control to the main routine from a subroutine which the program control is branched to by the INT command.

RETI L□□□

<Entering>

Cursor Position	Enter & Operation
Command Field	9
Sub-Command Field	-
Operand Field	Operand field: input 3 digits of label number with the key, 0 to 9. Or input "don't care" (*) by [END/X].

<Operation>

- The program control returns to the main routine from a subroutine which the program control is branched to by the INT command. If the label number of three digits is entered in the operand field, the main routine is restarted at the instruction marked with the label number. If "Don't Care" is entered in the operand field, the main routine is restarted at the instruction next to that which is being executed before branching by the INT command.

### ◆ Return point during wait status

When the WAIT command is executed and it becomes the waiting status, next command after WAIT command is executed if the program is branched by the INT command after trigger condition 0 is satisfied and the returned point of REIT command is "don't care". More over, it is possible that frame buffer becomes empty when WAIT FRM command is branched to wait status and no command is executed.

## DISI Command (Trigger Interrupt Disable Command)

---

The DISI command disables branching when trigger conditions are satisfied after executing the INT command.

<Entering>

Cursor Position	Enter & Operation
Command Field	A
Sub-Command Field	-
Operand Field	-

<Operation>

- The branch of programs on satisfaction of trigger conditions is disabled.
- To enable branching, execute the INT command again.

## STOP Command (Program Quitting Command)

---

The STOP command stops a running program.

<Entering>

Cursor Position	Enter & Operation
Command Field	B
Sub-Command Field	-
Operand Field	-

<Operation>

- The program simulating operation is stopped. And then, the analyzer stops measuring.

## LBL Command (Command to Define Label)

---

The LBL command defines the destination of a branch command.

L□□□

<Entering>

Cursor Position	Enter & Operation
Command Field	C
Sub-Command Field	-
Operand Field	Enter a label number in three digits decimal figures with the key, 0 to 9.

<Operation>

- The LBL command defines a branch destination of the following commands: GOTO, IF, CALL, INT and RETI.
- The LBL command has no effect on the operation as the NOP command.

## ■ Sample Program

The program shown below transmits data in the data table 00. If the A<sub>K</sub> characters (06h) are received, it transmits OKC<sub>R</sub> and resend. If an error is received, it transmits data in the data table 01 and resend after 500ms waiting time. Or, if no response is received within 3 seconds, it transmits data in the data table 02 and resend. After that, the program will stop.

```

SET TM0 003000      ..... Sets three seconds to timeout.
INT TRG0 L004      ..... Executes the INT command (Monitoring timeout)
,
L001
SET TM0 RESTART    .... Restarts timer 0.
SEND TBL00        ..... Transmits data in the data table 00.
WAIT FRM CLR      ..... Waits for receiving a signal of one frame.
SET TM0 STOP      ..... Stops timer 0.
IF TRG1 L003      ..... Judges errors.
IF CHR AK L002    ..... Judges AK characters(06h).
GOTO L001         ..... Branches to retransmission process.
,
L002
SEND CHR O K CR  ..... Transmit "OK CR"
GOTO L001         ..... Branches to retransmission process.
,
L003
SEND TBL01        ..... Transmits data in the data table 01.
WAIT TM 0500     ..... Wait 50ms
GOTO L001         ..... Branches to retransmission process.
,
L004
SEND TBL02        ..... Transmits data in the data table 02.
RETI L005        ..... Branches to the end of the program.
,
L005
STOP

```

< Other setting >

Data table 00:123456789C<sub>R</sub>

Data table 01:NG C<sub>R</sub>

Data table 02:TIMEOUT C<sub>R</sub>

Factor of trigger "0": Timer/Counter

Timer/Counter setting: Timer 0, comparison value: 3000, resolution: 1ms

Factor of trigger "1": error

< Example of above program >

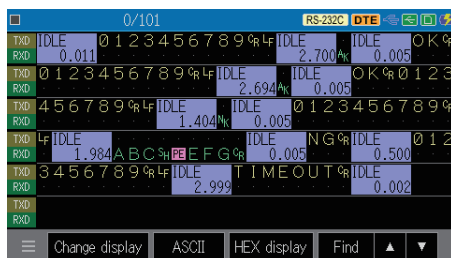

# Chapter 5 BERT Function

The analyzer has the function to send a test pattern and the function to compare the received data with the test pattern. By a loopback test or a face-to-face test, the quality of the data communication line including the modem etc. can be evaluated and the failure point of the data communication line can be isolated.

## 5.1 Connection and Settings

Select the measurement port according to the interface to be tested, and connect as follows according to the test method.

 2.3 Measurement Port

### Loopback test

The test pattern data sent from this unit is looped back and tested at each point on the communication line. You can evaluate the round-trip communication line that goes through each loopback point and can isolate the failure point by changing the loopback point

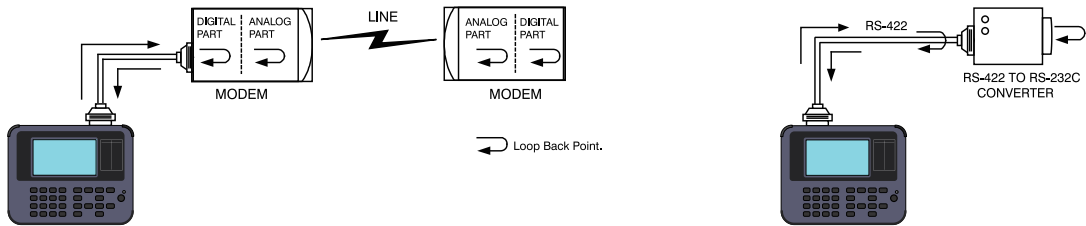

 Setting and switching of the loopback point in the device under test such as a model may be possible using the self-test function of the device under test. If you cannot loop back inside the device, loop back at the connector.

### End-to-End Test

The end-to-end test is a test in which a device with the BERT function as this unit has is connected to the other party and the same test pattern is sent and received each other. This test allows you to evaluate the transmit line and receive line separately.

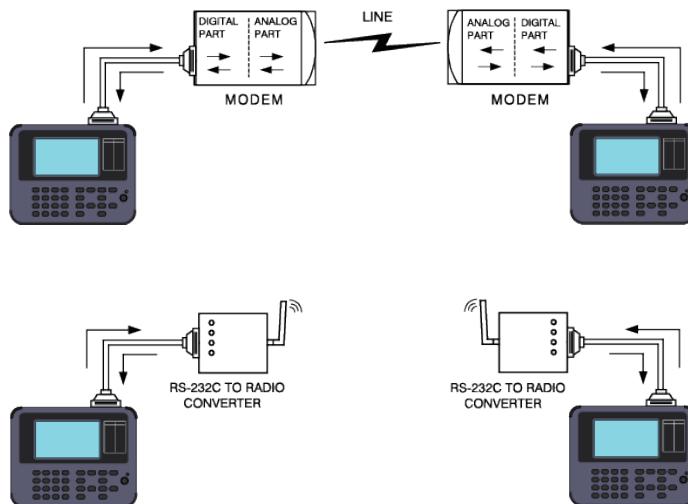

The BERT function works in either asynchronous or synchronous communication. First, set the protocol, communication speed, etc. in “Configuration” at the top menu.

○ When testing asynchronous communication

Set the protocol “ASYNC”. It tests at the speed set by “TXD speed” and “RXD speed”, and the test pattern is divided into the bit length specified by “Data bit”, and the start bit and the stop bit specified by “Stop bit” are added. Other settings such as “parity” are meaningless and invalid in the BERT function.

The added start bit and stop bit are not measured.

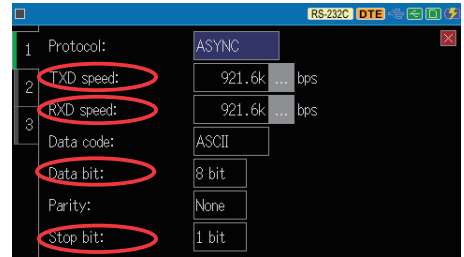

○ When testing synchronous communication

Set the protocol “SYNC / BSC”. It tests at the speed set by “TXD speed” and “RXD speed”, and the test pattern is sent and received by the synchronous clock specified by “Clock”. The character sync setting is used for convenience. No SYNC code is added to the test pattern, and the other setting items are meaningless and invalid with the BERT function.

Next, set the BERT test mode and test pattern.

Display the top menu screen with [MENU] and touch “Function”.

Select “BERT” at the operation mode selection screen and touch “Advanced settings” at the bottom of the screen to display the BERT setting screen.

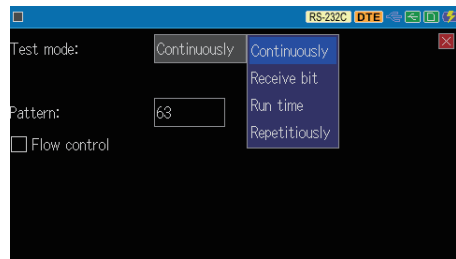
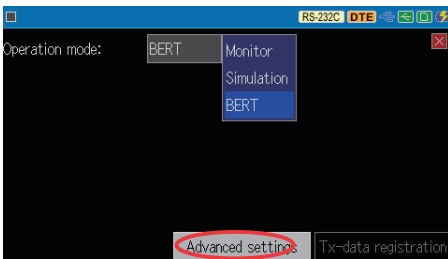
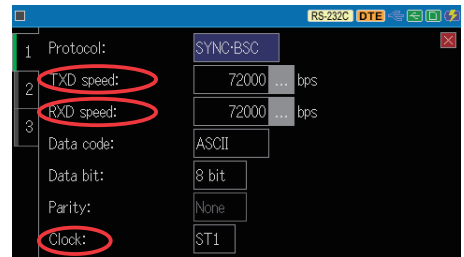

■ Test mode

Select the operation mode of BERT.

Continuously : It continues measurement until a stop operation for measurement.

Receive bit : It continues the test until the effective received bit number reaches the value specified at “bit count”.

Run time : After establishing synchronization at first, it continues the test for the specified seconds set at “Run time” (maximum: 9999999 seconds).

Repetitiously : It repeats measurement up to max.2000 times for each time set at “Time resolution” (1 to 1440 minutes).

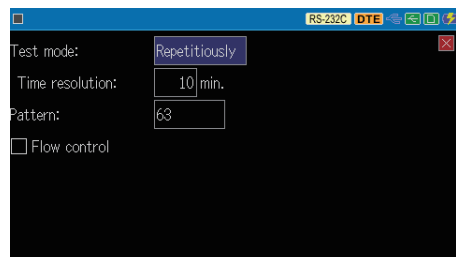
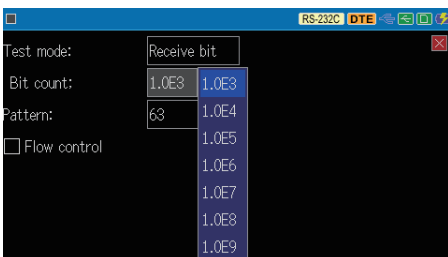

The receive bit is exponential. For example, 1.0E5 = 10,000.

■ Pattern

Select the test pattern data to be sent/received.

Name	Content
63	2 <sup>6</sup> -1 (Generator polynomial X <sup>6</sup> + X + 1) Random code
511	2 <sup>9</sup> -1(Generator polynomial X <sup>9</sup> + X <sup>4</sup> + 1) Random code
2047	2 <sup>11</sup> -1 (Generator polynomial X <sup>11</sup> +X <sup>2</sup> + 1)Random code
Mark	All 1
Space	All 0
ALT	10..
D B L - ALT	0011..
3 in 24	01000100000000000000100..
1 in 16	1000000000000000..
1 in 8	10000000..
1 in 4	1000..

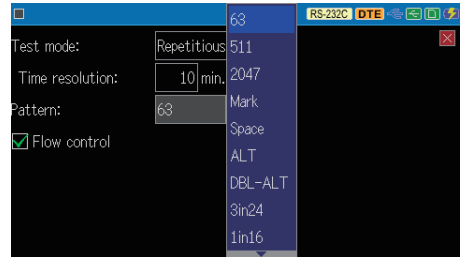

■ Flow control

If checked, RTS-CTS flow control is enabled. When this unit is DTE, the test pattern is sent only when CTS is active, and when this unit is DCE, the test pattern is sent only when RTS is active.

If unchecked, the test pattern will be sent regardless of the state of the RTS-CTS control lines.

## 5.2 Start and Stop

When you press [RUN], it starts to transmit the test pattern and compares the received data and the test pattern. Initially, until the initial pattern of the test pattern is received and synchronization is established, “Sync. search” message is displayed. After synchronization is established, “Measuring” message is displayed and error rate measurement starts.

When using the RS-232C port, simultaneously with the start of test pattern transmission, when it is set to DTE the RTS and DTR signals are activated, and when it is set to DCE the CTS, DSR, and DCD signals are activated. When using the TTL port, only RTS is active.

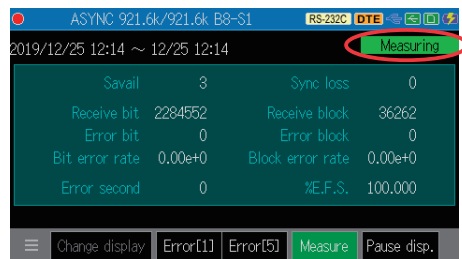
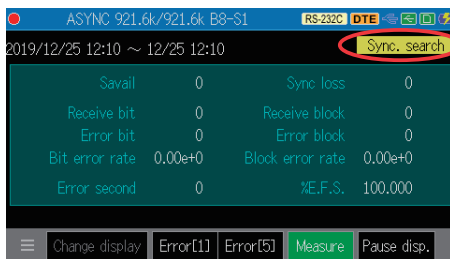

When the test mode is set to “Repetitiously”, the start time and measurement elapsed time of each measurement are displayed in “year/month/day/hour/minute”.

The following operations are available during measurement.

- “Error[1]” Inserts a 1-bit error in the test pattern. You can also insert it by [0].
- “Error[5]” Inserts a 5-bit error in the test pattern. You can also insert it by [1].
- “Pause disp.” Pauses the display update. Touch again to restart the displaying. You can also pause it by [ESC].
- “Measure” It finishes only the error rate measurement while it keeps transmitting the test pattern. Touch again to start a new measurement.

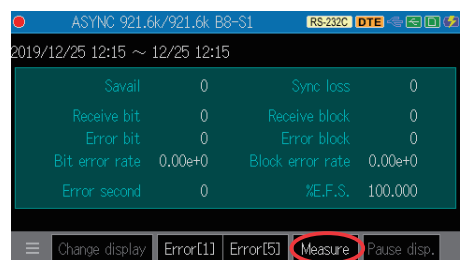

When you press [STOP], the test pattern transmission and error rate measurement will end. Depending on the test mode, the measurement will end automatically when the set conditions are met.

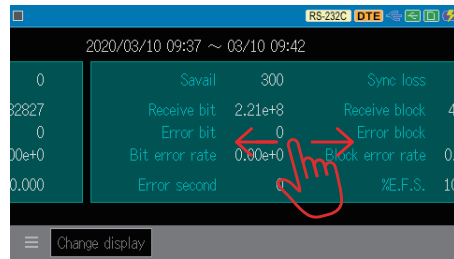
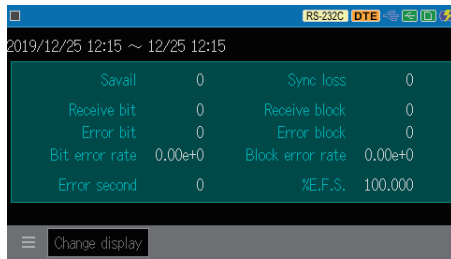

When the test mode is set to “Repetitiously” and several measurements are taken, you can swipe the screen left or right to switch and display the measurement data.

- ☰ You can switch and display the multiple measured data using [◀] and [▶].
- ☰ You can display the first measurement data by [TOP/DEL] and the last measurement data by [END/X].

## 5.3 Contents of the Line Quality Data

You can measure the communication error rate with parameters which comply with ITU-T Recommendation G.821.

Item	Contents	Range of measurement	Remark
Savail	Effective time since the first synchronization was established	0 ~ 9999999(sec)	1),2)
Receive bit	Number of received bits during synchronization establishment	0 ~ 9999999 ~ 9.99E9	1)
Error bit	Number of bit errors	0 ~ 9999999 ~ 9.99E9	
Bit error rate	Bit error rate	0.00E-0 ~ 9.99E-9	
Sync loss	Number of loss of synchronization	0 ~ 9999	3)
Receive block	Number of received blocks during synchronization establishment	0 ~ 9999999 ~ 9.99E9	4)
Error block	Number of blocks with bit errors	0 ~ 9999999 ~ 9.99E9	4)
Block error rate	Block error rate	0.00E-0 ~ 9.99E-9	4)
Error second	Time when bit error was detected during Savail	0 ~ 9999	
%E.F.S.	Errored second rate (%)	0.000 ~ 100.000(%)	5)

- 1) Synchronization : When it receives normal data continuously for 32 bits establishment
- 2) Effective time : It counts the time when the bit error rate per second is less than 0.1% as the effective time. If the bit error rate of 0.1% or more continues for 10 seconds, that 10 seconds is excluded from the valid time. After the exclusion, if the bit error rate is less than 0.1% for 10 seconds, the 10 seconds are added and it restarts the counting.
- 3) Sync loss : When more than 200 error bits occur in 512 consecutive bits.
- 4) 1 block length : Number of bits for 1 cycle of test pattern.
- 5) %E.F.S :  $\frac{(\text{Savail}) - (\text{Error second})}{(\text{Savail})}$

# Chapter 6 Useful Functions

## 6.1 Trigger Function

The trigger function is a function that triggers a special measurement process (action) triggered by a specific condition (factor) such as the occurrence of a communication error during measurement operation or reception of specified data. By controlling the timer/counter, it can measure the communication response time and count the number of occurrences of specific events. This is useful when analyzing the flow of communication under the specific interest.

- ☞ The trigger function can only be used in the online monitor function, statistical analysis function (with restrictions), and MANUAL mode of the simulation function.
- ☞ The trigger factor setting is also used in the PROGRAM mode of the simulation function.

[Factor]

Error	Communication error, break, multiprocessor bit on
Character	Communication data of up to 8 characters
Line state	Logic state of interface signal line and external trigger input
Timer/Counter	Timer/Counter value match
Idle time	Idle time exceeding the specified time

[Action]

Buzzer	Buzzer sound
Stop measurement	Stops the measurement/test (offset number until stop can be specified.)
Save data	Save data before and after the trigger to the storage device
Timer control	Start/stop/restart of the timer 0/1 for trigger
Counter control	Count up/clear of the counter 0/1 for trigger
Trigger control	Enables/disables/inverts the state of trigger condition
Transmit data	Transmits the specified character string (during manual simulation)
OT2 pulse output	Outputs an L pulse of about 1 msec. to external trigger terminal OT2

- ☞ When used in the statistical analysis function, operations other than timer control, counter control, and trigger control are not executed.

### External trigger input/output

You can use an abnormal signal from an external device as a trigger input, or can detect the occurrence of a special factor on the communication line by this analyzer and notify it to an external measuring instrument such as an oscilloscope.

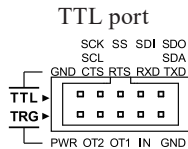

The TRG IN terminal can be specified as the line state condition of the trigger factor.

TRG OT1 terminal outputs L pulse for about 1 ms when all trigger factors are satisfied.

TRG OT2 terminal outputs L pulse for about 1 ms when OT2 operation is specified as a trigger factor.

- ☞ The trigger terminal is pulled up to 5V inside the analyzer.
- ☞ When a new trigger is generated while the trigger pulse is being output, it goes to HIGH level about 1 ms after the last trigger is generated.

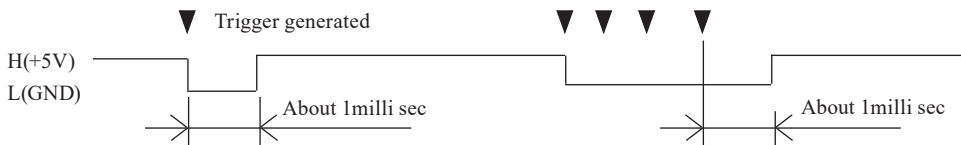

Press [MENU] and touch “Trigger” to display the trigger setting display.

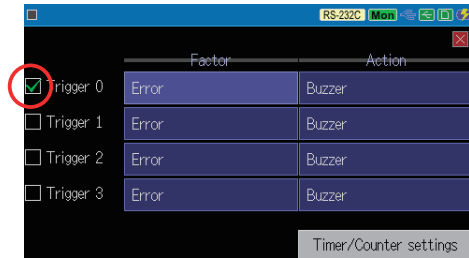
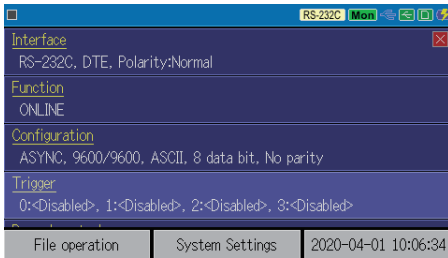

The  trigger number is valid. If you check more than one, it will be OR condition.

You can turn the check mark on/off by touching [] or by pressing [SHIFT] + [0] to [3].

Touch the factor or operation of the trigger number to move to each setting screen and change the setting. Touch the “Timer/Counter settings” at the bottom of the screen to set the comparative value of the timer or counter used in the trigger function.

6.2 Timer/Counter Function

- You can also move to the setting screen of the factor/operation to be changed by selecting with [▲], [▼], [◀], [▶] and press [ENTER].
- When the factor of each trigger number is satisfied, the corresponding operation is executed. When multiple triggers are enabled, the triggers with smaller trigger numbers are judged in order.

Trigger Factor

□ Error

A specific condition such as error or break are treated as a trigger condition.

- Errors which are not determined in the protocol of measurement target communication are not judged. BCC/FCS error is not judged if error check is not enabled in the basic communication condition settings.
- When “Parity error/MP bit = '1'” is valid, I2C acknowledge bit = '1' is also detected.

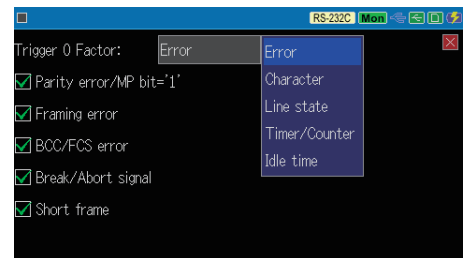

□ Character

The specified communication data will be the trigger condition.

■ Target line

Select either TXD side or RXD side.

■ Character

Set the data string to be detected up to 8 characters.

X (Don't Care) can be input by [END/X], and [ ] of bit mask W0 to 2 and SDLC/HDLC can be input by touching the corresponding mark at the lower right of the screen.

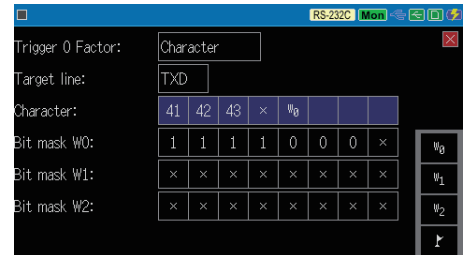

Bit masks W0 to 2 can be input by [SHIFT] + [0] to [2], and [ ] can be input by [SHIFT] + [F] too.

■ Bit mask

Set the bit string of bit mask W0 to 2 with [0], [1], and [END/X].

In the screen example, the trigger is activated when 5 bytes of 41h, 42h, 43h, arbitrary data, F0h or F1h are detected on the TXD side.

□ Line state

The condition of the control line and TRG (external trigger input TRG IN) are treated as the trigger condition. Specify the signal logic to detect with 1(H), 0(L), and X(don't care). The state judgment of 1 and 0 is as same as the line state display.

- ☰ With the AND condition of all signals, the condition is satisfied when the condition changes from mismatch to match.
- ☰ Control lines which are not on the selected measurement port are not judged.

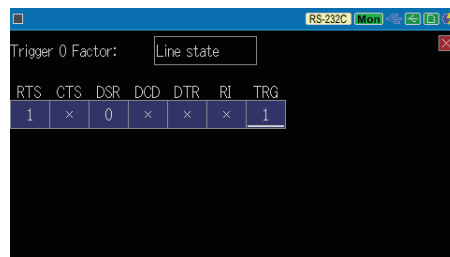

□ Timer/Counter

The value of the timer or counter is treated as the trigger condition. There are two timers and two counters that can be used as triggers. Specify which one you want to target at “Timer/Counter.” Also, input the value to be the condition at the Timer/Counter setting screen.

☰ 6.2 Timer/Counter Function

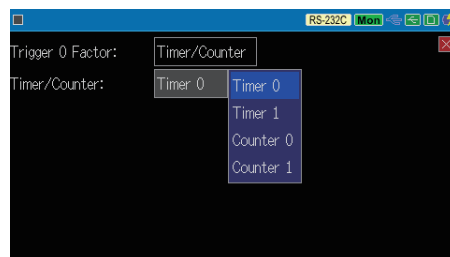

□ Idle time

The trigger condition is met when the idle time being measured exceeds the set value.

- ☰ Idle time can be set in the range of 0 to 9999. The time unit is as same as the idle time unit specified at the Record control.

☰ 2.6 Record Control ( Idle time)

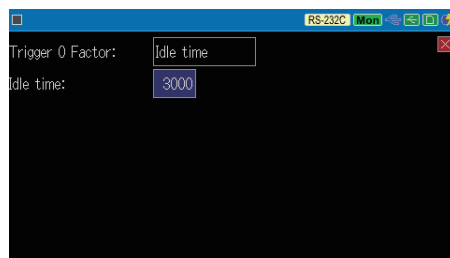

## ☰ Trigger Action

□ Buzzer

Touch the setting section and select “Buzzer”.  
The buzzer sounds for about 0.3 seconds when the corresponding trigger factors match.

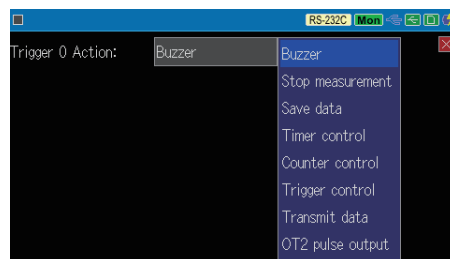

□ Stop measurement

The measurement stops after the trigger factor matches.

■ Stop

Set the conditions until the measurement stops after the trigger matches.

- Quick : Immediately stops measurement
- Before : Records more 64K data and then stops measurement
- Center : Records half the capture buffer and then stops measurement
- After : Stops the measurement keeping up to 64K data before trigger point

- ☰ “After” can record 100MB capture buffer size minus 64K data size after the trigger condition is met, so it can be used like a measurement start trigger.

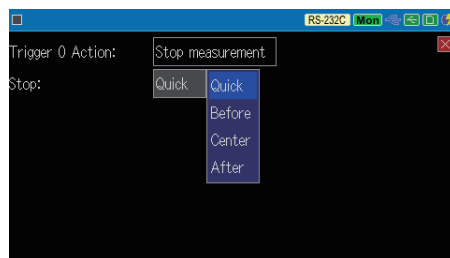

### □ Save data

The measurement data before and after the trigger factor match is automatically saved in the storage device as a trigger save file (TGSAVEnn.DT - nn is a serial number from 0 to 99 in the order of saving). The amount to be saved at one time can be specified by the number of data (maximum 9999) before (offset-) / after (offset+) with the trigger point as the center.

Insert a storage device (SD card or USB flash drive) into this unit, and specify it at "Save data" of the Auto save tab in "Record control" of [MENU].

- 📖 After the trigger factor is matched, the offset + minute data is saved in the file when it is captured. If you stop the measurement before capturing the data of that size, the file will not be saved.
- 📖 The next data save operation is ignored during the data save process.
- 📖 After TGSAVE99.DT, it will be overwritten by returning to TGSAVE00.DT. When the measurement is started again, it will be overwritten from TGSAVE00.DT.
- 📖 It does not write if the storage device is full.

After stopping the measurement, read the trigger save file into the capture memory and check it.

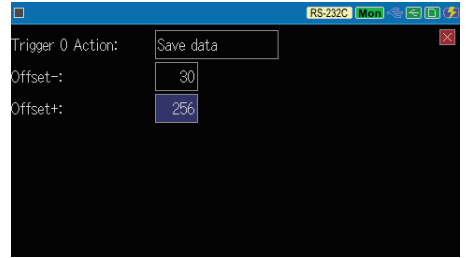

## 📖 8.2 File Management Function

### □ Timer control

Controls the timer.

Specify the timer to be controlled (timer 0, timer 1) and the control content (start, stop, restart from value 0).

## 📖 6.2 Timer/Counter Function

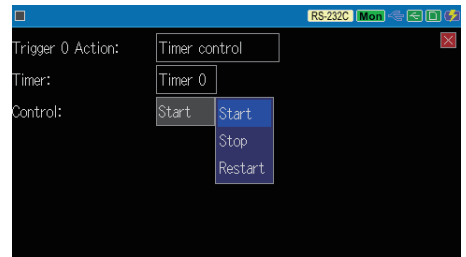

### □ Counter control

Controls the counter.

Specify the counter (counter 0, counter 1) to be controlled and the control content (increment: +1, clear: clear value to 0).

## 📖 6.2 Timer/Counter Function

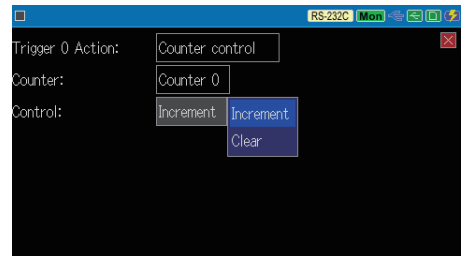

### □ Trigger control

Specify the trigger to be controlled (trigger 0 to 3), disable/enable, change the status of it (reverse enable and disable from the current status).

A trigger that is invalid (unchecked) at the start of measurement can be enabled by another trigger then it detects a specific condition during measurement. By doing so they can be used like a sequence trigger.

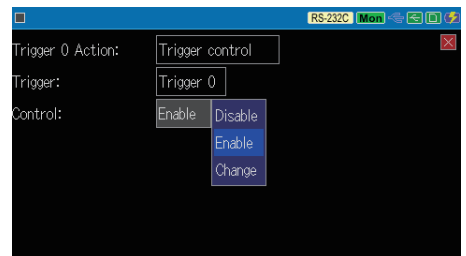

□ Transmit data

Specified data is sent after the trigger factor matches. Specify the group number (group 0 to 9) and table number (table 0 to F) of the send data table in which the data you want to send is registered. When you select “Fixed data” in the group specification, you can select the transmission data which is preset in this unit. For the “Response time” set the time (0 to 99999 msec.) until the data transmission starts after the trigger factor matches.

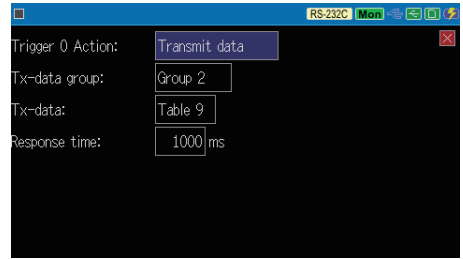

4.1 Register Transmission Data

This trigger action only works during simulation in MANUAL mode.

□ OT2 pulse output

A 1 milli sec Low pulse is output from TRG OT2 of the TTL port.

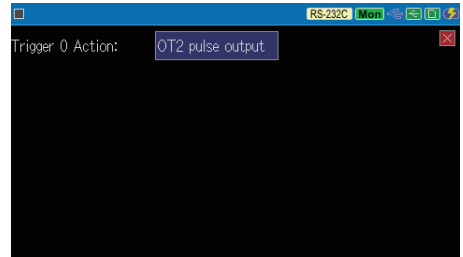

Trigger Setting Example

- ◆ When a communication error occurs, the buzzer sounds and the number of error occurrences is counted  
Enable trigger 0 and 1 and set Error as the factor and Buzzer and Counter control (increment) as the action.

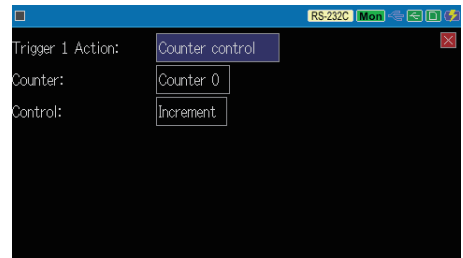
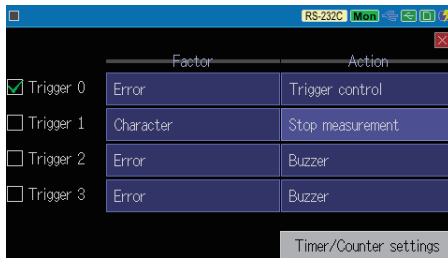

- ◆ Measurement stops when the receiving side detects character strings 31h, 32h, 33h after receiving the 41h, 42h, 43h.  
Enable only trigger 0. Set TXD data detection as the factor and Trigger control (enables trigger 1) as the action. For the trigger 1, which is enabled from trigger 0, set RXD data detection as the factor and measurement stop as the action.

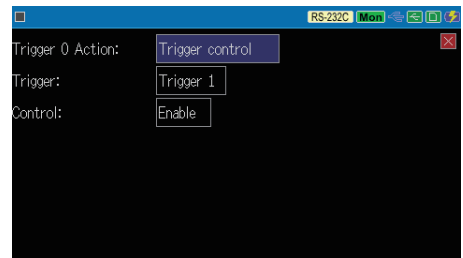
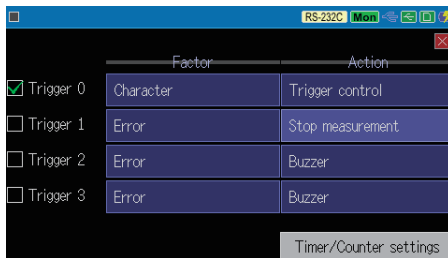

- ◆ Transmits the character string TEST (54h, 45h, 53h, 54h) when the external signal becomes L.  
Enable trigger 0, set Line state (set 0 to external trigger input) as a factor and data transmission as the action. Also, change the analyzer to the MANUAL mode (simulation) and register the character string TEST in the send data table.

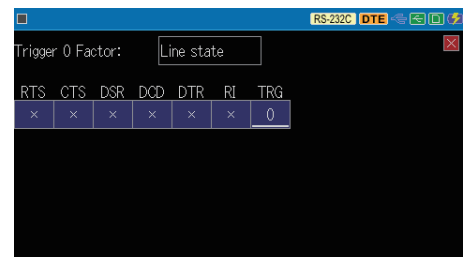
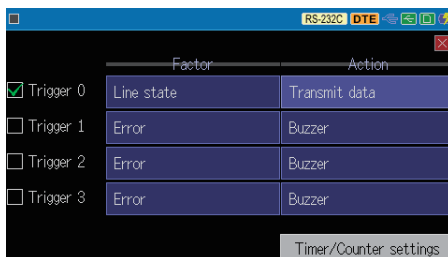

## 6.2 Timer/Counter Function

The timer / counter function is used together with the trigger function and program simulation function to measure the elapsed time from a specific condition and the number of occurrences of a specific factor.

Timers 0 and 1 are used to measure the time elapsed after a specific factor occurs.

Counters 0 and 1 are used to count the number of times a specific factor occurs.

Counters 2 and 3 are dedicated counters which count the number of transmitted and received data from the start to the end of measurement (maximum 4294967295).

### Setting

Display the top menu screen by [MENU] and select “Trigger”. Tap “Timer/Counter settings” at the bottom right of the trigger screen to display the setting screen.

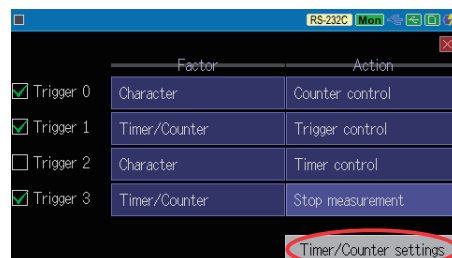
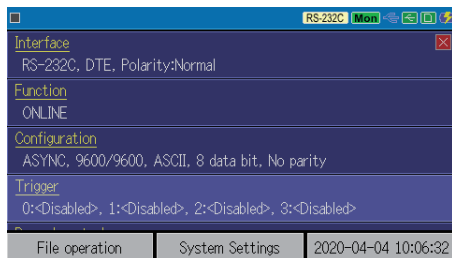

Set the comparison value (1 to 999999) of each timer / counter used for the trigger factor and the resolution (100msec, 10msec, 1msec) of each timer.

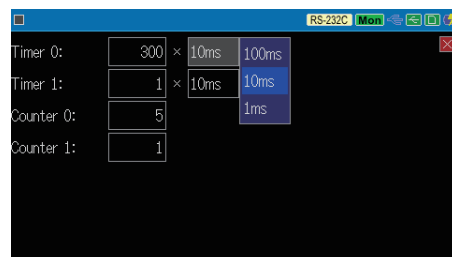

### Timer action

- 1) Cleared to 0 at the start of measurement. and the status changes to stop.
- 2) It starts, stops, or restarts (start after cleared to 0) according to the control information by the trigger function
- 3) When the set value (comparison value) of timer 0, 1 and the current value of timer 0, 1 match, the information is passed to the trigger function.
- 4) If the current value overflows, it continues counting from 0.
- 5) When you stop the measurement, the timer also stops at the point.

### Counter action

- General purpose counter 0,1.
  - 1) Cleared to 0 at the start of measurement.
  - 2) It is incremented (+1) or cleared by the control information from the trigger function.
  - 3) When the set value (comparison value) of counters 0 and 1 and the current value of counters 0 and 1 match, that information is passed to the trigger function.
  - 4) If the current value overflows, it continues counting from 0.
- TXD and RXD send/receive data number counter.
  - 1) Cleared to 0 at the start of measurement.
  - 2) It is incremented by 1 each time the data from the TXD on the transmitting side or RXD on the receiving side is received. (The maximum value is 4294967295)

## Display of timer / counter value

The status of the timer/counter value can be checked by tapping “Timer/Counter” from [☰] even during measurement.

- Tap “X” on the window to finish the display of timer / counter value.

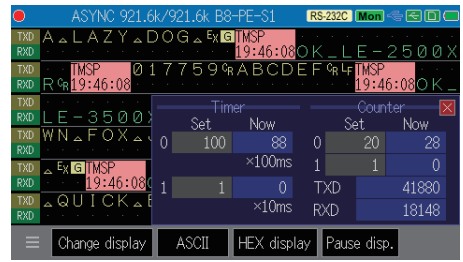

## 6.3 Timing Waveform Measurement Function

It is possible to measure the timing of change of the communication line with a time resolution of up to 20nsec and display it as a waveform like a logic analyzer do so.

### Setting

Display the top menu screen by [MENU] and tap “Wave monitor”. When using the timing waveform measurement function, check “Enable wave monitor” on the wave monitor setting screen and set the items.

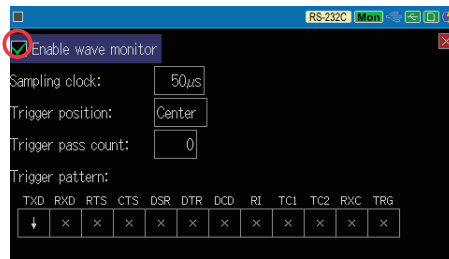
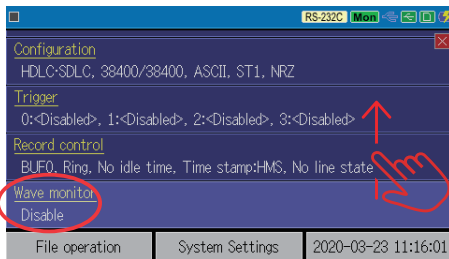

#### ■ Sampling clock

Tap the item and select the sampling clock cycle that is 5 to 10 times faster than the communication speed of the measurement target from 20nsec, 50nsec, 100nsec, 200nsec, 500nsec, 1µsec, 2µsec, 5µsec, 10µsec, 20µsec, 50µsec, 100µsec, 200µsec, 500µsec, and 1msec.

For example, when analyzing 38400bps timing, select about 2 µsec or 5 µsec.

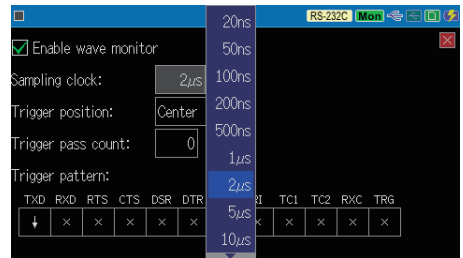

#### ■ Trigger position

Tap the item to select the trigger position of the waveform monitor. Set the trigger position in the waveform monitor sampling memory (for 2K sampling) depending on which part of the waveform measurement data -before or after the trigger- is prioritized.

**Before** : Captures some data from the trigger point and then stops.

**Center** : Stops at the point where before and after parts of the trigger have the same amount of data.

**After** : Captures a lot of data from the trigger point and stops.

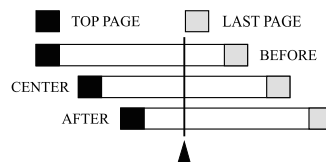
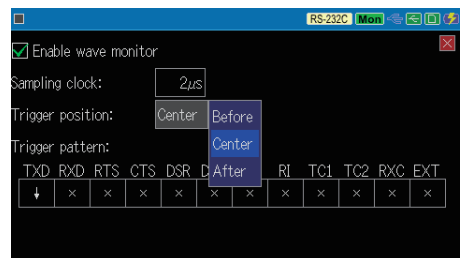

■ Trigger pass count

Set the number of times (0 to 9999) to ignore the trigger pattern match. When it is 0, the trigger will be established at the first trigger pattern match.

■ Trigger pattern

Sets the state of the signal line with which it automatically stops the waveform monitor measurement. The signals that can be set vary depending on the interface and the option board being used.

- [0] : 0
- [1] : 1
- [END/X] : X (Don't care)
- [SHIFT]+[0] : ↓ (Falling edge)
- [SHIFT]+[1] : ↑ (Rising edge)

- 📖 Be sure to set the edge (↑) (↓) to the trigger condition.
- 📖 TRG is the external trigger input TRG IN of the TTL port.

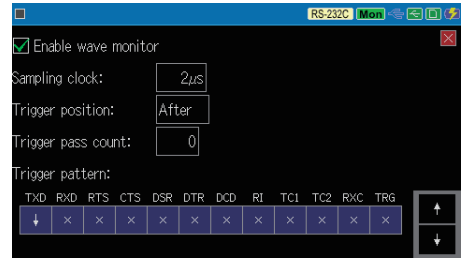

When RS-422/485 is selected



When TTL is selected



When using OP-SB5GL

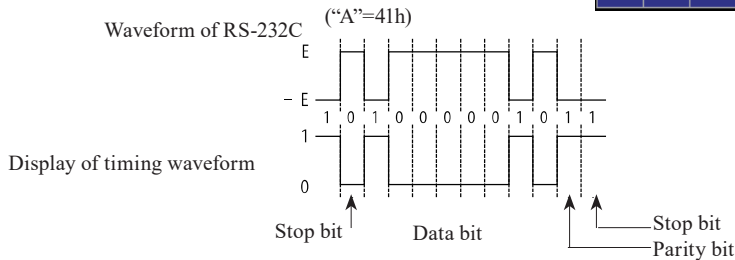

📖 Control

- 1) Press [RUN] to start timing waveform measurement at the same time as the normal measurement function starts. "📖" is displayed in the upper left of the screen.
- 2) When the waveform monitor trigger condition is met and the timing waveform sampling is completed, "📖" at the upper left of the screen disappears.
- 3) Press [STOP] to stop measurement.

📖 Display

Press the "Change display" at the bottom of the monitor data display screen for several times to switch to the timing waveform display screen.

■ Scroll the display

Swipe left or right to scroll to the part you want to see.

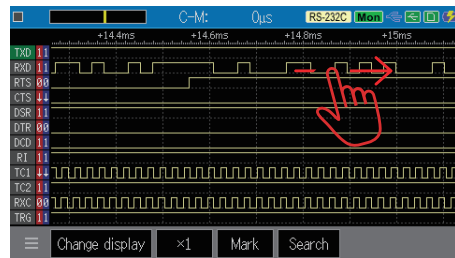
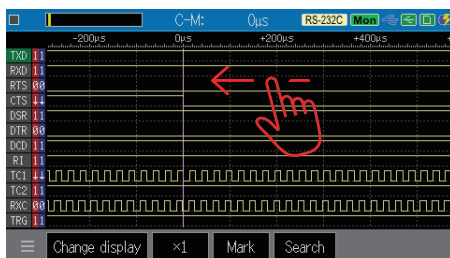

■ Zoom in/out of the display

Touch the magnification value to zoom in/out the display.

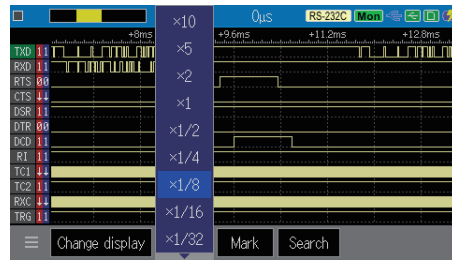
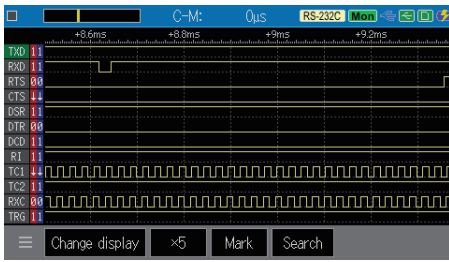

■ Time measurement between two points

On the screen, the blue dotted line is cursor C and the red dotted line is marker M.

First, move the cursor to the first signal position with [ ◀ ], [ ▶ ], and touch [ENTER] or “Mark” to move the marker to that position. Then, by [ ◀ ] and [ ▶ ] move the cursor to the signal position to where you want to measure the time from the marker position.

The time between the cursor and the marker is displayed at “C-M:” on the first line of the screen.

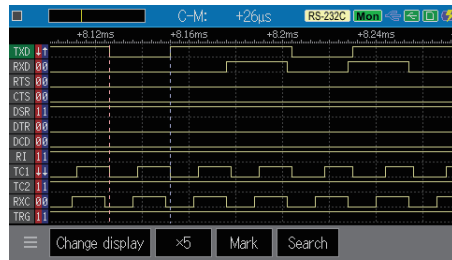
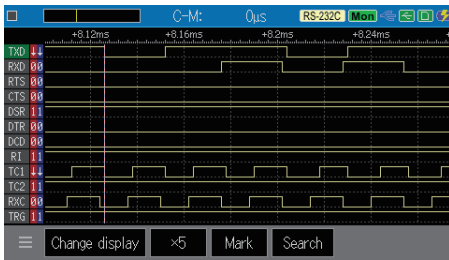

■ Search of signal status

When you touch “Search” at the bottom of the screen, the status display (1, 0, ↓, ↑) at the cursor position on the left of the screen becomes x, and the area turns to be the input area of the signal status for the search target. Input here the state you want to search, and use [ ◀ ] and [ ▶ ] to search in that direction and move the cursor to the matching one. Touch “Search” again to end the waveform search mode and [ ◀ ] and [ ▶ ] returns to cursor C movement.

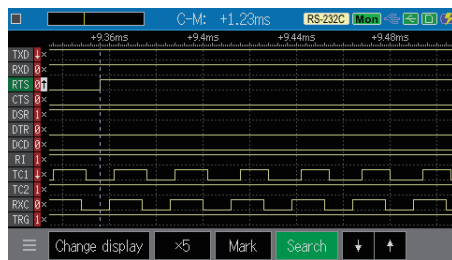
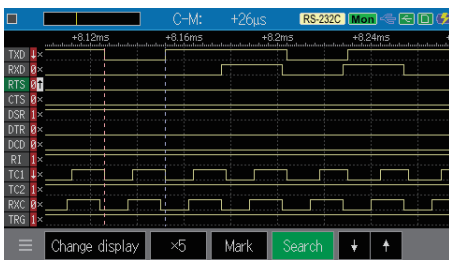

■ Change the display order of signal lines

Select the signal whose display order you want to change by [ ▲ ] and [ ▼ ]. Then you can use [SHIFT] + [ ▲ ] and [SHIFT] + [ ▼ ] to change the display order of the selected signals.

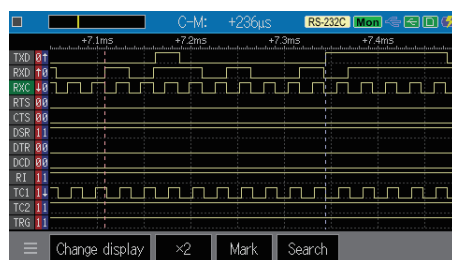
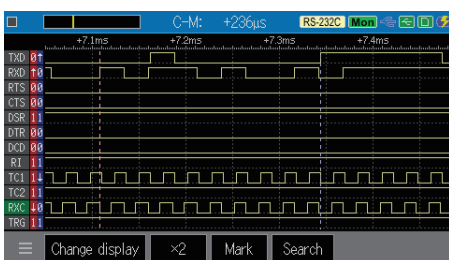

## 6.4 Auto Configuration Function

By using this function at online monitoring, you can automatically determine the communication conditions of the line to be monitored and start the measurement.

### How to use

By touching “Auto configuration” in the [☰] menu, “Analyzing transmission speed...” is displayed and the analysis process of communication condition starts.

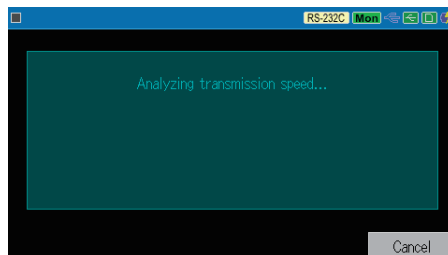
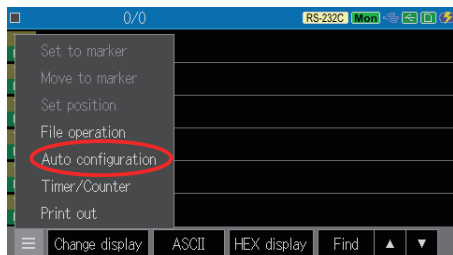

When the communication conditions are determined, the details will be displayed. A few seconds after that, the current communication condition settings are automatically changed to the determined communication conditions and it starts the measurement.

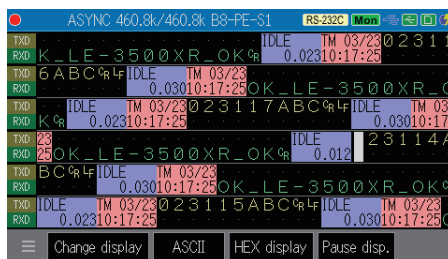
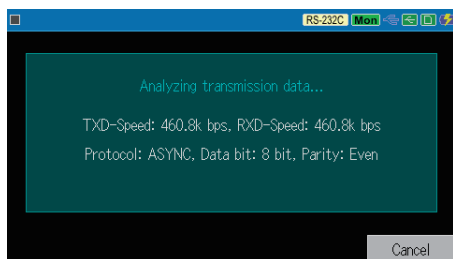

 If you touch “Cancel” or press [STOP] or [ESC] before it starts measurement, the analysis processing of communication conditions will be stopped and the current communication condition settings will not be changed.

The following conditions are required for the line to be measured in order to judge the communication conditions correctly.

- Communication speed is 460.8Kbps or less.
- Protocols are ASYNC, SYNC/BSC, or HDLC/SDLC.
- On the line communication data without error is flowing at a certain frequency.
- On the line communication data including bit patterns of '101' or '010' is flowing.



The auto configuration function of this analyzer is an auxiliary function for estimating the communication conditions.  
Please note that not all the conditions can be judged accurately.

## 6.5 Auto Save Function

By using the auto save function, the contents of the capture memory (captured data) can be automatically saved for a long time as a measurement log file (auto save file) of a specified size in a storage device such as an SD card. As you can check the auto-save file which was automatically saved while a rare communication failure occurred with the file management function and the attached PC link software, it is useful to analyze the communication failure of unknown cause.



### Preparation and settings

Set the SD card or USB flash drive of the appropriate capacity to the unit according to the time you want to record continuously.

< Estimated recording time by the storage device capacity >

Communication speed (*1)	Main unit memory only	8GB storage media	32GB storage media
9600bps	About 6 hours	About 20 days	About 80 days
115.2kbps	About 28 minutes	About 37 days	About 6.5days
1Mbps	About 200 seconds	About 5 days	About 20 days

\*1: For a communication line in which 1 Kbyte of data is transmitted in full duplex at 1 msec. intervals.

-  Only the SD cards sold by LINEEYE (LINEEYE option) are supported.
-  It uses a capacity of 4 bytes for each capture of transmitted/received data.

Display the top menu screen by [MENU], touch “Record control”, and then touch the “Auto save” tab to display the setting screen.

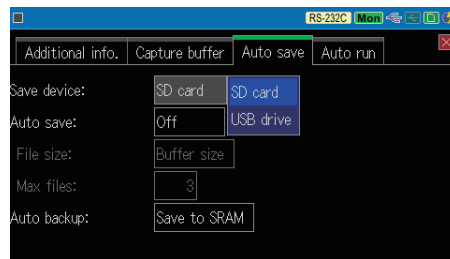
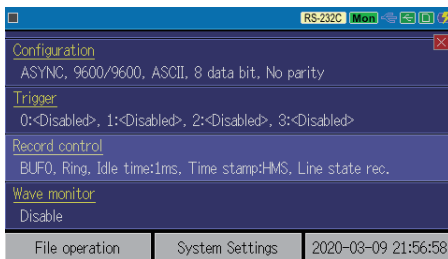

#### ■ Save device

Select the storage device to save the auto save file. Specify the SD card or USB flash drive inserted in the analyzer.

#### ■ Auto save

Set the condition of the auto save function.

- Off : Auto save function does not work
- Restart : Continuous ring recording of auto-save files within the maximum number of files
- Max-stop : Saves up to the specified number of auto save files and stops measurement
- Append : Continuous ring recording from the file number next to the existing auto save file number

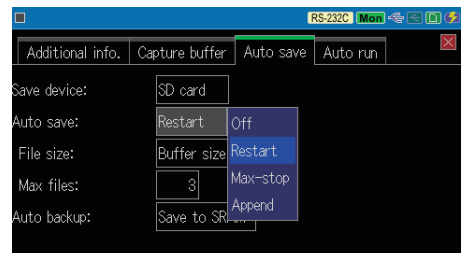

-  The name of the auto-save file which is automatically saved is #XXXXXXX.DT (XXXXXXX is a sequential number that increases by 1 from 0000000)



- If you set “Restart” or “Max-Stop”, all existing auto save files will be deleted at the start of measurement.
- When saving the measurement log for a long time with the auto save function, set the main unit capture memory to the ring buffer. Also, make sure that the trigger condition that stops the measurement is not set.



2.6 Record Control ( Buffer Full Stop)



6.1 Trigger Function

### ■ File size

Specify the file size of the auto save file from 1 Mbytes to 32 Gbytes or “Buffer size”. The “Buffer size” will be the same as the capture memory size.

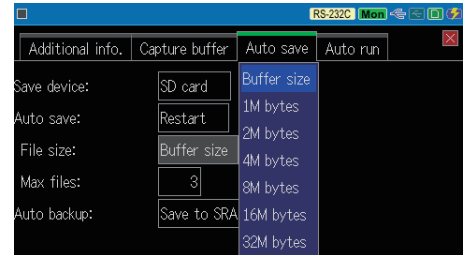

### ■ Max files

Set the maximum number of auto save files to be automatically saved.

- ☰ You can set 1 to 1024. However, the file size x maximum number of files is limited to 32 GB. Normally, set 3 or more.
- ☰ Even if the storage device has free space, it may not be able to store the specified maximum number of files due to media limitations.



## Start measurement

When starting measurement by [RUN], if there is an auto save file in the storage device, an overwrite confirmation message will be displayed. If you touch [RUN] or “Continue” again, the measurement will start. If you need to save the existing auto save file, stop it by [STOP] and save it to the HDD on your computer.

After the measurement starts, the auto save file will be continu-

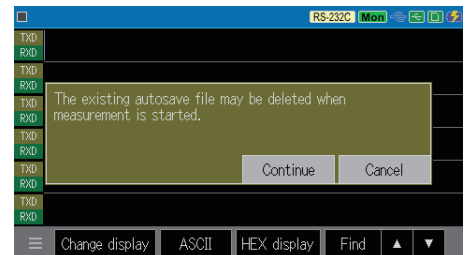

ously saved in the storage device each time a predetermined amount of data is recorded in the capture memory.

When the condition is “Restart” or “Append” and executing the recording, if the number of auto-save files exceeds the maximum number of files or if there is insufficient free space on the storage device, The new file is saved after deleting the old files (with auto-save file name of lowest number).

- ☰ The communication speed of the measurement target line from which automatically it saves communication data without loss is up to about 1 Mbps.
- ☰ Waveform monitor measurement data is not recorded in the auto save file.

## Check files by Wi-Fi connection

The PC software “LE File Downloader” is available to download files from the storage device of the analyzer to a PC via Wi-Fi connection. Without stopping the measurement, you can download the auto save file of the time of failure to your PC and analyze it in detail by the PC link software.

### 9.3 Take the data file while measurement

 In advance enable the Wi-Fi of the analyzer so that it can be connected to a computer.

## End of measurement

The measurement finishes by [STOP]. When the condition is “Max-stop”, the measurement will end automatically when the number of auto save files reaches the maximum number or when the storage device runs out of free space.

 When you press [STOP] to finish the measurement, “Under cleanup” is displayed until the measurement data saving is completed.

	<ul style="list-style-type: none"><li>• When using the auto save function, be sure to use it by bus power supply and take sufficient care not to cause a power failure which exceeds the battery operating time. If the battery is insufficiently charged and the power of the analyzer is turned off during auto save, it may damage the file and storage device.</li><li>• As not only files but the entire storage device may become inaccessible, never remove the storage device during auto save including when “Under cleanup” message is displayed.</li></ul>
---	---

## 6.6 Auto Backup Function

As the capture memory is DDR3-SDR AM the data in the memory disappears when the power is turned off. Therefore by this function, when the measurement is completed, the latest portion of the measured data, approximately 512 Kbytes, is automatically backed up to the battery-backed SRAM. Change the setting of this automatic backup function when you want to save all the measured data automatically or to delete the data when the power is turned off.

Press [MENU] and touch “Record control” and “Auto save” in order.

### Auto backup

Specify the destination to save the automatic backup data. The initial value is “Save to SRAM”.

**Off** : It does not execute automatic backup. Select this when you do not want to keep the measurement data after turning off the power.

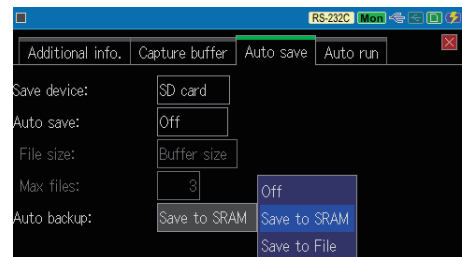

**Save to SRAM** : Saves the latest 512K bytes of measurement data to the built-in SRAM.

**Save to File** : Save the entire measurement data to the storage device specified at “Save device”.

 When “save to SRAM” is set, the measurement data saved in SRAM is automatically loaded to the capture memory when the power is turned on.

 When “Save to file” is set, all measurement data will be saved to a file named @AUTOBU $n$ .DT ( $n$  is the number of the used capture memory BUF0, BUF1 and BUF2). Load it manually to use it.

### 8.2 File Management Function

## 6.7 Auto Run Function

By using this function, you can repeat the measurement automatically for the specified period by specifying the date and time when the measurement starts and ends. It can start the measurement in conjunction with power-on and automatically finish the measurement at the specified date and time.

### Setting

Display the top menu screen by [MENU], touch “Record control”, and then touch the “Auto run” tab to display the setting screen.

#### ■ Mode

Select the measurement repetition period from Monthly (run monthly), Daily (run daily), or Hourly (run hourly).

#### ■ Run time

Set the date and time when to start the measurement according to the mode. It becomes effective when checked.

#### ■ Stop time

Set the date and time when to finish the measurement according to the mode. It becomes effective when checked.

 You can use it by checking one or both of “Run time” or “Stop time”.

#### ■ External power on Run

When checked, measurement starts 10 seconds after the start of USB bus power supply. It is used when you want to start measurement in conjunction with the turning on by the external power.

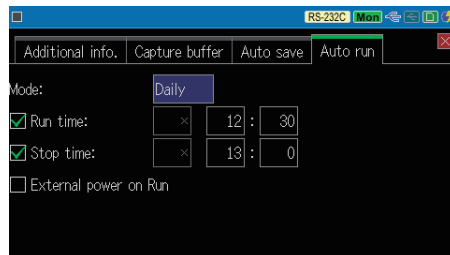

### Control

When “Run time” is checked, after pressing [RUN] it turns to be wait status until the specified time arrives. To cancel the waiting status press [STOP] or touch “Cancel”.

When the specified time comes, the measurement starts automatically. When the “Stop time” is checked, the measurement is performed up to the specified time and the measurement automatically stops. This measurement process will be executed repeatedly according to the condition set at “Mode”.

When “External power on Run” is checked, when USB bus power supply is started while the power of this unit is turned off, the power is automatically turned on, and 10 seconds after that, the measurement starts automatically without pressing [RUN].

 This function does not work when USB bus power is continuously supplied.

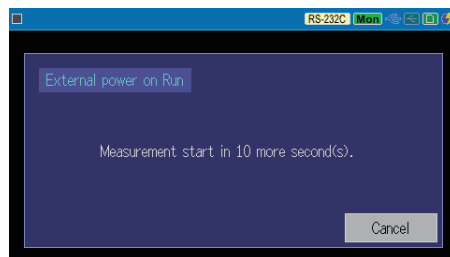
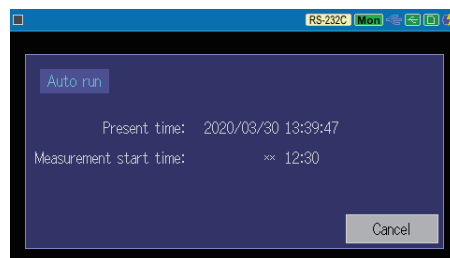

# Chapter 7 How to use as an analog measuring instrument

## 7.1 Preparation for analog measurements

### ■ Analog Pod Connection

Turn off the analyzer and connect an analog pod (sold separately) to the TTL port.

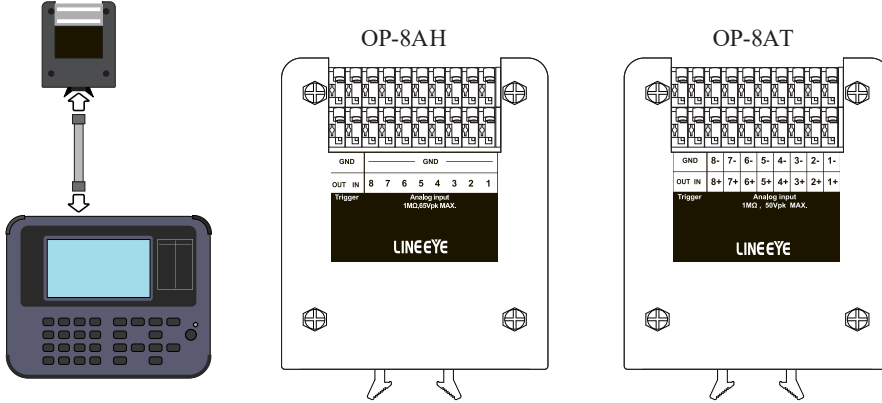

### ■ Connect to the Target Devices

Connect the analog signal to be measured to the terminal block of the analog pod.

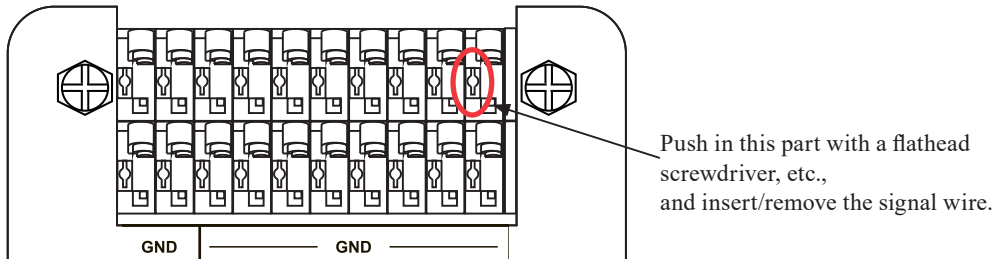

Please use an analog pod that corresponds to the analog signal.

	OP-8AH	OP-8AT
Measurement target	Voltage	Voltage, current, temperature
Input range	$\pm 60\text{V}, \pm 30\text{V}, \pm 16\text{V}, \pm 8\text{V}, \pm 4\text{V}$	$\pm 30\text{V}, \pm 10\text{V}, \pm 1\text{V}, \pm 100\text{mV},$ $0\text{-}20\text{mA}, \text{Temperature (Thermocouple)}$
Measuring cycle	$62.5 \mu\text{sec}$ to 4 msec	10 msec to 1 min
Measurement accuracy	60V range : $\pm(0.1\%rdg+3\text{mV})$ , 4V range : $\pm(0.1\%rdg+2\text{mV})$	30V range : $\pm(0.05\%rdg+3\text{mV})$ , 0-20mA range : $\pm 0.05\%FS$
Dielectric strength	Non-isolated, common between input channels and analyzer GND	Between input and analyzer: 1500Vdc, Between input channels: 350Vdc

Terminal block signal (OP-8AH)

Signal	Input channel
1	Ch1
GND	GND
2	Ch2
GND	GND
3	Ch3
GND	GND
4	Ch4
GND	GND
5	Ch5
GND	GND
6	Ch6
GND	GND
7	Ch7
GND	GND
8	Ch8
GND	GND
IN	External trigger input
GND	GND
OUT	External trigger output
GND	GND

Terminal block signal (OP-8AT)

Signal	Input channel
1+	Ch1 + input
1-	Ch1 - input
2+	Ch2 + input
2-	Ch2 - input
3+	Ch3 + input
3-	Ch3 - input
4+	Ch4 + input
4-	Ch4 - input
5+	Ch5 + input
5-	Ch5 - input
6+	Ch6 + input
6-	Ch6 - input
7+	Ch7 + input
7-	Ch7 - input
8+	Ch8 + input
8-	Ch8 - input
IN	External trigger input
GND	GND
OUT	External trigger output
GND	GND

Cannot input/output the external trigger in this model.

The GND terminal is a common ground. It is connected to the ground in the analyzer body electrically.

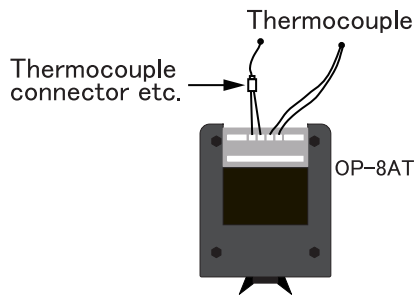
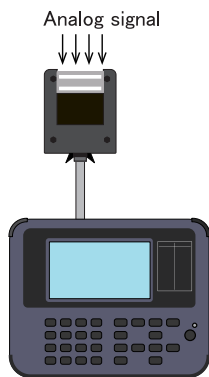

OP-8AH connection example

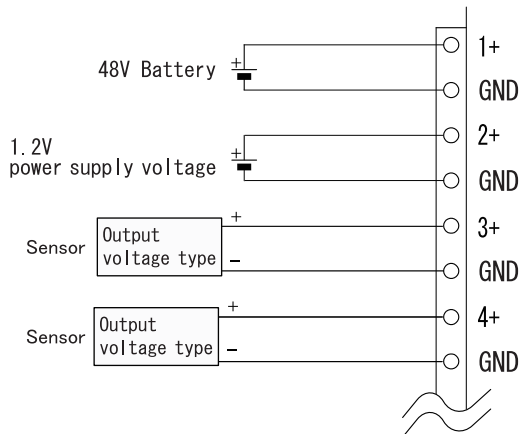

OP-8AT connection example

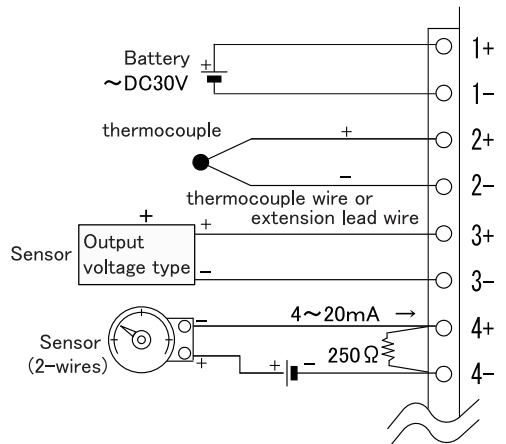

Input channels Ch5 to Ch8 can be connected in the same way.

## 7.2 Analog Measurement Mode

Press [SHIFT] + [1] while pressing the power button to start the firmware of analog measurement mode. On the next time, Analog measurement mode will start automatically when pressing the power button.)

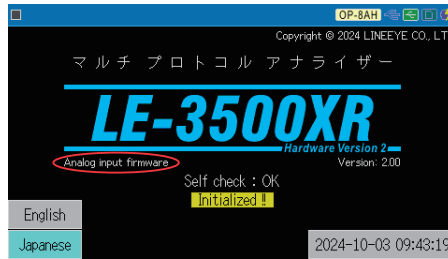

\* Press [SHIFT] + [0] while pressing the power button to start the analyzer mode.

- Before changing the firmware, save the necessary settings because all settings will be initialized (“Configuration” setting etc.).
- Only when the standard sub-board of LE-3500XR(V2)/LE-2500XR(V2) is inserted, the analog measurement mode will start. Other sub-boards (options) do not have this mode.

## 7.3 Analog Measurement Mode

Press [MENU] then touch “Interface/Configuration”

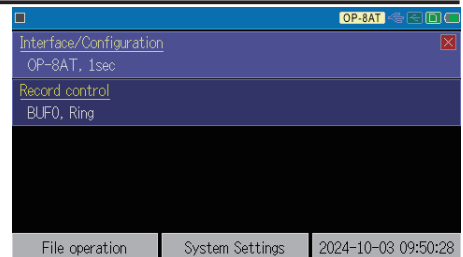

Touch “Pod” on the analog setting, and select “OP-8AH” or “OP-8AT”.

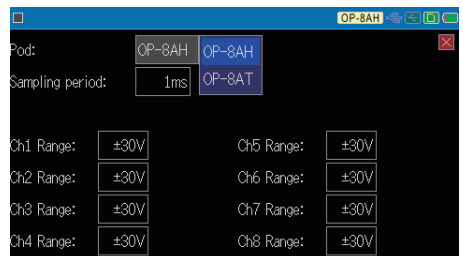

### ■ Setting of “OP-8AH” analog pod.

#### ◆ Sampling period

Select the sampling period. There are 7 selections from 62.5us (16Ksps) to 4ms.

#### ◆ Ch1~Ch8 Range

Touch “Chx Range” and select the analog inputting range. Select from  $\pm 4V \pm 8V$ ,  $\pm 16V$ ,  $\pm 30V$ ,  $\pm 60V$ .

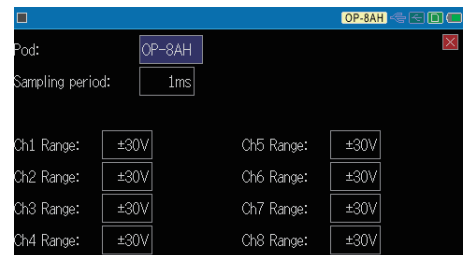

■ Setting of “OP-8AT” analog pod.

◆ Sampling period

Select the sampling period. There are 12 selections from 10ms to 1minute.

◆ Enable channel

Select the inputting channel. Selectable “Enable channel” varies according to the selected “sampling period”.

☰ When “sampling period” is 10ms, only Ch1 is selectable. When “sampling period” is 20ms, Ch1/Ch2/Ch3 are selectable.

◆ Power Frequency

Select an appropriate power frequency to minimize the effects of power noise.

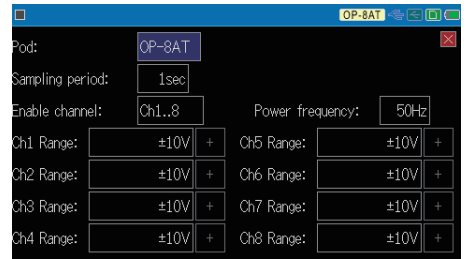

Appropriate sampling time will be set automatically according to the “Sampling period”, “Enabled channels” and “Power Frequency”.  
When measuring 8 channels, the most accurate sampling period is 1s (or longer).

◆ Ch1 ~ Ch8 x Range

Touch “Chx Range” and select the input range for analog input.

±100mV, ±1V, ±10V, ±30V

: It measures the voltage within the selected range.

0-20mA(250Ω), 0-20mA(50Ω)

: It measures amperometry using the amperometry resistance.

Temperature

: It measures the temperature using the thermocouples.

☰ The amperometry resistance and thermocouple are the options.

◆ TC type, Burnout detection, CJ compensation

If selecting “Temperature” for “Chx Range”, touch “+” and set thermocouple setting.

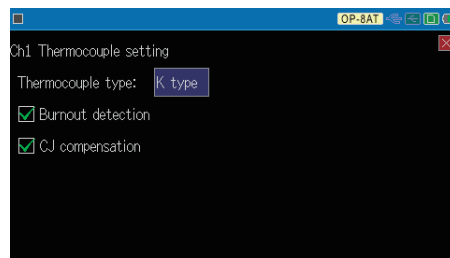

TC type : Select the thermocouples type from K,J,T,E,N,R,S,B.

Burnout detection : Mark on the box to detect the burnout. Disable this function if the thermocouples are very long and the voltage for detecting burnout may cause the malfunction.

Cold junction compensation : Mark on the box for normal use. Disable this function if using the external compensation device or ice both.

## 7.4 Start of analog measurement

The analog measured value are displayed and recorded in the inner memory after pressing [RUN]. Press “Change display” to display them in a graph. Press [STOP] to end the measurement.

☰ “Auto Save (save data in the storage device automatically)” and “Auto Run (start measuring at the specified time)” functions are available.

 6.5 Auto Save Function  
 6.7 Auto Run Function

### ■ OP-8AT

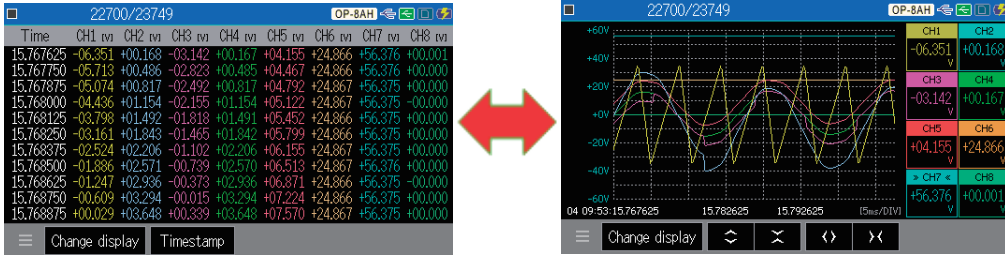

### ■ OP-8AH

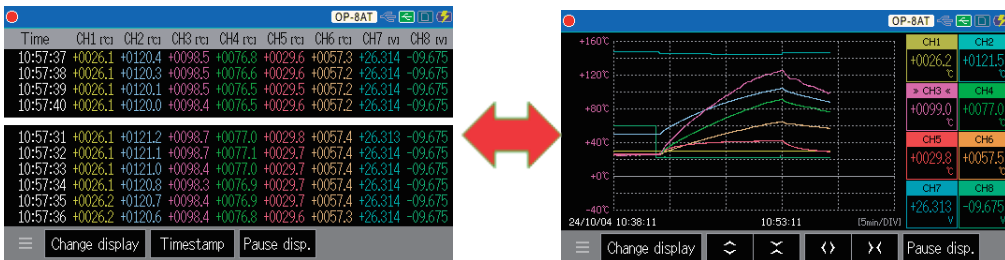

The graph indicates an elapsed time (horizontal axis) and change of measured data for each channel. On the right side of the screen (table), channel numbers and measured data are displayed. The value in the table is the latest result while measuring.





☰ After the test, the value in the table is one of the time on the left edge of the graph.

The vertical axis of the graph indicates the scale of the target channel with the mark “>> <<”. To change the target channel, tap the channel displayed on the right side of screen or press the number key ([1] to [8]). Tap the same channel again or press the same number key to hide/display the data in the graph.

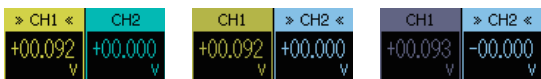
CH1 selection      CH2 selection      CH1 non-display



Tap“   ”or press [SHIFT] + [◀] [▶] key to change the scale of horizontal axis (time base).

Tap“   ” or press [▲] [▼] key to change the scale of vertical axis (time base).

Press [SHIFT] + [▲] [▼] key to change the starting point of vertical axis.

While measurement is stopped, swipe left or right or use the [▲] and [▼] keys to scroll through the data.

You can also move the graph display position up or down by swiping up or down or using the [▲] and [▼] keys.

### ■ Recordable data volume and recording time

It consumes 32 bytes in the recording area to capture one measured data, regardless of channel numbers.

Saving location	Number of measuring times	Measuring time (when measuring 1ms cycle)
Inner memory	Approx. 3.125 million times	Approx. 50 minutes
16Gbyte USB memory	Approx. 500 million	Approx. 133 hours

## 7.5 CSV conversion for Analog data

Touch[☰]-> “Export CSV” on the measured data display to save analog data in CSV format.

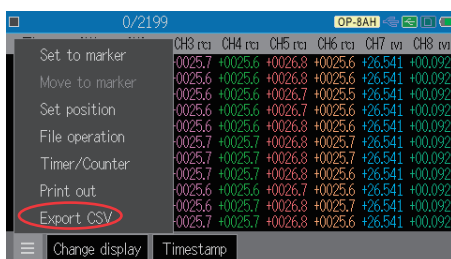

Select a saving location (“Destination”) and number of page (“page count”).

66 lines from currently displayed data will be saved in one page. To save all data, specify the max. number, “99999”.

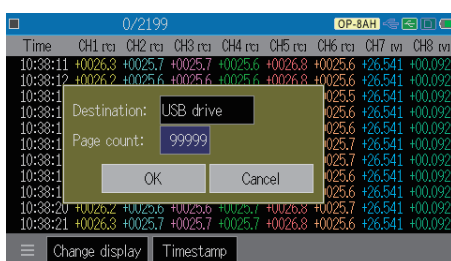

Touch “OK” to save data in the saving location in CSV format.

Example of CSV data in EXCEL.

	A	B	C	D	E	F	G	H	I	J	K	L
1	Model	LE-3500XR(V2)										
2	Version	2										
3	Extension	Standard										
4	Serial No.	xxxxxxx										
5	Start time	2024/10/4 10:38										
6	Stop time	2024/10/4 11:14										
7	ANALOG POD	OP-8AT										
8	SAMPL PERIOD	1sec										
9	CH1 RANGE	Temperature (Ktype)										
10	CH2 RANGE	Temperature (Ktype)										
11	CH3 RANGE	Temperature (Ktype)										
12	CH4 RANGE	Temperature (Ktype)										
13	CH5 RANGE	Temperature (Ktype)										
14	CH6 RANGE	Temperature (Ktype)										
15	CH7 RANGE	-30 - +30V										
16	CH8 RANGE	-30 - +30V										
17	Elapsed(sec.)	Date(YYYY/MM/DD)	Time(HH:mm:ss)	Time(ms)	CH1(dC)	CH2(dC)	CH3(dC)	CH4(dC)	CH5(dC)	CH6(dC)	CH7(V)	CH8(V)
18	0.837	2024/10/4	10:38:11	837	26.26	25.65	25.67	25.64	26.75	25.56	26.5406	0.092
19	1.838	2024/10/4	10:38:12	838	26.17	25.58	25.63	25.64	26.79	25.58	26.5407	0.0921
20	2.837	2024/10/4	10:38:13	837	26.14	25.57	25.58	25.58	26.7	25.55	26.5406	0.0921
21	3.839	2024/10/4	10:38:14	839	26.17	25.58	25.57	25.6	26.74	25.6	26.5406	0.0922
22	4.837	2024/10/4	10:38:15	837	26.19	25.63	25.61	25.63	26.75	25.63	26.5406	0.0921
23	5.837	2024/10/4	10:38:16	837	26.25	25.67	25.7	25.73	26.85	25.67	26.5406	0.0922
24	6.838	2024/10/4	10:38:17	838	26.26	25.68	25.67	25.67	26.77	25.65	26.5406	0.0921
25	7.837	2024/10/4	10:38:18	837	26.24	25.65	25.67	25.72	26.8	25.63	26.5406	0.0922
26	8.839	2024/10/4	10:38:19	839	26.22	25.62	25.63	25.57	26.75	25.61	26.5406	0.0922
27	9.837	2024/10/4	10:38:20	837	26.16	25.63	25.63	25.67	26.77	25.66	26.5406	0.0922
28	10.837	2024/10/4	10:38:21	837	26.25	25.69	25.68	25.67	26.79	25.63	26.5405	0.0922
29	11.84	2024/10/4	10:38:22	840	26.13	25.6	25.56	25.63	26.72	25.58	26.5405	0.0921
30	12.837	2024/10/4	10:38:23	837	26.23	25.61	25.62	25.62	26.77	25.64	26.5405	0.0922

Elapsed time from starting time, measured date and results of CH1 to CH8 will be outputted.

# Chapter 8 Save and Load of the Data

## 8.1 Storage device

An SD/SDHC card or USB flash drive can be used as a storage device, and measurement data and setting data can be saved to it.

Optional SD/SDHC cards (SD-8GX, SD-16GX, SD-32GX, sold by LINEEYE) are available. You can use a USB flash drive, but we do not guarantee the operation of all USB flash drives.

The measurement data automatically saved in the storage device using the trigger function or auto save function is saved in the storage device specified in advance by “Save device” at “Auto save” tab of “Record control” in [MENU].

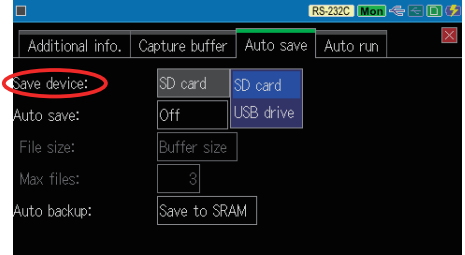

You can save a screenshot of the screen to the storage device by pressing [ESC] while pressing [SHIFT].

2.7 System Menu

It is also possible to save text files in the continuous printing format of the measurement data on the storage device.

8.3 Text conversion and printing function of measurement data

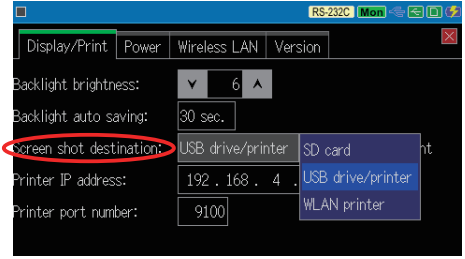

## 8.2 File Management Function

You can save, read, and delete the measured data and setting data in the storage device as a file that can be read/written by a PC. Set the storage device to this analyzer and display the top menu by [MENU] and touch “File operation” at the bottom of the screen, or touch “File operation” from the operation menu [≡] at the lower left of the data display screen to display the directory screen.

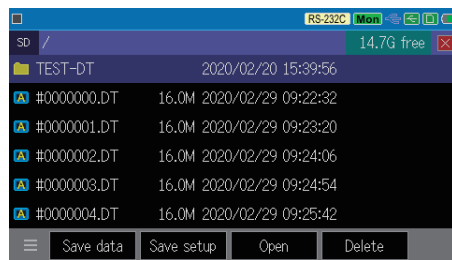
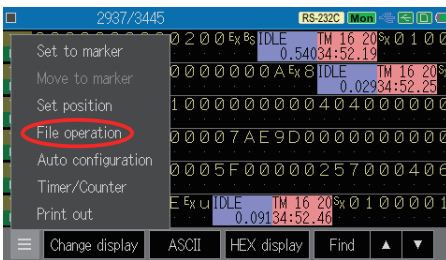

When both SD/SDHC card and USB flash drive are set, touch “Change device” from the operation menu [≡] at the lower left of the directory screen to switch to the directory screen of the storage device to be managed.

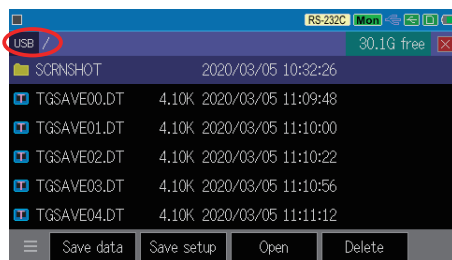
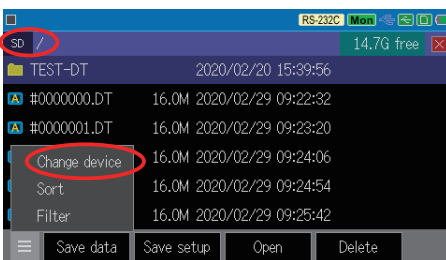

- The file types are as follows.

Extension	Content
DT	Measured data
SU	Setting data (including the data tables and simulation programs)

- 📄 The file saved by the auto save function is #nnnnnnn.DT (n is a serial number starting from 0). Displayed as “ **A** ”.
- 📄 The file saved by the trigger save function is TGSAVEnn.DT (n is a sequential number starting from 0). Displayed as “ **T** ”.

📖 6.1 Trigger Function

📖 6.5 Auto Save Function

## 📖 Save data

When you touch “Save data” on the directory screen, the full key image and text input window will be displayed on the screen. Touch the full key on the screen to enter the file name and touch “OK” or press [ENTER] to save all measurement data in the capture memory and return to the directory screen. The measurement data file extension DT is automatically added.

- 📄 The file name can be specified with up to 8 characters. You cannot enter lowercase letters.

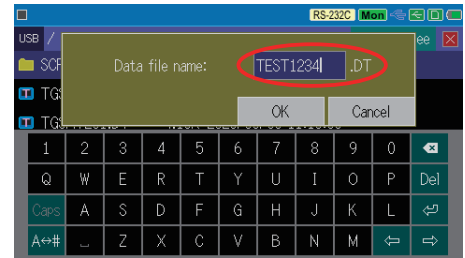

## 📖 Save setup

When you touch “Save setup” on the directory screen, the full key image and the text input window will be displayed on the screen. Touch the full key on the screen to enter the file name, and then touch “OK” or press [ENTER] to save all setting data of the top menu and return to the directory screen. The file extension SU of the setting data is automatically added.

- 📄 You can enter the symbols that can be used as the file name by touching “A<->#”.
- 📄 The “System settings” display and power and Wi-Fi settings are not saved in the setting data file.

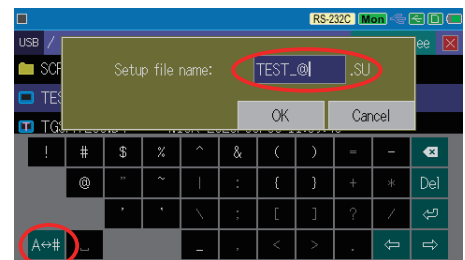

Never remove the storage device while it is accessing files.

## 📖 File sorting and display filters

Files on the directory screen can be scrolled and displayed by swiping the screen or [▼] and [▲].

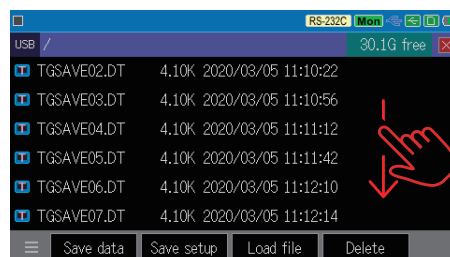
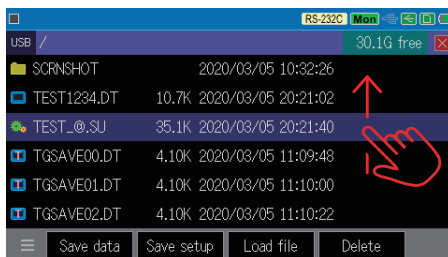

◆ Sort

You can touch the “Sort” from the operation menu “☰” at the bottom left of the directory screen, you can sort and display in ascending or descending order by specifying the file name, extension, size, and update date and time.

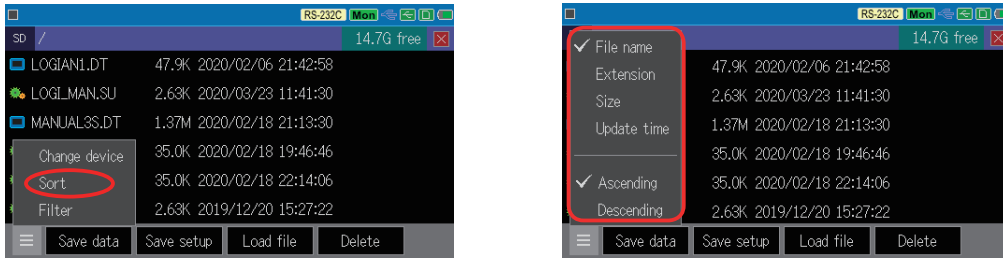

☰ The sorting settings will return to the initial state when the power is turned back on.

◆ Filter

Touch “Filter” from the operation menu [☰] at the bottom left of the directory screen, specify the file type and update date and time range (file timestamp), and touch “Apply” to display only the specified files.

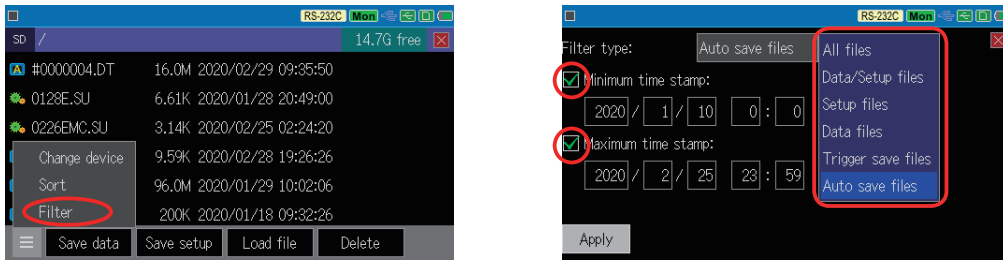

The following file types can be specified for the filter display.

- All files
- Analyzer measurement data file and setting data file
- Analyzer setting data file
- Analyzer measurement data file
- File automatically saved by the trigger function (TGSAVEnn.DT)
- File automatically saved by the auto save function (#nnnnnnn.DT)

When specifying the time stamp range of the file, check [☑] and enter the date and time.

When it is specified with the file type, only the files of the specified type saved in the specified period are displayed. The background color of the filtered directory screen changes.

☰ The filter display will be canceled if you move to another screen with [ESC] or remove the storage medium that is being displayed. You can also cancel it by touching “Filter” again in the operation menu.

## Load file

On the directory screen, touch the file you want to load or select with [▼] or [▲] and touch “Load” to load the data of the file. When you load the setting data file, the measurement conditions will be updated to the menu screen. When the measurement data file is loaded, the original measurement data will be cleared and the loaded measurement data will be displayed. Please note that the current settings and data in the capture buffer will be overwritten just by touching “Load”.

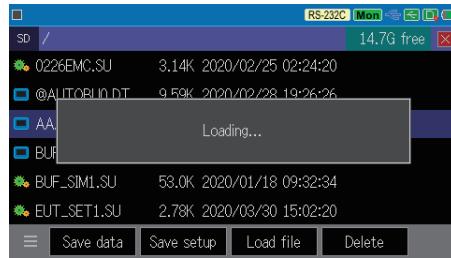
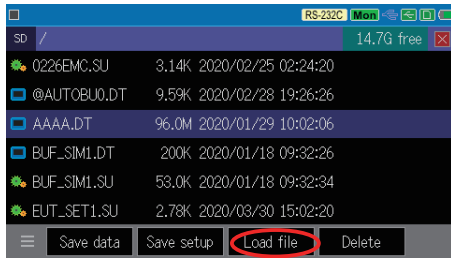

 You can also double-tap the selected file, or press [ENTER] and then touch “OK” in the confirmation window (or press [ENTER] again) to load the file data.

 Files with extensions other than DT and SU cannot be loaded.

### ◆ Loading the file in subdirectory

On the directory screen, touch the subdirectory (hereafter, folder) that contains the file you want to load, or select with [▼], [▲] and touch “Open” to display the files in that folder. Select the file and execute the load operation. Select “ ..” and touch “Open” to move to the upper directory.

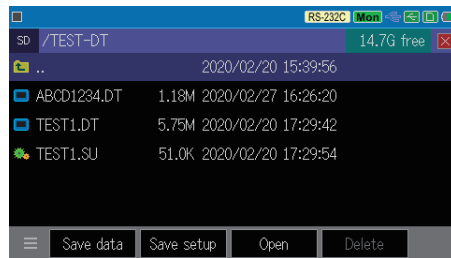
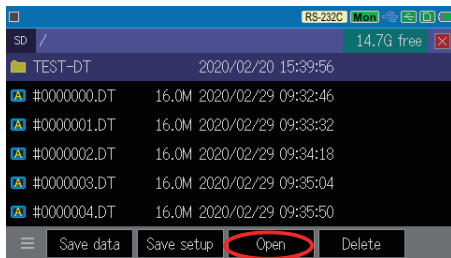

 You cannot create folders or move files between folders. This kind of operation needs to be performed on a PC.

## Delete a file

### ◆ Delete a file

On the directory screen, touch the file you want to delete, or select it with [▼] or [▲] and touch "Delete", and then touch “OK” (or [ENTER]) in the confirmation window to delete the file. To cancel the deletion, touch “Cancel” at the confirmation.

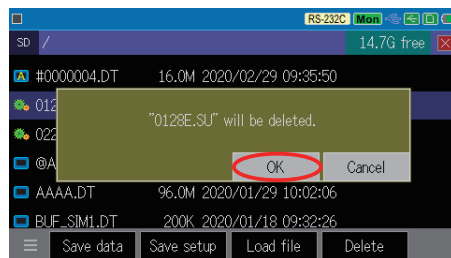
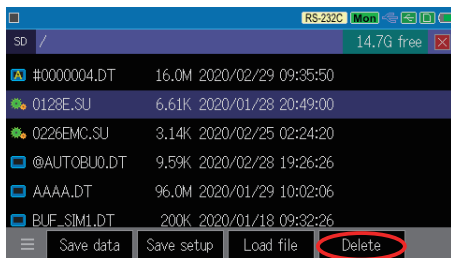

◆ Delete multiple files at the same time

Touch the file display on the directory screen, or select with [▼] [▲] and long-tap the file (touch for about 1 second) to be the file selection display. Touch  (or [ENTER]) the file you want to delete and a check mark will be added to it. Touch the selected file again to deselect it. Touch “Delete” and then touch “OK” (or [ENTER]) in the confirmation window to delete the selected files. To cancel the deletion, touch “Cancel” at the confirmation.

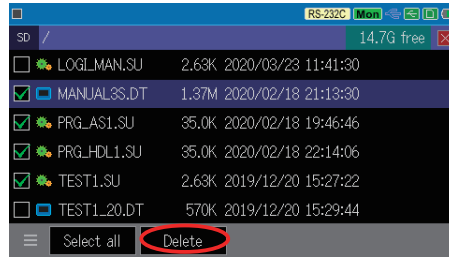
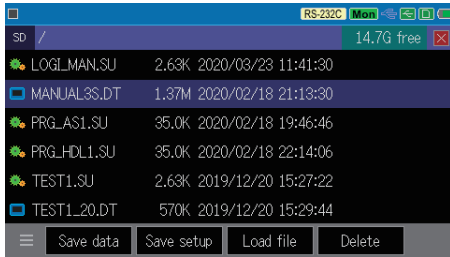

◆ Delete all the files

In the file selection display, touch “Select all” to select all the files displayed in the directory screen. Touch “Delete” and then “OK” (ore press [ENTER]) in the confirmation window to delete all the files. When you want to delete all the specified files, for example, only the files automatically saved by the trigger function (TGSAVEnn.DT), you can do so by using the filter display of the files.

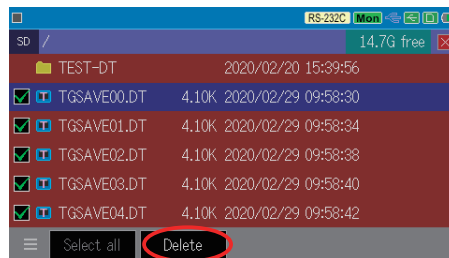
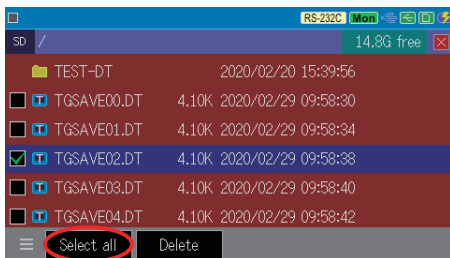

 Long tap again or press [ESC] to return to the original display and cancel the selection.

## Error message

If an error message is displayed when accessing the storage device, take appropriate action.

■ Exchange SD card / USB flash drive.

When x is displayed on the storage device mark or when a message indicating that the device is unavailable is displayed.

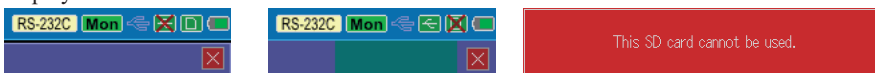

The storage device is not recognized properly. If the problem cannot be solved by removing and inserting the storage device again, replace it with another storage device.

■ Release the SD card protect switch

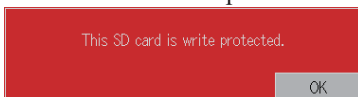

Try turning the small switch on the side of the SD card to the opposite side.

■ Check the file to be loaded

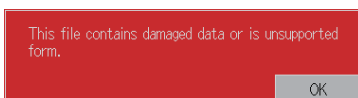

This message appears when it cannot load the data because the data structure is different although the extension is DT or SU, or the data structure is damaged. This message will also be displayed when you try to load an incompatible file, such as a file saved when using the CAN/LIN measurement option, or an analog measurement data file when operating as a communications analyzer.



## 8.3 Text conversion and printing function of measurement data

You can convert the measurement data to text in various formats corresponding to the screen display mode and save it to the storage device. If you prepare a dedicated printer, you can continuously print the measurement data in the same format.

### Text conversion and its saving of the measurement data

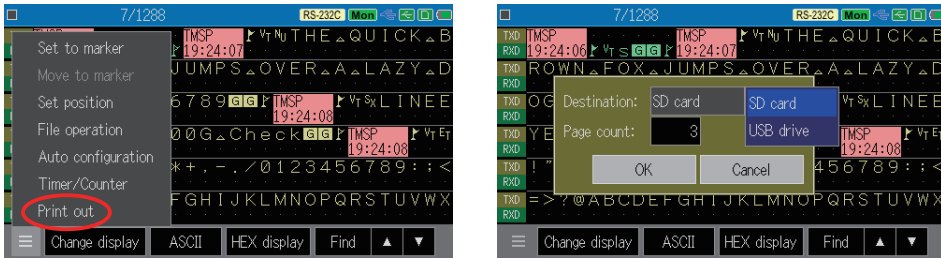
- 1) Insert the SD card or USB memory to which you want to save the text conversion file into this unit.
- 2) Display the measurement data that you want to print on the screen by scrolling and the search function.
- 3) In the [≡] menu at the bottom left of the measurement data display screen, touch “Print out” and select “SD card” or “USB drive” for the output destination according to the set storage device.



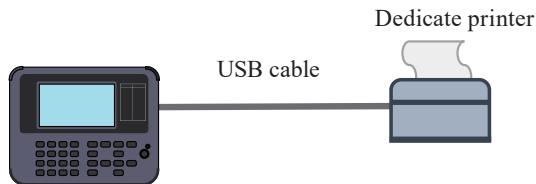

- 4) Specify the printing range from the current display screen.  
66 lines are converted and stored on one page.  
 As the conversion ends with the specified range or at the final measurement data, enter a large number such as 99999 if you want to convert it until the end of the measurement data.
- 5) Click “OK” to save a text file corresponding to the screen display mode to the PRINTOUT folder of the specified device.  
 It is saved as the text file name “ddhhmss.txt” (Day, Hour, Minute, Second of when it is saved).

### When printing via USB

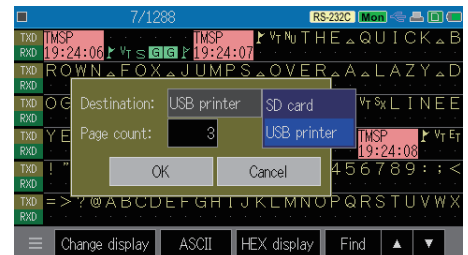

- 1) Connect the USB host port of the analyzer and the dedicated printer with the included USB cable.
- 2) Display the measurement data that you want to print on the screen by scrolling and the search function.
- 3) In the [≡] menu at the bottom left of the measurement data display screen, touch “Print out” and select “USB printer” for the output destination.
- 4) Specify the printing range from the current display screen.



-  66 lines are printed on one page. Please note that if you specify the print range too much, it will consume a large amount of paper.

5) Click “OK” to start printing in a format corresponding to the screen display mode.

- ☰ If you touch the “Cancel” during printing, the output of the print data will be discontinued, but the amount taken in the buffer memory of the printer will not be canceled. If you want to stop printing immediately, turn off the power of the printer.

## 📖 When printing via Wi-Fi

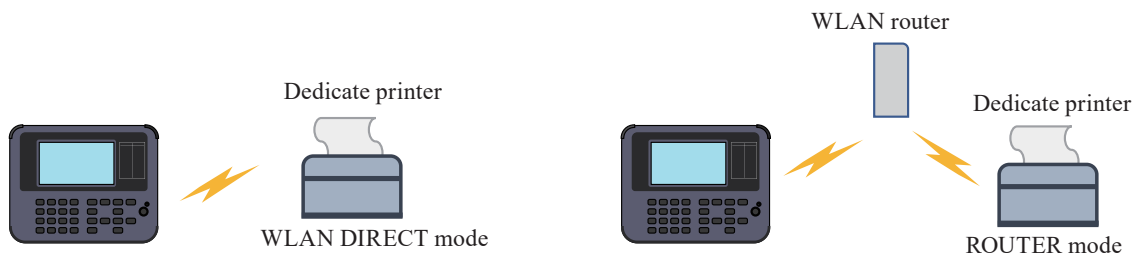

- 1) mode in which the printer itself works as a Wi-Fi access point for the printer itself. The following explanation is based on this mode.
  - ☰ When the printer setting is changed to Router mode, you need to connect both this unit and the printer to a Wi-Fi router. See the printer’s instruction manual for how to set the printer for it.
- 2) In the wireless LAN tab of the “System Settings” of this unit, set “Station” to the mode item and input “SANEI-ELEC-AP” to the SSID item. The setting for the password is not required.
- 3) Check the DHCP box, click “Apply” and connect to a dedicated printer.
- 4) Start printing by operating in the same way as USB connection. At that time, make sure that the output destination is a “WLAN printer”.

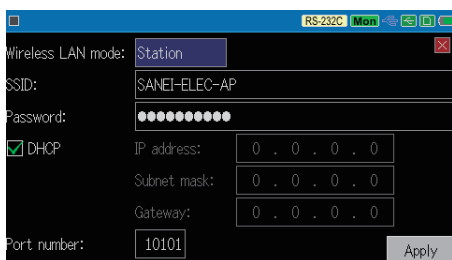

## 📖 Print/text conversion format of measurement data

One measurement data is converted to HEX and two-line and four characters.

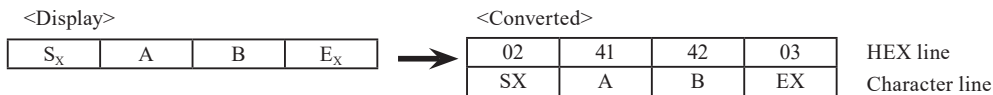

- ◆ If the character code is undefined or “△” (space code), nothing is converted to the character line.
- ◆ If there is no data, “-” is converted to HEX line.
- ◆ Time information and line state of control line are converted as follows.

Idle time	[IDLE] [0020]	Line state	H “11” L “00” H -> L “10” L -> H “01”
Time stamp	[TMSP]		
3 units (hour, minute, second etc.)	[051735]		
Time stamp	[T 2314]		
5 units (day, hour, minute, second, 10ms etc.)	[321257]		





### ◆ BERT repeat measurement

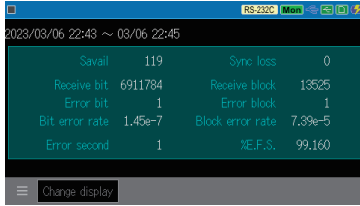

```

*=[LE-2500XR(V2)]===[2023-03-07 00:01:32]===== *
* Model      : LE-2500XR(V2)                       *
* Version    : 2.00                                 *
* Extension   : Standard                             *
* Serial No. : 99999999                              *
* Start time  : 2023-03-06 22:43:21                  *
* Stop time   : 2023-03-06 23:59:58                  *
-----*
* BERT RESULTS                                       *
* PROTOCOL: SYNC                                     *
* TX-SPEED: 57600  RX-SPEED: 57600                   *
* CLOCK      : AR                                     *
-----*

```

DATE-TIME	LOSS	R-BIT	E-BIT	BIT-ER	E-BLK	BLK-ER	E-SEC	%E.F.S
03/06 22:43	0	6911784	1	1.45E-7	1	7.39E-5	1	99.160
03/06 22:45	0	6911808	3	4.34E-7	3	2.22E-4	3	97.479
03/06 22:47	0	6912152	7	1.01E-6	3	2.22E-4	3	97.479
03/06 22:49	0	6911808	0	0.00E+0	0	0.00E+0	0	100.000
03/06 22:51	0	6912152	0	0.00E+0	0	0.00E+0	0	100.000
03/06 22:53	0	6912152	0	0.00E+0	0	0.00E+0	0	100.000
03/06 22:55	0	6911808	0	0.00E+0	0	0.00E+0	0	100.000
03/06 22:57	0	6911816	0	0.00E+0	0	0.00E+0	0	100.000
03/06 22:59	0	6912152	0	0.00E+0	0	0.00E+0	0	100.000
03/06 23:01	0	6912152	0	0.00E+0	0	0.00E+0	0	100.000
03/06 23:03	0	6911808	11	1.59E-6	3	2.22E-4	3	97.479
03/06 23:05	0	6911816	12	1.74E-6	4	2.96E-4	4	96.639
03/06 23:07	0	6912152	0	0.00E+0	0	0.00E+0	0	100.000
03/06 23:09	0	6912152	0	0.00E+0	0	0.00E+0	0	100.000
03/06 23:11	0	6911808	0	0.00E+0	0	0.00E+0	0	100.000
03/06 23:13	0	6911816	0	0.00E+0	0	0.00E+0	0	100.000
03/06 23:15	0	6912152	0	0.00E+0	0	0.00E+0	0	100.000
03/06 23:17	0	6912152	8	1.16E-6	4	2.96E-4	2	98.319
03/06 23:19	0	6911808	0	0.00E+0	0	0.00E+0	0	100.000
03/06 23:21	1	6816883	203	2.98E-5	4	3.00E-4	2	98.319

### ◆ TREND measurement

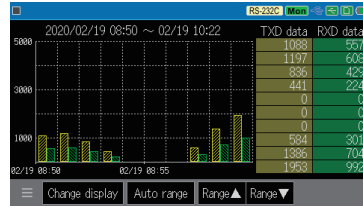

```

*=[LE-3500XR(V2)]===[2023-03-08 17:11:24]===== *
* Model      : LE-3500XR(V2)                       *
* Version    : 2.00                                 *
* Extension   : Standard                             *
* Serial No. : 99999999                              *
* Start time  : 2023-03-06 08:50:09                  *
* Stop time   : 2023-03-06 10:22:03                  *
-----*
* TREND RESULTS                                       *
* PROTOCOL: HDLC                                     *
* TX-SPEED: 1M  RX-SPEED: 1M                         *
* CODE      : ASCII  FCS      : FCS16                 *
* FORMAT    : NRZ    CLOCK    : AR                     *
* TX-ADDR   : *      RX-ADDR   : *                     *
-----*

```

DATE-TIME	TXD-DATA	RXD-DATA
02/19 08:50	1088	557
02/19 08:51	1197	608
02/19 08:52	836	429
02/19 08:53	441	224
02/19 08:54	0	0
02/19 08:55	0	0
02/19 08:56	0	0
02/19 08:57	584	301
02/19 08:58	1386	704
02/19 08:59	1953	992
02/19 09:00	4536	2304
02/19 09:01	4662	2368
02/19 09:02	4427	2253
02/19 09:03	4788	2432
02/19 09:04	5040	2560
02/19 09:05	5326	2714
02/19 09:06	6649	3386
02/19 09:07	8127	4128

### ■ Hard copy (screenshot) print example

To print, press [SHIFT]+[ESC] while the dedicated printer is ready.

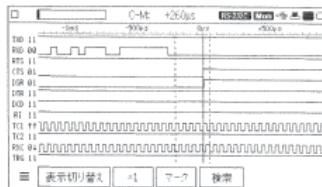

When Expanded print is selected, the printing is enlarged vertically.



### 2.7 System Settings (Screenshot output destination)

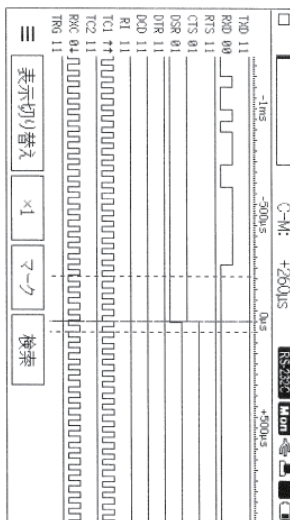

As the color display is printed in black and white, the grayed out selection items and other pale colors may not be printed.

# Chapter 9 PC Link

## 9.1 PC link software

You can save, display, and convert the analyzer data on your PC.

### ■ USB connection

Connect the analyzer's USB device port and PC with a USB cable.

### ■ Wi-Fi connection

Select station mode or access point mode at the wireless LAN settings tab of “System Settings” in [MENU] and set the SSID and password required for Wi-Fi connection.

 2.7 System Settings( Wi-Fi Setting)

### ■ Installation of the PC link software

PC link software has a product version and a “lite version” with some functional restrictions.

The “lite version” can be downloaded free of charge from the LINEEYE website. Unzip the downloaded file, run setup.exe in that folder, and install according to the instructions of the installation wizard. Installation instructions for a product version are provided in the instruction manual attached to PC link software.

### ■ How to use the PC link software

For information on how to use the PC link software, refer to the instruction manual attached to the PC link software or the online help for the PC link software.

### ■ Key emulation example

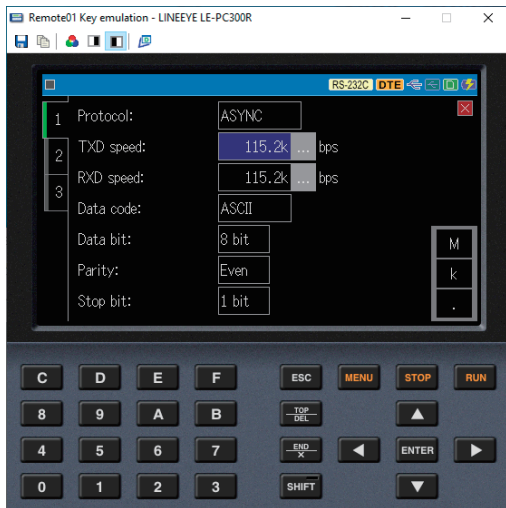



## 9.2 Usage of Screenshot

The screenshot is saved as a bitmap file (extension: BMP), so you can use it by softwares which supports bitmap file.

### ■ Usage example

- 1) Connect the storage device that stores the screenshot file to your computer.
- 2) Open the SCRNSHOT folder of the storage device by the explorer.
- 3) Select “Oversized Icon” from “Display” on the explorer toolbar to check the saved screen image.
- 4) Drag the screenshot file you want to use and paste it in a word or Excel to use as measurement data for the report.

 The name of the screenshot file is the date, time, minutes, seconds, (when the file was saved) and .BMP.

## 9.3 Take the data file while measurement

### LE file downloader

You can use the LE file downloader to download the communication log file saved in the storage device by the analyzer's auto save function to your computer via Wi-Fi. You can execute the auto save function by the analyzer set on site and import the communication log file of the time stamp around the time when the communication failure occurred to the PC, and analyze it with the PC link software.

 The LE file downloader can transfer only the files of the measurement data files with the name #nnnnnnn.DT (n is a serial number starting from 0) saved by the auto save function.

### How to use

- 1) Download and unzip the LE file downloader (lefiledownload.exe) Ver.1.03 or later from the Line Eye website to an appropriate folder on your computer. No installation required.
- 2) Make sure that the analyzer and PC can be connected via Wi-Fi.

### 2.7 System Settings( Wi-Fi Setting)

- 3) Execute the auto save function.
- 4) Double-click lefiledownload.exe to start it, enter the IP address and port number of the analyzer, and click “Connect”.
- 5) The communication log file saved by the auto save function is displayed in the list window. Click “Update list” to redisplay the latest status in the list window.
- 6) Click  to specify the save destination, and select the communication log file to be imported to the PC referring to the time stamp of the file.
- 7) Click “Download” to start transfer to the specified save destination via Wi-Fi and. It may take 2 minutes or more to transfer a 16Mbyte file depending on the load on the analyzer measurement process and the radio wave condition.
- 8) Read the downloaded communication log file into the PC link software LE-PC300R and analyze it. Select the connection by LE-PC300R.

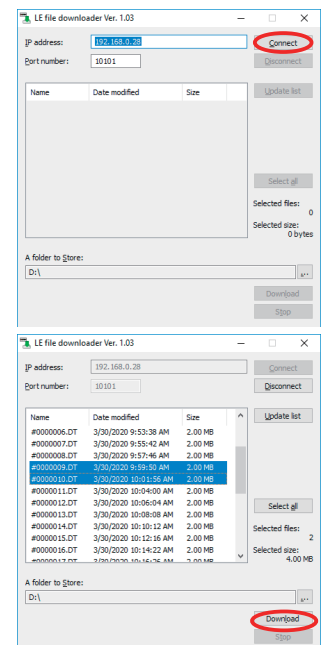

## 9.4 Key Emulation Software

---

The software which can emulate key operation while confirming the screen of the analyzer on the PC is prepared. Remote operation is possible for a sense to operate an actual analyzer. This emulation software (LE-PCKEYEMU) is available from LINEEYE webpage.

## 9.5 PC Remote Control Library

---

The libraries for Windows and Linux are available to make a user application software which remotely control the analyzer from a PC. The library can be downloaded from the LINE EYE website.

■ For Windows

Windows 10/11, VC++6.0 and VC++.NET are supported.

■ For Linux

Some distributions are supported \*

\*: Supported partly a fee. Contact LINEEYE for the detail.

📄 It is operation verification by our environment and does not guarantee a correct operation in the above environment.

## 10.1 Calculation of the Block Check

The block check is executed as follows.

■ For ASYNC, SYNC, and BSC

- Calculation : When it receives a calculation result by “ITB code ” or a character set at “Begin code” of start “BCC” in the “Configuration”, it starts calculation from the next character.
- Calculation : When it receives either the “ITB code ” or the character set at “End code” of “BCC” in the end configuration it finishes the calculation including that character.
- BCC judgment : When the calculation end character is received after the calculation start character is received, the next data of the calculation end character is checked as BCC.

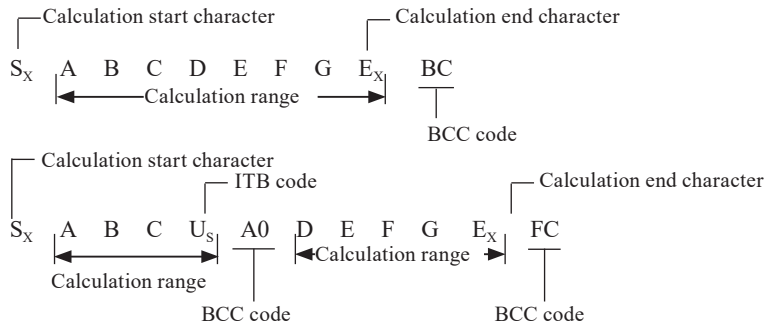

When transparent mode

- If you check “Transparent mode” at “BCC” in the “Configuration”, it calculate “BCC” as transparent mode.
- The character set to “DLE code” is treated as a Data Link Escape code (hereafter, DLE).
- The received frame that starts with DLE + calculation start code has the calculation range up to DLE + calculation end code, and the calculation end code without DLE is treated as a normal character.
- DLE is excluded from BCC calculation. However, if two DLEs continue, the second DLE is treated as a normal character and is therefore subject to BCC calculation.
- Synchronization code without DLE is treated as a normal character, and synchronization code with DLE is excluded from the calculation.

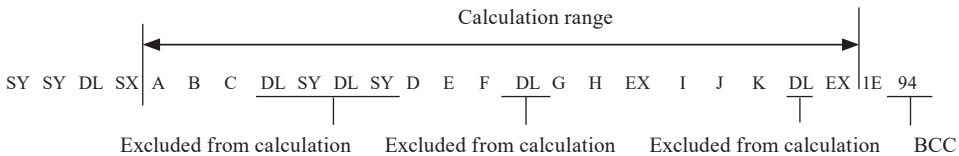

■ For HDLC and SDLC

- Calculation start: After the flag synchronization is established, it starts the calculation from the first received data.
- Calculation end: It calculates up to the character immediately before the sync release flag.
- FCS judgment: The character immediately before the sync release flag is checked as FCS.

■ For MODBUS

The calculation range is from the address field to data field.

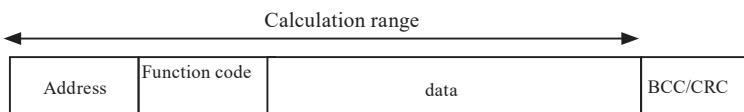

## ■ Reference

### • LRC code

LRC odd : horizontal parity odd

LRC even : horizontal parity even (usually 'LRC even' is used.)

### • CRC generator polynomial

CRC-6 :  $X^6+X^5+1$

CRC-12 :  $X^{12}+X^{11}+X^3+X^2+X+1$

CRC-16 :  $X^{16}+X^{15}+X^2+1$

CRC-ITU-T :  $X^{16}+X^{12}+X^5+1$

### • FCS generator polynomial

FCS-16 :  $X^{16}+X^{12}+X^5+1$

FCS-32 :  $X^{32}+X^{26}+X^{23}+X^{22}+X^{16}+X^{12}+X^{11}+X^{10}+X^8+X^7+X^5+X^4+X^2+X+1$

(All 1 initial)

## 10.2 Send/Receive Clock

In synchronous communication (SYNC/BSC, HDLC/SDLC), when transmitting/receiving data in synchronization with an external clock, there are three patterns of DTE/DCE send/receive clocks as shown below. When monitoring and testing synchronous communication with this analyzer, set the "Clock" of the configuration appropriately according to the specifications of the communication device.

### ■ DTE sends data in sync with its ST1 (TXC1) clock.

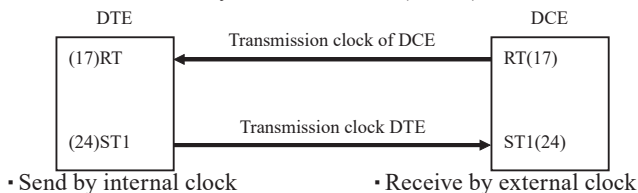

### ■ DTE sends data in sync with DCE's ST2 (TXC2) clock.

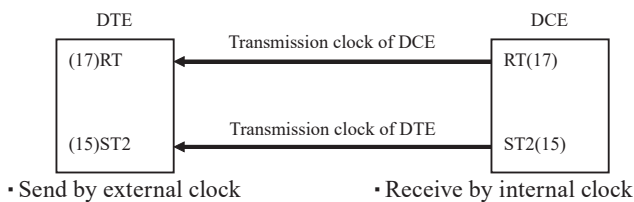

### ■ DTE sends data in sync with DCE's RT (RXC) clock.

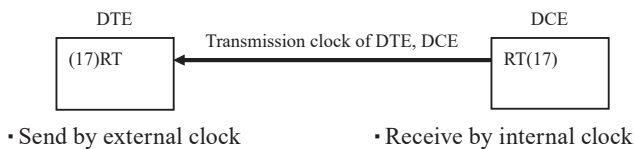

### ◇ Use of AR (Auto Regulation)

In synchronous communication using a line that does not use a clock line, such as RS-485, changes in received data are detected to take the phase synchronization and receive. If you select "AR" at "Clock" of "Configuration" of this analyzer, you can also extract the synchronous clock from the received data without using an external clock and capture the data. The "Communication speed" of "Configuration" must match the communication speed of the target device.

### ◇ ST1, ST2, RT selection

By selecting the "Clock" (ST1, ST2, RT) of the configuration of the analyzer as shown in the figure below, you can monitor the synchronous communication using the external clock and perform the simulation and BERT on the DTE side or DCE side.

■ When monitoring in synchronization with an external clock.

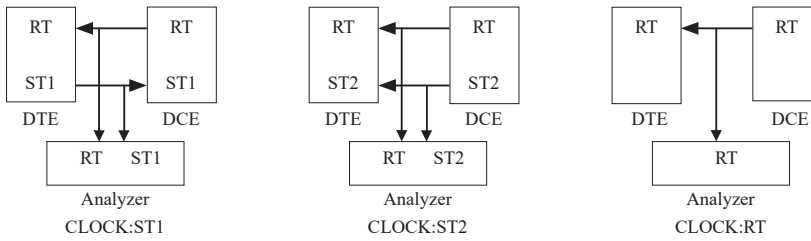

■ When performing a simulation with DCE (this unit is in DTE mode).

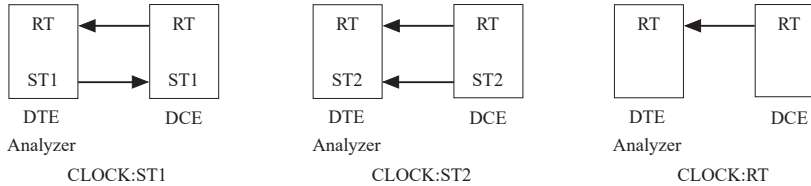

■ When performing a simulation with DTE (this unit is in DCE mode).

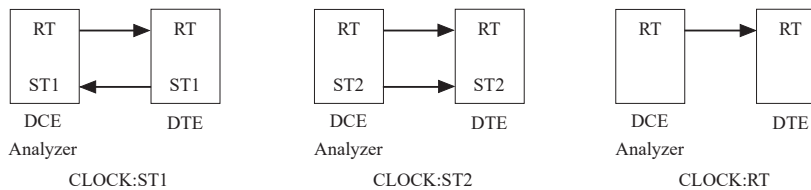

### 10.3 About the Frame

The definition of 1 frame is as shown in the table below for each protocol.

Protocol	Definition of 1 frame
ASYNC	Data string until the idle time longer than one set at “Frame end time” in the configuration is detected or the data set at “Frame end code” is received.
SYNC • BSC	Data string from the synchronization establishment character set at “Sync code” in the configuration to the synchronization release character set at “Reset code”.
HDLC • SDLC	Data string from start flag to end flag.
ASYNC-PPP	Data string from flag character (7Eh) to flag character (7Eh).
MODBUS	In RTU mode, the data string until detecting the non-communication time of silent interval (3.5 characters) or more. In ASCII mode, Data string from start code (3Ah) to end code (0Dh, 0Ah).
I2C	Data sequence from start sequence detection to stop sequence detection.
SPI	Data string received while the SS signal is active.
Burst	Data string until an idle time set at “Frame end time” in the configuration or more is detected.

# 10.4 Data Code Chart

- Blank parts (undefined code parts) are displayed in HEX.
- JIS (data bit: 7-bit length), EBCDIC, and Baudot switches between SHIFT IN display and SHIFT OUT display by the shift-in character SI and shift-out character SO.
- The monitor display immediately after the start of measurement starts from the SHIFT IN display.
- SI is preceded and remains SHIFT IN display until the next SO appears.
- SO precedes and remains SHIFT OUT display until the next SI appears.

## ■ ASCII

	0	1	2	3	4	5	6	7
0	NU	DL	Δ	0	@	P	`	p
1	SH	D1	!	1	A	Q	a	q
2	SX	D2	”	2	B	R	b	r
3	EX	D3	#	3	C	S	c	s
4	ET	D4	\$	4	D	T	d	t
5	EQ	NK	%	5	E	U	e	u
6	AK	SY	&	6	F	V	f	v
7	BL	EB	'	7	G	W	g	w
8	BS	CN	(	8	H	X	h	x
9	HT	EM	)	9	I	Y	i	y
A	LF	SB	*	:	J	Z	j	z
B	VT	EC	+	;	K	[	k	{
C	FF	FS	,	<	L	\	l	
D	CR	GS	-	=	M	]	m	}
E	SO	RS	.	>	N	^	n	~
F	SI	US	/	?	O	_	o	DT

## ■ EBCDIC

	0	1	2	3	4	5	6	7	8	9	A	B	C	D	E	F
0	NU	DL	DS		Δ	&	-						{	}	\	0
1	SH	D1	SS				/		a	j	~		A	J		1
2	SX	D2	FS	SY					b	k	s		B	K	S	2
3	EX	D3	WS	IR					c	l	t		C	L	T	3
4	PF	RE	BP	PN					d	m	u		D	M	U	4
5	HT	NL	LF	TN					e	n	v		E	N	V	5
6	LC	BS	EB	NS					f	o	w		F	O	W	6
7	DT	PC	EC	ET					g	p	x		G	P	X	7
8	GE	CN	SA	S2					h	q	y		H	Q	Y	8
9	SI	EM	SE	IT					i	r	z		I	R	Z	9
A	RT	US	SM	RF	ϕ	!		:								
B	VT	C1	CP	C3	.	\$	,	#								
C	FF	IF	MA	D4	<	*	%	@								
D	CR	IG	EQ	NK	(	)	_	'								
E	SO	RS	AK		+	;	>	=								
F	SI	IB	BL	SB		-	?	^								

■ JIS (Data bit: 7-bit length)

For Roman characters

SHIFT IN

	0	1	2	3	4	5	6	7
0	NU	DL	△	0	@	P	`	p
1	SH	D1	!	1	A	Q	a	q
2	SX	D2	”	2	B	R	b	r
3	EX	D3	#	3	C	S	c	s
4	ET	D4	\$	4	D	T	d	t
5	EQ	NK	%	5	E	U	e	u
6	AK	SY	&	6	F	V	f	v
7	BL	EB	’	7	G	W	g	w
8	BS	CN	(	8	H	X	h	x
9	HT	EM	)	9	I	Y	i	y
A	LF	SB	*	:	J	Z	j	z
B	VT	EC	+	;	K	[	k	{
C	FF	FS	,	<	L	¥	l	
D	CR	GS	-	=	M	]	m	}
E	SO	RS	.	>	N	^	n	~
F	SI	US	/	?	O	_	o	DT

For Kana characters

SHIFT OUT

	0	1	2	3	4	5
0	NU	DL	△	-	タ	ミ
1	SH	D1	。	ア	チ	ム
2	SX	D2	「	イ	ツ	メ
3	EX	D3	」	ウ	テ	モ
4	ET	D4	、	エ	ト	ヤ
5	EQ	NK	・	オ	ナ	ユ
6	AK	SY	ヲ	カ	ニ	ヨ
7	BL	EB	ァ	キ	ヌ	ラ
8	BS	CN	ィ	ク	ネ	リ
9	HT	EM	ゥ	ケ	ノ	ル
A	LF	SB	ェ	コ	ハ	レ
B	VT	EC	ォ	サ	ヒ	ロ
C	FF	FS	ャ	シ	フ	ワ
D	CR	GS	ュ	ス	ヘ	ン
E	SO	RS	ョ	セ	ホ	゜
F	SI	US	ッ	ソ	マ	。

■ JIS(Data bit: 8-bit length)

	0	1	2	3	4	5	6	7	8	9	A	B	C	D	E	F
0	NU	DL	△	0	@	P	`	p				-	タ	ミ		
1	SH	D1	!	1	A	Q	a	q				。	ア	チ	ム	
2	SX	D2	”	2	B	R	b	r				「	イ	ツ	メ	
3	EX	D3	#	3	C	S	c	s				」	ウ	テ	モ	
4	ET	D4	\$	4	D	T	d	t				、	エ	ト	ヤ	
5	EQ	NK	%	5	E	U	e	u				・	オ	ナ	ユ	
6	AK	SY	&	6	F	V	f	v				ヲ	カ	ニ	ヨ	
7	BL	EB	’	7	G	W	g	w				ァ	キ	ヌ	ラ	
8	BS	CN	(	8	H	X	h	x				ィ	ク	ネ	リ	
9	HT	EM	)	9	I	Y	i	y				ゥ	ケ	ノ	ル	
A	LF	SB	*	:	J	Z	j	z				ェ	コ	ハ	レ	
B	VT	EC	+	;	K	[	k	{				ォ	サ	ヒ	ロ	
C	FF	FS	,	<	L	¥	l					ャ	シ	フ	ワ	
D	CR	GS	-	=	M	]	m	}				ュ	ス	ヘ	ン	
E	SO	RS	.	>	N	^	n	~				ョ	セ	ホ	゜	
F	SI	US	/	?	O	_	o	DT				ッ	ソ	マ	。	

■ EBCDIK

	0	1	2	3	4	5	6	7	8	9	A	B	C	D	E	F
0	NU	DL	DS		△	&	-			ソ			{	}	\	0
1	SH	D1	SS				/		ア	タ	~		A	J		1
2	SX	D2	FS	SY					イ	チ	へ		B	K	S	2
3	EX	D3	WS	IR					ウ	ツ	ホ		C	L	T	3
4	PF	RE	BP	PN					エ	テ	マ		D	M	U	4
5	HT	NL	LF	TN					オ	ト	ミ		E	N	V	5
6	LC	BS	EB	NS					カ	ナ	ム		F	O	W	6
7	DT	PC	EC	ET					キ	ニ	メ		G	P	X	7
8	GE	CN	SA	S2					ク	ヌ	モ		H	Q	Y	8
9	SI	EM	SE	IT					ケ	ネ	ヤ		I	R	Z	9
A	RT	US	SM	RF	¢	!	:	:	コ	ノ	ユ	レ				
B	VT	C1	CP	C3	.	¥	,	#				ロ				
C	FF	IF	MA	D4	<	*	%	@	サ		ヨ	ワ				
D	CR	IG	EQ	NK	(	)	_	'	シ	ハ	ラ	ン				
E	SO	RS	AK		+	;	>	=	ス	ヒ	リ	ゝ				
F	SI	IB	BL	SB		-	?	"	セ	フ	ル	°				

■ Baudot

SHIFT IN

	0	1
0	NU	T
1	E	Z
2	LF	L
3	A	W
4	△	H
5	S	Y
6	I	P
7	U	Q
8	CR	O
9	D	B
A	R	G
B	J	SO
C	N	M
D	F	X
E	C	V
F	K	SI

SHIFT OUT

	0	1
0	NU	5
1	3	”
2	LF	)
3	-	2
4	△	#
5	'	6
6	8	0
7	7	1
8	CR	9
9	\$	?
A	4	&
B	BL	SO
C	,	.
D	!	/
E	:	;
F	(	SI

■ EBCD

SHIFT IN

	0	1	2	3
0	△	2	1	3
1	-	k	j	l
2	@	s	/	t
3	&	b	a	c
4	8	0	9	#
5	q	VT	r	\$
6	y	FF	z	,
7	h		i	.
8	4	6	5	7
9	m	o	n	p
A	u	w	v	x
B	d	f	e	g
C		SO	RS	ET
D		BS	CR	SY
E		EB	LF	EC
F		SI	HT	DT

SHIFT OUT

	0	1	2	3
0	△	<	=	;
1	_	K	J	L
2		S	?	T
3	+	B	A	C
4	*	)	(	”
5	Q	VT	R	!
6	Y	FF	Z	,
7	H		I	.
8	:	,	%	>
9	M	O	N	P
A	U	W	V	X
B	D	F	E	G
C		SO	RS	ET
D		BS	CR	SY
E		EB	LF	EC
F		SI	HT	DT

■ Transcode

	0	1	2	3
0	SH	&	_	0
1	A	J	/	1
2	B	K	S	2
3	C	L	T	3
4	D	M	U	4
5	E	N	V	5
6	F	O	W	6
7	G	P	X	7
8	H	Q	Y	8
9	I	R	Z	9
A	SX	△	EC	SY
B	.	\$	,	#
C	<	*	%	@
D	BL	US	EQ	NK
E	SB	ET	EX	EM
F	EB	DL	HT	DT

■ IPARS

	0	1	2	3
0			@	\$
1	1	/	J	A
2	2	S	K	B
3	3	T	L	C
4	4	U	M	D
5	5	V	N	E
6	6	W	O	F
7	7	X	P	G
8	8	Y	Q	H
9	9	Z	R	I
A	0	-	:	?
B	*	#	<	.
C	CR	△	+	%
D	EI	EC	EU	EP
E	=	[	)	S2
F		,	(	S1

# 10.5 Translation Display Specification

## Frame level translation display

### SDLC, HDLC fram composition

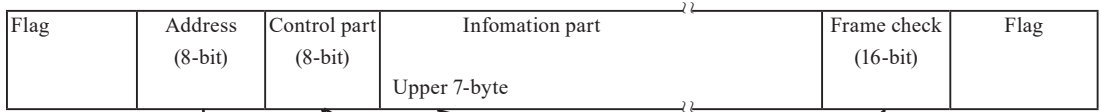

### Translation display

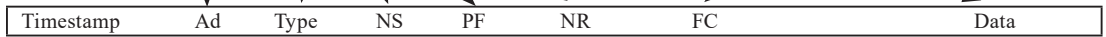

### SDLC mnemonics chart (modulo 8)

Mnemonic		Name		Control bit configuration							
SD side	RD side	SD side	RD side	b8	b7	b6	b5	b4	b3	b2	b1
INFO	INFO	INFOmation		N(R)		P/F	N(S)			0	
RR	RR	Receive Ready		N(R)		P/F	0	0	0	1	
RNR	RNR	Recieve Not Ready		N(R)		P/F	0	1	0	1	
REJ	REJ	REJect		N(R)		P/F	1	0	0	1	
SNRM		Set Normal Responce Mode		1	0	0	P	0	0	1	1
SNRME		Set Normal Response ModeExtended		1	1	0	P	1	1	1	1
DISC	RD	DISConnect	Request Disconnect	0	1	0	P/F	0	0	1	1
SIM	RIM	Set Initialization Mode	Request Initialization Mode	0	0	0	P/F	0	1	1	1
	DM	Disconnect Mode		0	0	0	F	1	1	1	1
UP		Unnumbered Poll		0	0	1	P	0	0	1	1
	UA	Unnumbered Acknowledgement		0	1	1	F	0	0	1	1
UI	UI	Unnumbered IDentification		0	0	0	P/F	0	0	1	1
XID	XID	eXchange IDentification		1	0	1	P/F	1	1	1	1
	FRMR	FReMe Reject		1	0	0	F	0	1	1	1
TEST	TEST	TEST		1	1	1	P/F	0	0	1	1
	BCN	BeaCoN		1	1	1	F	1	1	1	1
CFGR	CFGR	ConFiguRe		1	1	0	P/F	0	1	1	1

☞ When a control unit other than the above bit configuration is received, displayed in HEX.

### SDLC mnemonics chart (modulo 128)

Mnemonic	Name	Control bit configuration									
		b16-b10	b9	b8	b7	b6	b5	b4	b3	b2	b1
INFO	INFOmation	N(R)	P/F	N(S)						0	
RR	Receive Ready	N(R)	P/F	0	0	0	0	0	0	0	1
RNR	Recieve Not Ready	N(R)	P/F	0	0	0	0	0	1	0	1
REJ	REJect	N(R)	P/F	0	0	0	0	1	0	0	1

☞ When a control unit other than the above bit configuration is received, displayed as in modulo 8.

■ X.25 mnemonics chart (modulo 8)

Mnemonic		Name		Control bit configuration							
SD side	RD side	SD side	RD side	b8	b7	b6	b5	b4	b3	b2	b1
INFO	INFO	INFOmation		N(R)			P/F	N(S)			0
RR	RR	Receive Ready		N(R)			P/F	0	0	0	1
RNR	RNR	Recieve Not Ready		N(R)			P/F	0	1	0	1
REJ	REJ	REJect		N(R)			P/F	1	0	0	1
SARM	DM	Set Asynchronous Responce Mode	Disconnect Mode	0	0	0	P/F	1	1	1	1
SABM		Set Asynchronous Balanced Mode		0	0	1	P	1	1	1	1
SABME		Set Asynchronous Balanced ModeExtended		0	1	1	P	1	1	1	1
DISC		DISConnect		0	1	0	P	0	0	1	1
	UA	Unnumbered Acknowledgement		0	1	1	F	0	0	1	1
	FRMR	FRaMe Reject		1	0	0	F	0	1	1	1

☰ When a control unit other than the above bit configuration is received, displayed in HEX.

■ X.25E mnemonics chart (modulo 128)

Mnemonic		Name		Control bit configuration							
SD side	RD side	SD side	RD side	b8	b7	b6	b5	b4	b3	b2	b1
INFO	INFO	INFOmation		N(S)							0
				N(R)							PF
RR	RR	Receive Ready		0	0	0	0	0	0	0	1
				N(R)							P
RNR	RNR	Recieve Not Ready		0	0	0	0	0	1	0	1
				N(R)							PF
REJ	REJ	REJect		0	0	0	0	1	0	0	1
				N(R)							PF

☰ When a control unit other than the above bit configuration is received, displayed as in modulo 8.

### ■ LAPD frame composition

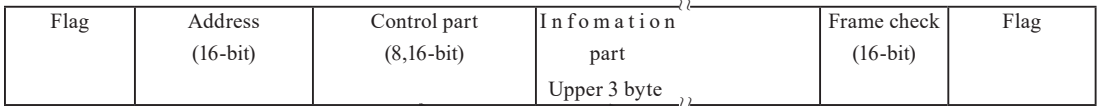

### ■ Translation display



### ■ LAPD mnemonics chart

Mnemonic		Name		Control bit configuration								
SD side	RD side	SD side	RD side	b8	b7	b6	b5	b4	b3	b2	b1	
INFO		INFOmation		N(S)								0
				N(R)								P
RR	RR	Receive Ready		0	0	0	0	0	0	0	1	
				N(R)								P/F
RNR	RNR	Recieve Not Ready		0	0	0	0	0	1	0	1	
				N(R)								P/F
REJ	REJ	REJect		0	0	0	0	1	0	0	1	
				N(R)								P/F
SABME		Set Asynchronous BalancedMode Extended		0	1	1	P	1	1	1	1	
				DM		Disconnected Mode	0	0	0	F	1	1
UI		Unnumbered Infomation		0	0	0	P	0	0	1	1	
DISC		DISConnect		0	1	0	P	0	0	1	1	
	UA		Unnumbered Acknowledgement	0	1	1	F	0	0	1	1	
	FRMR		FRaMe Reject	1	0	0	F	0	1	1	1	
XID	XID	eXchange IDentification		1	0	1	P/F	1	1	1	1	

☞ When a control unit other than the above bit configuration is received, displayed in HEX.

■ X.25 packet composition

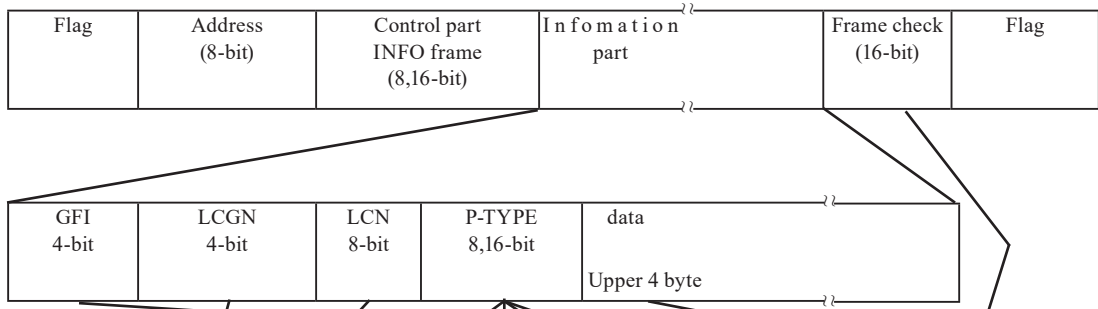

■ Translaion display



■ X.25 mnemonics chart

Mnemonic		Name		Control bit configuration							
SD side	RD side	SD side	RD side	b8	b7	b6	b5	b4	b3	b2	b1
DT	DT	Data		P(R)		M	P(S)			0	
RR	RR	Receiver Ready		P(R)		0	0	0	0	1	
RNR	RNR	Receve Not Ready		P(R)		0	0	1	0	1	
REJ		REJect		P(R)		0	1	0	0	1	
CR	IC	Call Request	Incoming Call	0	0	0	0	1	0	1	1
CA	CC	Call Accept	Call Connected	0	0	0	0	1	1	1	1
CQ	CI	Clear reQuest	Clear Indication	0	0	0	1	0	0	1	1
CF	CF	Clear conFirmation		0	0	0	1	0	1	1	1
SQ	SI	reStart reQuest	reStart Indication	1	1	1	1	1	0	1	1
SF	SF	reStart conFirmation		1	1	1	1	1	1	1	1
RQ	RI	Reset reQuest	Reset Indication	0	0	0	1	1	0	1	1
RF	RF	Reset conFirmation		0	0	0	1	1	1	1	1
REGQ		REGister(Facility)reQuest		1	1	1	1	0	0	1	1
	REGF	REGister(Facility) conFirmation		1	1	1	1	0	1	1	1
IT	IT	InTerrupt		0	0	1	0	0	0	1	1
IF	IF	Interrupt conFirmation		0	0	1	0	0	1	1	1
DIAG	DIAG	DIAGnostic		1	1	1	1	0	0	0	1

■ LAPD packet configuration

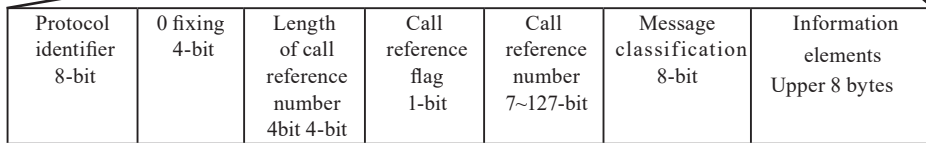
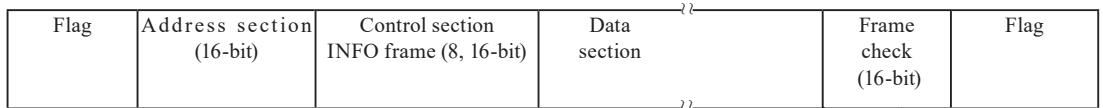

■ Translation screen



■ LAPD mnemonics chart

Mnemonics	Name	Bit configuration of message							
		b8	b7	b6	b5	b4	b3	b2	b1
ESCAPE	ESCAPE	0	0	0	0	0	0	0	0
ALERT	ALERTing	0	0	0	0	0	0	0	1
CALL PROC	CALL PROCeeding	0	0	0	0	0	0	1	0
CONN	CONNect	0	0	0	0	0	1	1	1
CON NACK	CONNect ACKnowledge	0	0	0	0	1	1	1	1
PROG	PROGress	0	0	0	0	0	0	1	1
SETUP	SETUP	0	0	0	0	0	1	0	1
SETUP ACK	SETUP ACKnowledge	0	0	0	0	1	1	0	1
RES	RESume	0	0	1	0	0	1	1	0
RES ACK	RESume ACKnowledge	0	0	1	0	1	1	1	0
RES REJ	RESume REJect	0	0	1	0	0	0	1	0
SUSP	SUSPend	0	0	1	0	0	1	0	1
SUSP ACK	SUSPend ACKnowledge	0	0	1	0	1	1	0	1
SUSP REJ	SUSPend REJect	0	0	1	0	0	0	0	1
USER INFO	USER INFORMATION	0	0	1	0	0	0	0	0
DISC	DISConnect	0	1	0	0	0	1	0	1
REL	RELease	0	1	0	0	1	1	0	1
REL COMP	RELease COMPlEte	0	1	0	1	1	0	1	0
REST	REStart	0	1	0	0	0	1	1	0
REST ACK	REStart ACKnowledge	0	1	0	0	1	1	1	0
SEGMENT	SEGMENT	0	1	1	0	0	0	0	0
CON CON	CONgestion CONtrol	0	1	1	1	1	0	0	1
INFO	INFORmation	0	1	1	1	1	0	1	1
FAC	FACility	0	1	1	0	0	0	1	0
NOTIFY	NOTIFY	0	1	1	0	1	1	1	0
STATUS	STATUS	0	1	1	1	1	1	0	1
STATUS EN	STATUS ENqiry	0	1	1	1	0	1	0	1

■ PPP frame constitution

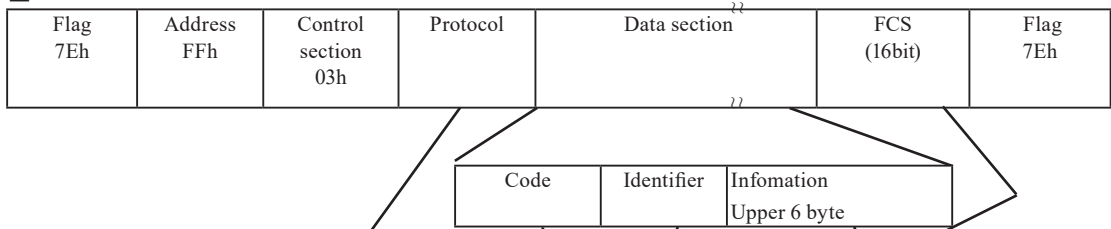

■ Translation screen

TimeStamp	PROTOCOL	CODE	ID	FC	Data
-----------	----------	------	----	----	------

Protocol value (h)	Mnemonic	Name
0001	Padding	Padding Protocol
0021	IP	Internet Protocol
0023	OSI	OSI Network Layer
0025	XNS	Xerox NS IDP
0027	DECnet	DECnet Phase IV
0029	AT	AppleTalk
002b	IPX	Novell IPX
002d	VJCTCPIP	Van jacobson Compressed TCP/IP
002f	VJUTCPIP	Van jacobson Uncompressed TCP/IP
0031	BPDU	Bridging PDU
0033	ST	Stream Protocol (TS-II)
0035	VINES	Banyan Vines
0039	AT-EDDP	AppleTalk EDDP
003b	AT-SB	AppleTalk SmartBuffered
003d	MP	Multi-Link
003f	NETBIOS	NETBIOS Framing
0041	Cisco	Cisco Systems
0043	Ascom	Ascom Timeplex
0045	LBLB	Fujitsu Link Backup and Load Barancing
0047	DCA	DCA Remote Lan
0049	SDTP	Serial Data Transport Protocol (PPP-SDTP)
004b	SNA802.2	SNA over 802.2
004d	SNA	SNA
004f	IPv6	IPv6 Header Compression
006f	SB	Stampede Bridging
00fb	CSLMG	Compression on single link in multilink group
00fd	1stComp	1st choice compression

Protocol value (h)	Mnemonic	Name
0201	802.1dHP	802.1d Hello Packet
0203	SR-BPDU	IBM Source Routing BPDU
0205	DECLBST	Dec LANBridge 100 Spanning Tree
0231	Luxcom	Luxcom
233	SigmaNS	Sigma Network Systems
8021	IPCP	Internet Protocol Control Protocol
8023	OSINLCP	OSI Network Layer Control Protocol
8025	XNSCP	Xerox NS IDP Control Protocol
8027	DNCP	DECnet Phase IV Control Protocol
8029	ATCP	Apple Talk Control Protocol
802b	IPXCP	Novell IPX Control Protocol
8031	BCP	Bridging NCP
8035	BVCP	Banyan Vines Control Protocol
803d	MPCP	Multi-Link Control Protocol
803f	NETBIOSC	NETBIOS Framing Control Protocol
8041	CiscoCP	Cisco Systems Control Protocol
8043	AscomCP	Ascom Timeplex
8045	LBLBCP	Fujitsu LBLB Control Protocol
8047	DCA-CP	DCA Remote Lan Network Control Protocol
8049	SDCP	Serial Data Control Protocol (PPP-SDCP)
804b	SNA802CP	SNA over 802.2 Control Protocol
804d	SNACP	SNA Control Protocol
804f	IPv6CP	IPv6 Header Compression Protocol
806f	SBCP	Stampede Bridging Control Protocol
80fb	CSLMGCP	Compression on single link in multilink group control
80fd	CCP	Compression Control Protocol
c021	LCP	Link Control Protocol
c023	PAP	Password Authentication Protocol
c025	LQR	Link Quality Report
c027	SPAP	Shiva Password Authentication Protocol
c029	CBCP	CallBack Control Protocol (CBCP)
c223	CHAP	Challenge Handshake Authentication Protocol
c26f	SBAP	Stampede Bridging Authorization Protocol
c281	PropAP	Proprietary Authentication Protocol
c481	PropNIDA	Proprietary Node ID Authentication Protocol

Code	Mnemonic	Meaning
01	CONF-REQ	Configure-Request
02	CONF-ACK	Configure-Ack
03	CONF-NAK	Configure-Nak
04	CONF-REJ	Configure-Reject
05	TERM-REQ	Terminate-Request
06	TERM-ACK	Terminate-Ack
07	CODE-REJ	Code-Reject
08	PROT-REJ	Protocol-Reject
09	ECHO-REQ	Echo-Request
0A	ECHO-REP	Echo-Reply
0B	DISC-REQ	Discard-Request
0C	IDENT	Identification
0D	TIME-REM	Time-Remaining
0E	RES-REQ	Reset-Request
0F	RES-REP	Reset-Reply

◆ This unit translates all bits of ACCM as “0”.

(Example) When all the ACCMs between communication devices are bit ON (1)

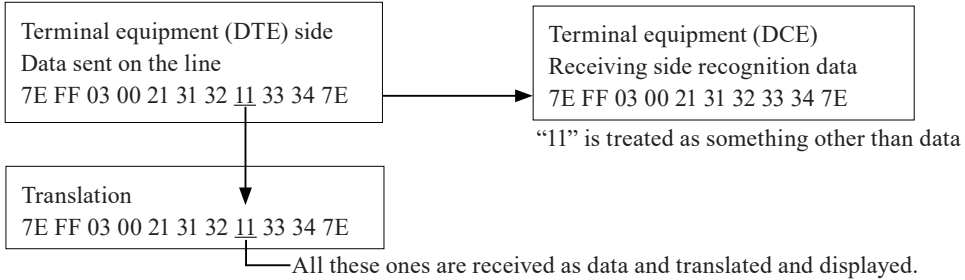

As shown in the figure above, when the data actually flowing on the line is (7E FF 03 00 21 31 32 11 33 34 7E), 11 of the data received by the receiving side is processed as something other than data, but this analyzer translates 11 as data.

■ Function code

Code	Display	Description
0x01	Read coils	Read Coils
0x02	Read discrete inputs	Read Discrete inputs
0x03	Read holding registers	Read Holding Registers
0x04	Read input registers	Read Input Registers
0x05	Write single coil	Write Single Coil
0x06	Write single register	Write Single Register
0x07	Read exception status	Read Exception Status
0x08	Diagnostics	Diagnostics
0x0B	Get comm event counter	Get Comm Event Counter
0x0C	Get comm event log	Get Comm Event Log
0x0F	Write multiple coils	Write Multiple Coils
0x10	Write multiple registers	Write Multiple registers
0x11	Report slave ID	Report Slave ID
0x14	Read file record	Read File Record
0x15	Write file record	Write File Record
0x16	Mask write register	Mask Write Register
80x17	R-W multiple registers	Read/Write Multiple registers
0x18	Read FIFO queue	Read FIFO queue
0x2B	Encapsulated	Encapsulated Interface Transport

■ Sub-function code

Code	Sub-function (Diagnostics)	Description
0x00	Diag/Query data	Return Query Data
0x01	Diag/Restart comm	Restart Communications Option
0x02	Diag/Diagnostic register	Return Diagnostic Register
0x03	Diag/ ASCII delimiter	Change ASCII Input Delimiter
0x04	Diag/Force listen only	Force Listen Only Mode
0x0A	Diag/Clear counters	Clear Counters and Diagnostic Register
0x0B	Diag/Bus msg count	Return Bus Message Count
0x0C	Diag/Bus comm err cnt	Return Bus Communication Error Count
0x0D	Diag/Bus except err cnt	Return Bus Exception Error Count
0x0E	Diag/Slave msg count	Return Slave Message Count
0x0F	Diag/Slave no res count	Return Slave No Response Count
0x10	Diag/Slave NAK count	Return Slave NAK Count
0x11	Diag/Slave busy count	Return Slave Busy Count
0x12	Diag/Bus overrun count	Return Bus Character Overrun Count
0x14	Diag/Clear overrun	Clear Overrun Counter and Flag

Code	Sub-function (Encapsulated)	Description
0x0D	Enca/CANopen general	CANopen General Reference Request and Response PDU
0x0E	Enca/Read device ident	Read Device Identification

# Chapter 11 Specifications and Maintenance

## 11.1 Specifications of Function and Hardware

Model		LE-3500XR(V2)	LE-2500XR(V2)
Standard Interface	RS-232C (V. 24)	◎	
	RS-422/485	◎	
	TTL/I2C/SPI	◎	
Expansion Interface <sup>(*)1</sup>	X. 20/21	○ OP-SB10N + [LE-25Y15]	
	RS-449	○ OP-SB10N + [LE-25Y37]	
	V. 35	○ OP-SB10N + [LE-25M34]	
	TTL(USART)	○ [OP-SB5GL]	
	Current Loop	○ [ OP-SB1C ]	
	CAN/CAN FD/CXPI	○ [ OP-SB7XC]	
	CAN/CAN FD/LIN	○ [ OP-SB7XL]	
Expansion Firmware <sup>(*)1</sup>	High Speed HDLC/SPI	○ [OP-FW10XR]	Not Supported
Standard Protocol	Asynchronous Asynchronous PPP	◎	
	Character synchronous SYNC/ BSC	◎	
	Bit synchronous HDLC/SDLC/X. 25	◎	
	MODBUS	◎	Not Supported
	I2C	◎	
	SPI	◎	
	Burst <sup>(*)2</sup>	◎	
Expansion Protocol	CAN/CAN FD	○	
	Device Net <sup>(*)3</sup>	○	
	LIN	○	
	CXPI	○	
	CC-Link <sup>(*)3</sup>	○	△ 1Mbps or less only
Capture Memory	Memory capacity <sup>(*)4</sup>	DDR3-SDRAM 100M Byte	2 split available
Transmission speed	Max speed in full-duplex	2.048Mbps	1.000Mbps
	Max speed in half-duplex	3.150Mbps	1.544Mbps
	Speed setting range <sup>(*)5</sup>	50bps ~ 3.150Mbps	50bps ~1.544Mbps
	Setting step	Freely set to four effective digits, separately for transmission and reception. (Margin of error: +/- 0.01% or less)	
Online monitor function	Communication log is recorded continuously and displayed in the CD without affecting the communication lines. Displays idle time, time stamps and line state etc.		
Line Status LED	SD, RD, RS, CS, ER, DR, CD, CI, ST1, ST2, RT		
Signal Voltage Measurement	Voltage measurement of SD, RD, ER(DTR), and CD(DCD) of the RS-232C port. Voltage measurement of TXD, RXD, RTS, CTS of the TTL port RS-232C input range±18V, TTL input range -1V ~ 6V Resolution 0.1V		
Statistical analysis function	◎		-
Analogue measurement function			
Analogue pod OP-8AH (optional)	Number of channels: 8, built-in 24-bit resolution ADC, screwless terminal block		
Input impedance	1MΩ, withstand voltage: max.±65Vpk.		
withstand voltage	GND common between channels, non-isolated		
Input range	±60V, ±30V, ±16V, ±8V, ±4V		
Measurement accuracy <sup>*9</sup>	±60V range, ±30V range, ±16V range : ±(0.1% rdg + 3mV)±8V range, ±4V range : ±(0.1% rdg + 2mV)		

Model		LE-3500XR(V2)	LE-2500XR(V2)
Analog pod OP-8AT (optional)		Number of channels: 8, 24-bit resolution, built-in highprecision ADC,	
Input impedance		1M $\Omega$ , withstand voltage: max $\pm$ 50Vpk	
voltage resistance		$\pm$ 60V, $\pm$ 30V, $\pm$ 16V, $\pm$ 8V, $\pm$ 4V	
Signal isolation voltage		Between analog input and analyzer 1500V (AC peak/DC)	
Input range *10		Between each channel of analog input 350V (AC peak/DC)	
Measurement accuracy *11		$\pm$ 30V, $\pm$ 10V, $\pm$ 1V, $\pm$ 100mV, 0-20mA, temperature K, J, T, E, N,R, S, B type thermocouple compatible	
		$\pm$ 30V range $\pm$ (0.05% rdg + 3mV),	
		$\pm$ 10V range $\pm$ (0.05% rdg + 2mV),	
		$\pm$ 1V range $\pm$ (0.05% rdg + 0.2mV),	
		$\pm$ 100mV range $\pm$ (0.05% rdg + 50 $\mu$ V),	
		0-20mA current range $\pm$ 0.05% FS,	
		Temperature range: See below table	
Logic analyzer function		1KHz to 50MHz ( 15 steps ) (*5) 4,096 samplings	
Bit error rate test		Measure error rate conforming to ITU-T Notification G.821 parameter.	
Simulation function	Operation Spec	Enables transmission/ reception test of any given data in DTE or DCE mode (selectable with pin arrangements).	
	MANUAL	⊙	
	FLOW	⊙	
	ECHO	⊙	
	POLLING	⊙	
	BUFFER	⊙	-
PROGRAM	⊙	-	
Wi-Fi interface (*6)	IEEE802.11b/g/n	Frequency range : 2400MHz-2483.5MHz TX POWER: +20dBm(802.11b), +17dBm(802.11g), +14dBm(802.11n)	
LCD display		4.3 inch TFT color display (480x272dot)	
USB2.0 device port		USB Type-C connector, High speed transmission supported, for PC connection	
USB2.0 host port		Standard A connector, High speed (*7)	
SD card slot		Supports SDHC card (*8). Conforms to the SD association standard.	
Power		USB bus power 5V/1A Attached USB charger input: AC100 to 240V, 50/60Hz	
Built-in secondary battery		Lithium-ion secondary battery (model: P-26LS1) Battery Charge Time Quick charge: about 3.5 hours, Normal charge: about 6 hours Lithium-ion rechargeable battery operation time: about 7 hours(*9)	
Temperature		In operation : 0 ~ 40°C In storage : -10 ~ 50°C	
Humidity		5 ~ 85%RH (no condensation)	
Regulatory Approvals		CE ( class A )	
Dimensions (W×D×H)		190(W)×153(D)×38(H) mm	
Weight		Approx. 550g	

\*1 : Supported with option product in [ ].

\*2 : Mode in which all data is imported in synch with clock edge

\*3 : Raw data display only. High-speed CC-Link requires extended firmware OP-FW10XR.

\*4 : Transmission/ reception data, idle time, time stamp, and line state consume 4 bytes of memory at each capture.

\*5 : Firmware Ver.1.04 or later

\*6 : Wi-Fi function is available only in Japan, USA, Canada, and EU nations where the product is needed to be compliant with RE directive (2014/53/EU). The Wi-Fi function of this product is set to invalid depending on the country where it is shipped. Please contact LINEEYE for the detail.

\*7 : For a USB memory or dedicated printer. Not all USB memory devices and printers are supported.

\*8 : SDHC cards other than our optional products are not supported.

\*9 : rdg represents the accuracy of the reading.

\*10 : For the 0-20mA range, an external current detection resistor (250 $\Omega$  or 50 $\Omega$ , accuracy $\pm$ 0.1% or less) is required on the input terminal block.

\*11 : rdg represents the accuracy for the reading value, and FS represents the accuracy for the full scale of the range. Current accuracy does not include external resistance errors.

OP-8AT (optional) temperature measurement specifications		
Compatible thermocouple	K, J, T, E, N, R, S, B Type	
Measurement temperature range	K Type : -200°C ~ 1370°C J Type : -210°C ~ 1200°C T Type : -200°C ~ 400°C E Type : -200°C ~ 1000°C N Type : -200°C ~ 1300°C R Type : 0°C ~ 1760°C S Type : 0°C ~ 1760°C B Type : 400°C ~ 1800°C	
Cold junction compensation	Internal compensation, external compensation switchable	
Disconnection detection function	On/off switchable (applied current: approx. 180nA)	
Measurement accuracy*1	K Type	-50°C ~ 1370°C : ±(0.05% rdg + 1.0°C) -200°C ~ -50°C : ±(0.05% rdg + 2.0°C)
	J Type	-50°C ~ 1200°C : ±(0.05% rdg + 0.8°C) -210°C ~ -50°C : ±(0.05% rdg + 1.6°C)
	T Type	-50°C ~ 400°C : ±(0.05% rdg + 1.0°C) -200°C ~ -50°C : ±(0.05% rdg + 2.0°C)
	E Type	-50°C ~ 1000°C : ±(0.05% rdg + 0.6°C) -200°C ~ -50°C : ±(0.05% rdg + 1.2°C)
	N Type	-50°C ~ 1300°C : ±(0.05% rdg + 1.5°C) -200°C ~ -50°C : ±(0.05% rdg + 3.0°C)
	R Type	400°C ~ 1760°C : ±(0.05% rdg + 3.5°C)
	S Type	0°C ~ 400°C : ±(0.05% rdg + 6.0°C)
	B Type	800°C ~ 1800°C : ±(0.05% rdg + 4.0°C) 400°C ~ 800°C : ±(0.05% rdg + 7.5°C)
	Cold junction compensation accuracy*2	± 1.0°C

\*1 : Accuracy at ambient temperature of 18 to 28°C and after 20 minutes after power on, does not include thermocouple error.  
If the above ambient temperature range is exceeded, add 1/20 of each error value for every 1°C.

\*2 : In environments where a part of the measurement pod is locally heated or cooled, cold junction compensation accuracy cannot be guaranteed.

## 11.2 Signal Definition of the Measurement Ports

### ○ RS-232C(V.24) port

RS-232C measurement/test port. The standard pin assignment is V.24 specification.

The input/output specifications of each signal can be switched by setting of DTE/DCE at the monitor function (MONITOR), simulation function, and BERT function.

#### ■ Signal definition of the RS-232C

Name	RS-232C(V.24)		Input/Output <sup>(*)3</sup>			Line state LED
	DSUB25	Pin <sup>(*)2</sup>	MONITOR	DTE	DCE	
Shield grand	FG	1	-	-	-	
Signal grand	SG	7	-	-	-	
Transmitted data	TXD	2	I	O	I	SD
Received data	RXD	3	I	I	O	RD
Request to send	RTS	4	I	O	I	RS
Clear to send	CTS	5	I	I	O	CS
Data terminal ready	DTR	20	I	O	I	ER
Data set ready	DSR	6	I	I	O	DR
Data carrier detect	DCD	8	I	I	O	CD
Ring indicator	RI <sup>(*)1</sup>	22	I	I	-	CI
Send timing DTE	TXC1	24	I	O	I	ST1
Send timing DCE	TXC2	15	I	I	O	ST2
Receive timing DCE	RXC	17	I	I	O	RT

\*1: RI signals cannot be output from this unit.

\*2: Pins not mentioned are not connected.

\*3: Input direction to this analyzer is I, output direction from this analyzer is O.

### ○ RS-422/485 port

RS-422/485 measurement/test port.

#### ■ Signal definition of RS-422/485 port

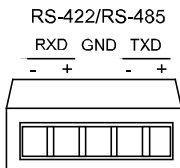

Signal	Terminal	Input/Output <sup>(*)1</sup>			Line state LED
		MONITOR	DTE	DCE	
Transmission data	TXD-	I	O	I	SD
	TXD+	I	O	I	
Receiving data	RXD-	I	I	O	RD
	RXD+	I	I	O	
Signal Ground	GND	-	-	-	

\*1: "I" is an input to the analyzer. "O" is an output from the analyzer.

## ○ TTL Port

TTL (UART), SPI, and I2C port for measurement and test

☰ In analog measurement mode, the port will switch to an analog pod connection port.

Do not connect any other than the compatible pod, as the specifications will be different from those described here.

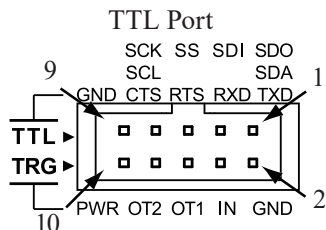

Connector : 2.54mm pitch Pin header type  
HIF3FC-10PA-2.54DS(71)  
HIROSE ELECTRIC

### ■ TTL (UART) signal definition

Signal	Pin name	Pin	Input/Output <sup>(*)</sup>		Line state LED
			MONITOR	SIMULATION	
Transmission data	TXD	1	I	O	SD
Receiving data	RXD	3	I	I	RD
RTS	RTS	5	I	O	RS
CTS	CTS	7	I	I	CS
Signal Ground	GND	9	-	-	

### ■ I2C

Signal	Pin name	Pin	Input/Output <sup>(*)</sup>			Line state LED
			MONITOR	SIMULATION		
				MASTER	SLAVE	
SDA	SDA	1	I	I/O	I/O	SD
SCL	SCL	7	I	O	I	ST1
Signal Ground	GND	9	-	-		

### ■ SPI

Signal	Pin name	Pin	Input/Output <sup>(*)</sup>			Line state LED
			MONITOR	SIMULATION		
				MASTER	SLAVE	
MOSI	SDO	1	I	O	O <sup>(*)2</sup>	SD
MISO	SDI	3	I	I	I <sup>(*)2</sup>	RD
SS	SS	5	I	O	I	RS
SCK	SCK	7	I	O	I	ST1
Signal Ground	GND	9	-	-		

### ■ Signal definition of the external trigger

Signal	Pin name	Pin	Input/Output <sup>(*)</sup>	Signal level
External trigger input	IN	4	I	LVTTTL (3.3V)
External trigger output1	OT1	6	O	open collector 5V pull-up
External trigger output2	OT2	8	O	open collector 5V pull-up
Power for the external circuit	PWR	10	O	TTL voltage output <sup>(*)3</sup>

\*1 : "I" is an input to the analyzer. "O" is an output from the analyzer

\*2 : For SLAVE simulation, connect the SDO of this unit to the MISO to be tested and the SDI of this unit to the MOSI to be tested.

\*3 : When the measurement port is set to TTL and the simulation is executed, the set TTL voltage is output (max. 30mA)

○ RS-530 port [when using optional board OP-SB10N]

This port can support legacy interfaces such as X.21, RS-449, V.35, etc. by using a dedicated cable.

■ Signal definition of the RS-530 (RS-422/485) port

Signal	RS-530		X.20/21 <sup>(*1)</sup>		RS-449 <sup>(*2)</sup>		V.35 <sup>(*3)</sup>		Line state LED
	Dsub25	Pin	Dsub15	Pin	Dsub37	Pin	M type 34	Pin	
Shield ground	FG	1	FG	1	FG	1	FG	A	
Transmission data	TXD[A]:-	2	T [A]:-	2	SD[A]:-	4	TXD[A]:-	P	SD
	TXD[B]:+	14	T [B]:+	9	SD[B]:+	22	TXD[B]:+	S	
Receiving data	RXD[A]:-	3	R [A]:-	4	RD[A]:-	6	RXD[A]:-	R	RD
	RXD[B]:+	16	R [B]:+	11	RD[B]:+	24	RXD[B]:+	T	
Request to send	RTS[A]:-	4	C [A]:-	3	RS[A]:-	7			RS
	RTS[B]:+	19	C [B]:+	10	RS[B]:+	25			
Clear to send	CTS[A]:-	5	I [A]:-	5	CS[A]:-	9			CS
	CTS[B]:+	13	I [B]:+	12	CS[B]:+	27			
Data set ready	DSR[A]:-	6			DM[A]:-	11	V_DSR	E	DR
	DSR[B]:+	22			DM[B]:+	29			
Terminal ready	DTR[A]:-	20			TR[A]:-	12	V_DTR	H	ER
	DTR[B]:+	23			TR[B]:+	30			
Signal ground	SG	7	SG	8	SG	19	SG	B	
Data carrier Di- tect	DCD[A]:-	8			RR[A]:-	13	V_DCD	F	CD
	DCD[B]:+	10			RR[B]:+	31	V_CI	J	CI
Transmission timing DTE	TXC1[A]:-	24			TT[A]:-	17	TXC1[A]:-	U	ST1
	TXC1[B]:+	11			TT[B]:+	35	TXC1[B]:+	W	
Transmission timing DCE	TXC2[A]:-	15			ST[A]:-	5	TXC2[A]:-	Y	ST2
	TXC2[B]:+	12			ST[B]:+	23	TXC2[B]:+	AA	
Receiving timing DCE	RXC[A]:-	17	S [A]:-	6	RT[A]:-	8	RXC[A]:-	V	RT
	RXC[B]:+	9	S [B]:+	13	RT[B]:+	26	RXC[B]:+	X	
	V.35 RTS	18					V_RTS	C	RS
	V.35 CTS	21					V_CTS	D	CS
Not connected		25							

\*1 : DSUB 15pin connector signal definition when using the X.21 monitor cable LE-25Y15 (option).

When using this cable, set the “Clock” of configuration to “RT” or “AR”.

\*2 : DSUB 37pin connector signal definition when using the RS-449 monitor cable LE-25Y37 (option) when using the same cable DSUB37pin connector signal definition

\*3 : M type 34pin connector signal definition when using the V.35 monitor cable LE-25M34 (option).

When using this cable, enable “V.35 mode” at the Interface setting.

○ Synchronous TTL port [ when using optional board OP-SB5GL ]

■ Signal definition of the probe unit

Signal	Description	Probe color	Line state LED
Signal ground	GND	Black	
Transmission data /SPI/I2C	SD / SDO / SDA	Brown	SD
Receiving data /SPI	RD / SDI	Red	RD
Control line RTS /SPI	RTS / SS	Orange	RS
TTL Control line CTS	CTS	Yellow	CS
TTL external signal input	EXIN	Green	CI
Transmission synchronous clock/SPI/I2C	TXC / SCK / SCL	Blue	ST1/ST2
Reception synchronous clock	RXC	Purple	RT
External trigger input	TRG. IN	Gray	
Signal ground	GND	Black	
External trigger output	TRG.OT	White	

<Probe pod>

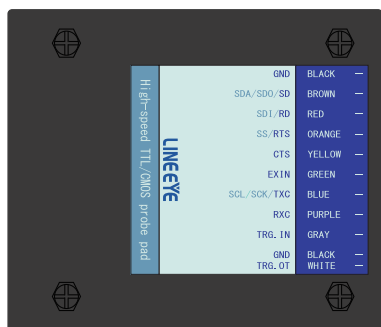

<Probe unit>

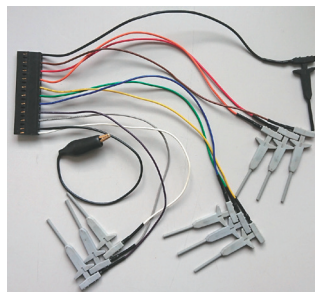

☰ The probe pod and the unit is included in OP-SB5GL.

○ Current loop measurement port [ when usinf optional board OP-SB1C ]

Signal	Terminal	Input/output	Line state LED
Transmission line current loop input	SI	I	SD
Transmission line current loop output	SO	O	
Reception line current loop input	RI	I	RD
Reception line current loop output	RO	O	

<Adapter for current loop>

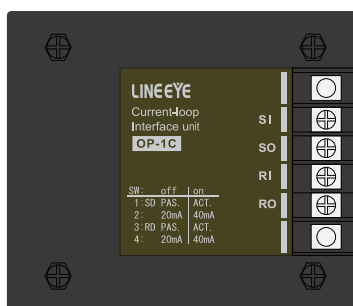

☰ The adapter for current loop is included in OP-SB1C.

## 11.3 Shortcut Keys

The shortcut key operation similar to the operation by the menu number of the conventional model is available. By pressing [0] to [F] after [MENU], you can move to the frequently used setting screen.

Shortcut key	Setting display	Remark
[MENU] and [0]	Configuration	
[MENU] and [1]	Interface	
[MENU] and [2]	Trigger	
[MENU] and [3]	Record Control	(*)
[MENU] and [4]	Waveform monitor setting	
[MENU] and [7]	Operation mode	(*)
[MENU] and [9]	Data table selection	
[MENU] and [A]	MANUAL mode detail setting	
[MENU] and [C]	File control	(*)
[MENU] and [D]	System setting	(*)
[MENU] and [E]	Clock setting	(*)
[MENU] and [F]	Program edit display of the PROGRAM mode	

- ☰ If the transition destination setting screen is not valid for the current function or operation mode, such as pressing the [MENU] or [9] key in monitor function, the operation will be ignored.
- ☰ Please note that the shortcut key operation with (\*) is different from the operation by the menu number of the conventional model.

## 11.4 Software Reset

By the software reset operation, you can initialize the internal status of this analyzer and return the settings to the factory settings.

### ■ How to

While the power is off, turn on the power pressing [ENTER]+[TOP/DEL]. “Initialized!!” message is displayed on the opening screen.

- ☰ The software reset also clears all measurement data in the capture memory.

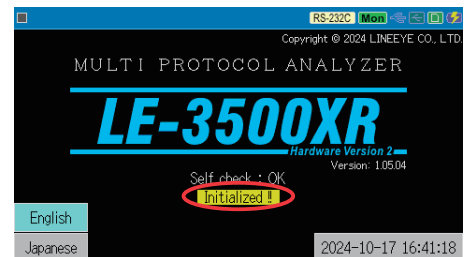

## 11.5 Firmware Update

---

The latest improved firmware can be downloaded from the LINE EYE website.  
[https://www.lineeye.com/html/download\\_update.html](https://www.lineeye.com/html/download_update.html)

Download it to an appropriate folder on your computer, unzip it, and check the firmware file (extension: FW2).

The downloaded firmware can be written to the analyzer in two ways.

### ■ By the firmware transfer software

- 1) Connect the analyzer and computer with a USB cable.
- 2) Copy the firmware transfer software le8firm.exe contained in the “Utility” folder of the attached CD to an appropriate folder and double-click to start it.
- 3) Select “USB” at “ Method” and confirm that the serial number of the analyzer is displayed in “Serial No.”
- 4) Turn on the power while holding down [SHIFT] and [STOP] on the analyzer to start the loader.
- 5) Click [Next] of the firmware transfer software, click [Select] to select the firmware file (extension: FW2) to be transferred, and click [Next].
- 6) Click [Start] here to start the transfer. When “Transmission and writing of the firmware were completed.” is displayed, click [Close] to quit the software. Turn the analyzer off and then turn on again, and check that the updated firmware version is displayed on the opening screen.

### ■ By using a storage device

- 1) Copy the firmware file (extension: FW2) to a storage device (USB flash drive or SDHC card).
- 2) Turn on the power while holding down [SHIFT] and [STOP] on the analyzer to start the loader.
- 3) Insert the storage device with the copied firmware file into the analyzer.
- 4) The loader screen will show the firmware file selection number.
- 5) Press the numeric key of the selection number and press [ENTER] to start the transfer.
- 6) When “?” is displayed after “Firmware write succeeded.”, the writing is complete. Turn the analyzer off and then turn on again, and check that the updated firmware version is displayed on the opening screen.

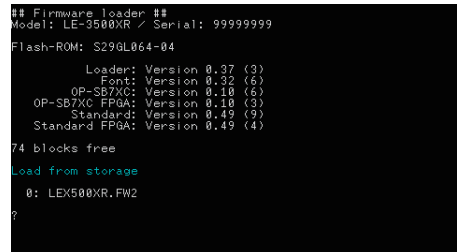

```
## Firmware loader ##
Model: LE-3500XR / Serial: 99999999
Flash-ROM: S29GL064-04
Loader: Version 0.37 (3)
Font: Version 0.32 (6)
OP-SB7XC: Version 0.10 (6)
OP-SB7XC FPGA: Version 0.10 (3)
Standard: Version 0.49 (9)
Standard FPGA: Version 0.49 (4)
74 blocks free
Load from storage
0: LEX500XR.FW2
?
```

## 11.6 Trouble shooting

■ This section describes how to solve problems when the analyzer does not operate normally.

Problem	Cause / Remedy
Cannot turn on the power. The power turns off immediately.	<ul style="list-style-type: none"> <li>When operating by the battery, fully charge it.</li> <li>If the attached USB charger is connected but it does not improve, it may be broken</li> </ul>
Unable to charge Unable to charge enough.	<ul style="list-style-type: none"> <li>If the BT LED is not lit, supply power by bus power.</li> <li>It cannot be charged at extremely low or high temperatures. Charge at 5 to 40°C.</li> <li>If the battery is fully charged but the power runs out shortly, the battery may be dead.</li> </ul>
The backlight turns on but it goes out immediately.	<ul style="list-style-type: none"> <li>Select the appropriate backlight automatic dimming time at “System Settings” of [MENU].</li> </ul>
##Firmware loader## is displayed.	<ul style="list-style-type: none"> <li>Set the sub board securely.</li> <li>Load the necessary firmware for the optional sub board used at the moment.</li> </ul>
The measurement data has disappeared. The communication condition settings have changed.	<ul style="list-style-type: none"> <li>By [RUN] operation the previous measurement data is delete. Please use the automatic backup function by the Auto save tab of “Record control” in [MENU].</li> <li>It may be caused because the life of the built-in lithium battery has run out. Please request replacement of the lithium battery.</li> </ul>
The date and time of the time stamp are incorrect.	<ul style="list-style-type: none"> <li>At the opening screen set the current date and time before measurement.</li> <li>If the date and time often go wrong, the built-in lithium battery may have run out.</li> </ul>
Keys does not work	<ul style="list-style-type: none"> <li>Key operation is not possible during internal processing such as access to storage device.</li> <li>Key operation is not possible while it is connected to PC link software LE-PC300R.</li> <li>Try again by disconnecting all cables under measurement.</li> <li>The response of the key becomes extremely slow when high-speed data (out of specification) is measured.</li> </ul>
Does not work properly. Some of the display is incorrect.	<ul style="list-style-type: none"> <li>Turn off the power and then turn it on again.</li> <li>Perform the soft reset (press [ENTER]+[TOP/DEL] when turning on the power). It returns to factory default setting. Please note that all data will be erased.</li> </ul>
Line state LED does not light	<ul style="list-style-type: none"> <li>Connect the cable correctly.</li> <li>Check if the spec of measurement target and settings at “Interface” of [MENU] match.</li> <li>Check if there is any broken wire or loose connector.</li> </ul>
The line state LED flashes, but can not monitor at all. Nothing is displayed.	<ul style="list-style-type: none"> <li>Select “On Line” monitor function.</li> <li>Set the communication conditions correctly at “Configuration” of [MENU]. Re-check the communication speed, synchronization clock and synchronization establishment character.</li> </ul>
The line state LED flashes, but cannot monitor properly. An error is displayed.	<ul style="list-style-type: none"> <li>Select the online monitor function.</li> <li>Set the communication conditions correctly at “Configuration” of [MENU].</li> <li>Re-check the data length, parity bit, FCS, and BCC.</li> </ul>
When [RUN] is executed, an error occurs in the monitored communication.	<ul style="list-style-type: none"> <li>Check if the simulation function is selected when monitoring. If the simulation function is selected, the output signals will collide.</li> </ul>
No data is output in simulation or BERT.	<ul style="list-style-type: none"> <li>Select simulation or BERT function.</li> <li>Select the settings correctly at “Interface” of [MENU].</li> <li>Set the communication conditions correctly at “Configuration” of [MENU]. Please check the sync clock again when using for SYNC or HDLC.</li> </ul>
The correct condition is not set by the auto configuration function	<ul style="list-style-type: none"> <li>It cannot be used when the communication speed of the target line exceeds the automatic detection speed.</li> <li>It may not be correctly determined depending on the communication data volume and bias.</li> </ul>
An SD card cannot be used on the analyzer	<ul style="list-style-type: none"> <li>Please use optional SD card from LINEEYE.</li> <li>Please use an SD card within the maximum SD card capacity.</li> </ul>
The Wi-Fi function cannot be used.	<ul style="list-style-type: none"> <li>Wi-Fi function is available only in Japan, USA, Canada and EU countries.</li> <li>Check if the Wi-Fi SSID and KEY are set correctly.</li> <li>Move to a location where radio waves can be easily received.</li> </ul>
Cannot connected to a computer via the USB port.	<ul style="list-style-type: none"> <li>Check if the connection is blocked by security softwares.</li> </ul>

## 11.7 Warranty and After service

---

### Warranty

---

- When you face any problems, please contact LINEEYE distributors or LINEEYE

- **Warranty**

Within a period of 12 months from the date of shipment, LINEEYE warrants that your purchased products (except consumable parts such as the battery and software) are free of charge from any defects in material and workmanship, only when the products are operated in accordance with procedures described in the documents supplied by LINEEYE. If the defects exist during the Warranty period, please send back the products to LINEEYE distributors or LINEEYE. LINEEYE will repair or exchange them at no charge. In this case, the shipping charge will be at your own expense.

The foregoing warranties are the sole warranties given by LINEEYE. Above warranties shall not be applied to the products that have been modified, repaired or altered (except by LINEEYE) or that have been subjected to unusual physical or electrical stress, misuses, abuse, negligence or accidents.

LINEEYE disclaims all other warranties including the warranties of merchantability fitness for some particular purpose and noninfringement of third party right. LINEEYE cannot promise that the software is error free or will operate without any interruption.

### User Registration

---

For after service and other information, please register in our Website.

### Repair

---

For malfunction, please contact LINEEYE distributors or LINEEYE and tell us following details.

Model	LE-2500XR(V2) or LE-3500XR(V2)
Serial Number	8 digit numbers
Purchase Date	Year, Month, Day
Other	Details of malfunction

 11.6 Trouble shooting

- **Repair during warranty period**  
LINEEYE repairs, following the repair instruction.  
Please provide the details of malfunction.
- **Repair after warranty period**  
LINEEYE will repair the products at our own expense.
- **Calibration**  
Enable to have a hardware calibration test by the line monitor.



## Maintenance parts

---

Maintenance parts such as lithium-ion batteries, attached cables, and AC adapters can be purchased from the store where you purchased the product or from our online shop.

### ■ About recycling of lithium-ion batteries

Please recycle the replaced old battery in accordance with the local laws and regulations of each country and the efforts of the battery-recycle promotion organization.



## After Support

---

Read “FAQ” in our Website or email us.

Please refer to “FAQ”. We also have support by email regarding the technical issue. When you use it, please register your product via our website.

Website : <https://www.lineeye.com>

## LINEEYE CO., LTD.

4F., Marufuku Bldg., 39-1, Karahashi Nishihiragaki-cho, Minami-ku,  
Kyoto, 601-8468, Japan

Tel : 075(693)0161 Fax : 075(693)0163

URL <https://www.lineeye.com> Email :[info@lineeye.co.jp](mailto:info@lineeye.co.jp)

Printed in Japan

M-35235XRV2E/LE